

# BOMBAS D'ÁGUA

*Bombas de Agua / Water Pumps*

# BOMBAS DE ÓLEO

*Bombas de Aceite / Oil Pumps*

# BOMBAS DE COMBUSTÍVEL

*Bombas de Combustible / Fuel Pumps*

# NAKATA®



# 2017

**Vehículos: Liviano y Pesado**

**Veículos: Leve e Pesado**

**Vehicles: Light and Heavy Duty**

Abril / 2017

# NAKATA®

flag

## AMORTECEDOR É HG A MAIS ALTA PERFORMANCE DO AZUL NAKATA.

### Exija a tecnologia líder em suspensão.

HG é mais que um amortecedor. É alta performance em pisos irregulares e curvas acentuadas. É segurança, é durabilidade, é a tecnologia do primeiro amortecedor pressurizado do Brasil. E também é o único com a força e a confiança do azul Nakata.



#### SISTEMA DE VEDAÇÃO DE ALTA RESISTÊNCIA = MAIS DURABILIDADE

Os materiais de borracha de alta performance e baixo atrito proporcionam maior resistência ao desgaste e às variações de temperatura, mantendo o perfeito funcionamento e evitando vazamentos.

#### TECNOLOGIA HIDROGÁS = MAIS DESEMPENHO

O nitrogênio à baixa pressão não deixa faltar óleo no ciclo de abertura da haste, evitando os "vazios" ou falhas no acionamento.

#### STOP HIDRÁULICO = MAIS CONFORTO

Suaviza os impactos no final do curso de abertura da suspensão em condições severas, melhorando o conforto do usuário.

#### VÁLVULA DE TRAÇÃO = MAIS CONTROLE

O ajuste preciso com o tubo de pressão proporciona uma movimentação suave. O sistema autorregulável, em três níveis de velocidade, oferece respostas rápidas de acordo com as condições da pista e condução do veículo.

#### VÁLVULA DE COMPRESSÃO = MAIS ESTABILIDADE

Fixada na parte inferior do tubo de pressão, garante a ação do amortecedor, proporcionando estabilidade e o conforto do veículo.

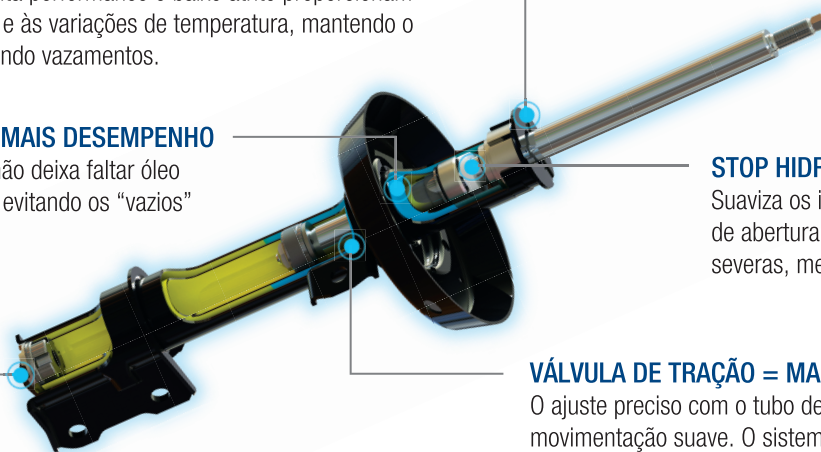

**TUDO AZUL. TUDO NAKATA.**



0800 707 80 22 • nakata.com.br

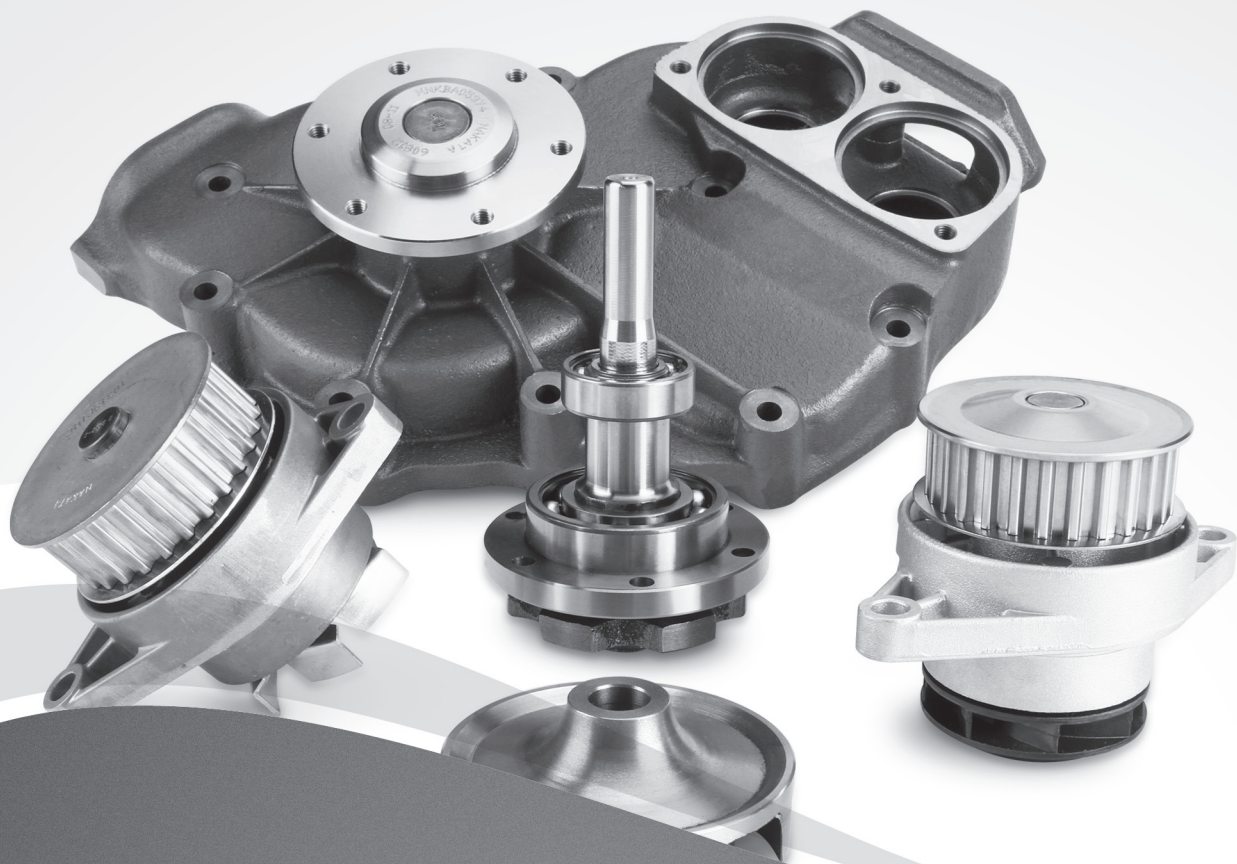

# BOMBAS D'ÁGUA

Bombas de Agua / Water Pumps

***Veículos: Leve e Pesado***  
***Vehículos: Liviano y Pesado***  
***Vehicles: Light and Heavy Duty***

NAKATA	Descrição / Descripción / Description		Páginas / Páginas / Pages
NKBA01767	Bomba de Água + Tampa / Bomba de Agua + Tampa / Water pump + Cover	FIAT Bravo 1.8 E.TORQ 16V 01/11 12/16 / FIAT Dobló 1.8 E.TORQ 16V 01/11 12/16 / FIAT Grand Siena 1.6 E.TORQ 16V 01/13 12/16 / FIAT Idea 1.6 E.TORQ 16V 01/11 12/16 / FIAT Idea 1.8 E.TORQ 16V 01/11 12/16 / FIAT Linea 1.8 E.TORQ 16V 01/11 12/16 / FIAT Palio Novo 1.6 E.TORQ 16V 01/11 12/16 / FIAT Palio Weekend 1.6 E.TORQ 16V 01/11 12/16 / FIAT Palio Weekend 1.8 E.TORQ 16V 01/11 12/16 / FIAT Punto 1.6 E.TORQ 16V 01/11 12/16 / FIAT Punto 1.8 E.TORQ 16V 01/11 12/16 / FIAT Siena 1.6 E.TORQ 16V 01/11 12/16 / FIAT Strada 1.8 E.TORQ 16V 01/11 12/16	
NKBA01769	Bomba de Água / Bomba de Agua / Water pump	FIAT Bravo 1.8 E.TORQ 16V 01/11 12/16 / FIAT Dobló 1.8 E.TORQ 16V 01/11 12/16 / FIAT Grand Siena 1.6 E.TORQ 16V 01/13 12/16 / FIAT Idea 1.6 E.TORQ 16V 01/11 12/16 / FIAT Idea 1.8 E.TORQ 16V 01/11 12/16 / FIAT Linea 1.8 E.TORQ 16V 01/11 12/16 / FIAT Palio Novo 1.6 E.TORQ 16V 01/11 12/16 / FIAT Palio Weekend 1.6 E.TORQ 16V 01/11 12/16 / FIAT Palio Weekend 1.8 E.TORQ 16V 01/11 12/16 / FIAT Punto 1.6 E.TORQ 16V 01/11 12/16 / FIAT Punto 1.8 E.TORQ 16V 01/11 12/16 / FIAT Siena 1.6 E.TORQ 16V 01/11 12/16 / FIAT Strada 1.8 E.TORQ 16V 01/11 12/16	
NKBA01772	Tampa da Bomba de Água / Tampa da Bomba de Água / Water pump Cover	FIAT Bravo 1.8 E.TORQ 16V 01/11 12/16 / FIAT Dobló 1.8 E.TORQ 16V 01/11 12/16 / FIAT Grand Siena 1.6 E.TORQ 16V 01/13 12/16 / FIAT Idea 1.6 E.TORQ 16V 01/11 12/16 / FIAT Idea 1.8 E.TORQ 16V 01/11 12/16 / FIAT Linea 1.8 E.TORQ 16V 01/11 07/16 / FIAT Palio Novo 1.6 E.TORQ 16V 01/11 12/16 / FIAT Palio Weekend 1.6 E.TORQ 16V 01/11 12/16 / FIAT Palio Weekend 1.8 E.TORQ 16V 01/11 12/16 / FIAT Punto 1.6 E.TORQ 16V 01/11 12/16 / FIAT Punto 1.8 E.TORQ 16V 01/11 12/16 / FIAT Siena 1.6 E.TORQ 16V 01/11 12/16 / FIAT Strada 1.8 E.TORQ 16V 01/11 12/16	
NKBA02951	Bomba de Água / Bomba de Agua / Water pump	FORD Ecosport 2.0 Duratec 01/03 12/12 / FORD Focus 2.0 Duratec 01/05 12/08 / FORD Fusion 2.3 Duratec 01/06 12/09 / FORD Fusion 2.5 Duratec 01/09 12/12 / FORD Mondeo 2.0 Duratec 01/01 12/07 / FORD Ranger 2.3 Duratec 01/01 12/07	
NKBA03826	Bomba de Água / Bomba de Agua / Water pump	GM Cruze 1.8 16V ECOTEC 01/12 12/16 / GM Sonic 1.6 16V ECOTEC 01/12 12/14	
NKBA12606	Bomba de Água / Bomba de Agua / Water pump	HONDA Civic 1.7 16v 01/01 12/05	
NKBA17421	Bomba de Água / Bomba de Agua / Water pump	HYUNDAI Santa Fé 2.7 01/01 12/06 / HYUNDAI Tucson 2.7 01/04 12/10 / KIA MOTORS Sportage 2.7 01/04 12/10	

	Página/ Pagina/ Page
---	----------------------------

**Veiculos de Passeio & Pick-ups / Vehiculos de Paseo y Camionetas / Passenger Cars & Light Pick-ups**

AUDI	8
CITROËN	8
DODGE	8
FIAT	8
FORD	13
GENERAL MOTORS	15
HONDA	17
HYUNDAI	18
JEEP	18
KIA MOTORS	18
MERCEDES BENZ	18
MITSUBISHI	18
PEUGEOT	18
RENAULT	19
SEAT	19
TOYOTA	19
TROLLER	19
VOLKSWAGEN	20

**Motor / Motor / Engine**

FORD	21
GENERAL MOTORS	22
M.W.M.	22
MAXION	22
MERCEDES BENZ	22
PERKINS	23
SCANIA	23

**Máquinas Agrícolas & Fora de Estrada / Vehiculos Fuera de Carretera / Off Highway**

AGCO	24
CARBORUNDUM	25
CASE	25
CBT	25
CLARK	25
DYNAPAC	25
FIAT ALLIS	26
HYSTER	26
IDEAL	26
MALTRA	26
MARCOPLAN	26
MASSEY FERGUSON	26
PUTZMEISTER	27

	Página/ Pagina/ Page
--	----------------------------

VALMET	27
VOLVO	28
YALE	28
<b>Caminhões &amp; Ônibus / Camiones y Autobuses / Heavy Trucks &amp; Buses</b>	
AGRALE	29
FORD	29
GENERAL MOTORS	31
IVECO	32
MARCOPOLO	32
MERCEDES BENZ	32
SCANIA	37
VOLARE	38
VOLKSWAGEN - MAN	38
VOLVO	39

## Como utilizar este catálogo

Como usar el catálogo

How to use this catalog

# NAKATA®

Neste catálogo você encontrará todas as aplicações da linha de **Bombas d'água NAKATA**. O catálogo está dividido em três tabelas e um índice por código.

**Aplicação por montadora e veículo:** localizada a partir da página 8 apresenta todas as aplicações de bombas d'água, divididas de acordo com a montadora do veículo.

**Tabela de ilustração:** localizada a partir da página 40, facilita a identificação do produto desejado.

**Tabela de equivalência:** localizada a partir da página 50, mostra os códigos dos produtos que devem ser aplicados no lugar de modelos fornecidos pelas montadoras.

**Índice por código NAKATA:** localizado na página 57, indica as páginas da tabela de aplicação que relacionam o produto.

En este catálogo usted encontrará todas las aplicaciones de la línea de **Bombas d'água NAKATA**. El catálogo está dividido en tres tablas y un índice por código.

**Aplicación por marca y modelo:** esta tabla presenta todas las aplicaciones de bombas d'água, dividida de acuerdo con la ensambladora del vehículo.

**Tabla de ilustraciones:** esta tabla presenta el dibujo de cada producto, para mejor identificación.

**Cruce de referencias:** esta tabla indica los códigos de intercambio con otras marcas de la competencia.

**Índice por código NAKATA:** Señala la ubicación de cada Código en las páginas de la tabla de aplicación correspondiente para cada producto.

In this catalog, you will find all information about **NAKATA Water Pumps**. This catalog is divided in three charts and one index code.

**Application by maker and model:** this section presents all applications about water pumps, divided according to the car maker.

**Illustrations chart:** this section presents the image of each product.

**Cross reference list:** this section presents all competitors cross reference part numbers, divided by competitors.

**Index by NAKATA PN's:** this section presents where you could find **NAKATA** p/n in application by manufactures and model charts.

### Aplicação por Montadora e veículo / Bomba D'Água

Aplicación por marca y modelo / Bomba D'Agua

Application by maker and model / Water Pumps

# NAKATA®

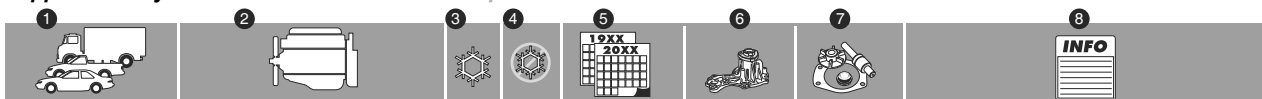

#### Veículos de Passeio & Pick-ups / Vehiculos de Paseo y Camionetas / Passenger Cars & Light Pick-ups

#### AUDI

A3	1.8 4 Cil	●	01/99	12/08	NKBA07633	
	1.8T 20V 4 Cil	●	01/99	12/08	NKBA07633	Motor 150 CV / Motor 150 CV / Engine 150 CV

#### CITROËN

Berlingo	1.1i 8V 4 Cil	●	01/96	12/99	NKBA089018	Polia 20 Dentes
	1.4i 8V 4 Cil	●	01/96	12/99	NKBA089018	Polia 20 Dentes
C 3	1.4 8V 4 Cil	●	01/03	12/16	NKBA08807	
	1.6 16V 4 Cil	●	01/02	12/16	NKBA08808	Polia 19 Dentes
Xsara	1.4i 8V 4 Cil	●	01/97	12/99	NKBA089018	Polia 20 Dentes
	1.6 16V 4 Cil	●	01/05	12/12	NKBA08808	Polia 19 Dentes
	1.6i 8V 4 Cil	●	01/97	12/00	NKBA089013	
Xsara Picasso	1.6 8V 4 Cil	●	01/97	12/00	NKBA089013	

#### DODGE

Dakota	3.9 V6		01/93	12/02	NKBA139003	
	5.2 V8	●	01/97	12/01	NKBA139003	
Ram 1500	3.9 V6	●	01/97	12/97	NKBA139003	
	5.2 V8	●	01/94	06/01	NKBA139003	

# Como utilizar este catálogo

Como usar el catálogo  
How to use this catalog



A estrutura das tabelas é similar, apresentando as seguintes informações:

La estructura de las tablas es similar, presentando las siguientes informaciones:

The structure from the tables is similar, presenting the following information:

- ① Veículo / Vehículo / Vehicle
- ② Motor / Motor / Engine
- ③ Com ar condicionado / Con aire acondicionado / With air conditioned
- ④ Sem ar condicionado / Sin aire acondicionado / Without air conditioned
- ⑤ Ano (Ano Inicial / Ano Final)  
Año (Año Inicial / Año Final)  
Year (Start Year / End Year)
- ⑥ Bomba d'água / Bomba de agua / Water pump
- ⑦ Kit de reparo / Kit de reparo / Repair kit
- ⑧ Observação / Observación / Remark

**Tabela de Ilustrações / Bombas d'Água**  
Tabla de Ilustraciones / Bombas de Agua  
Illustrations chart / Water Pumps

**NAKATA®**

**Bomba d'água**

www.nakata.com.br 41

**Tabela de Equivalência / Bomba D'Água AM**  
Cruce de Referencias / Bomba de Agua AM  
Cross Reference List / Water Pumps AM

**NAKATA®**

BRQSOL	Nakata	INDISA	Nakata	INDISA	Nakata	INDISA	Nakata
310200	NKBA07625	25013	NKBA03135	7000133003	NKBA04325	7000401003	NKBA05366
310300	NKBA07627	25018	NKBA03150	7000133005	NKBA04553	7000401004	NKBA05355
310400	NKBA07628	25021	NKBA03132	7000135004	NKBR04561	7000401008	NKBA05610
310500	NKBA07629	25047	NKBA03149	7000201000	NKBA33582	7000401010	NKBA05372
310600	NKBA07630	25051	NKBA03148	7000201003	NKBA02590	7000401011	NKBA05370
310700	NKBA07631	25059	NKBA03147	7000204000	NKBA02944	7000401012	NKBA05368
340100	NKBA03149	25061	NKBA03152	7000204001	NKBA02942	7000401014	NKBA05373
341200	NKBA03132	25063	NKBA03157	7000204002	NKBA02054	7000401018	NKBA05381
342100	NKBA03135	25073	NKBA04560	7000204003	NKBA02092	7000404000	NKBA05340
343100	NKBA03152	25075	NKBA03128	7000204004	NKBA02946	7000404001	NKBA05376
344100	NKBA03147	25081	NKBR03759	7000204005	NKBA02945	7000452000	NKBA07032
344200	NKBA03146	35001	NKBA01748	7000204007	NKBA02948	7000452001	NKBA07630
350100	NKBA02943	35005	NKBA01753	7000204008	NKBA02950	7000452002	NKBA07031
350200	NKBA02942	35007	NKBA01752	7000205000	NKBA02943	7000452003	NKBA07629
350300	NKBA02947	35009	NKBA01751	7000252000	NKBA03150	7000452006	NKBA07633
352400	NKBA02944	35013	NKBA01757	7000252001	NKBA03149	7000452008	NKBA07033
382000	NKBA01748	40001	NKBR05608	7000252002	NKBA03147	7000454000	NKBA07627
383000	NKBA01753	40002	NKBA05608	7000252003	NKBA03152	7000454001	NKBA07625
380400	NKBA01749	40005	NKBR051358	7000252004	NKBA04560	7000454002	NKBA07628
380500	NKBA01751	40009	NKBA051356	7000252005	NKBA03148	7000454003	NKBA07626
380600	NKBA01752	40015	NKBA051314	7000252007	NKBA03157	7000454005	NKBA07632
380700	NKBA01761	40017	NKBA05313	7000252008	NKBA03162	7000552001	NKBA11981
380800	NKBA01764	40021	NKBA053131	7000252009	NKBA03163	7000552002	NKBA11982
380850	NKBA01763	40027	NKBA05316	7000252010	NKBA03167	7000553000	NKBA11984
		40033	NKBR051315	7000253000	NKBA04560	7000854005	NKBA309016
10003	NKBR06574	40035	NKBR051364	7000254000	NKBA03135	7000904000	NKBA169019
10005	NKBA06576	40041	NKBA05366	7000254003	NKBA03140	7000904001	NKBA169014
10009	NKBA06578	40045	NKBA05355	7000254005	NKBA03128	70009052002	NKBA089018
15001	NKBR04319	40051	NKBR05709	7000254006	NKBA03160	7000952003	NKBA089013
15003	NKBR04392	40055	NKBA05362	7000254008	NKBA03341	SCHADEK	Nakata
15007	NKBR07391	40063	NKBA05610	7000258002	NKBA03132	16001	NKBR051315
15013	NKBR04651	45001	NKBA07627	7000352000	NKBA01751	16002	NKBR05608
15019	NKBR04654	45003	NKBA07625	7000352001	NKBA01757	16003	NKBR05709
15023	NKBR04659	45005	NKBA07628	7000352002	NKBA01761	16004	NKBR051364
15027	NKBA04326	45009	NKBA07626	7000352004	NKBA01756	16006	NKBR051358
15029	NKBA04318	45013	NKBA10732	7000352007	NKBA01770	16007	NKBR051356
15031	NKBA03329	55001	NKBR11983	7000352010	NKBA01763	16008	NKBR051313
15041	NKBA04325	55009	NKBR11985	7000354000	NKBA01748	16009	NKBR06574
15045	NKBA04553	55021	NKBA11982	7000354001	NKBA01753	16010	NKBR06575
15049	NKBA04332	55023	NKBA11984	7000354002	NKBA01752	16011	NKBR04554
15053	NKBA03328	7000104000	NKBA06576	7000354003	NKBA01764	16011	NKBR04559
15055	NKBA04554	7000104001	NKBA06578	7000354004	NKBA01758	16013	NKBR07391
15063	NKBA04331	7000105001	NKBA06579	7000354005	NKBA01760	16014	NKBR04392
20003	NKBA02944	7000105002	NKBA06577	7000354007	NKBA01780	16015	NKBR04561
20007	NKBA02943	7000152000	NKBA04326	7000354009	NKBA01766	16016	NKBR04393
20009	NKBA02942	7000152002	NKBA04332	7000354010	NKBA01749	16020	NKBR051373
20011	NKBA02054	7000152003	NKBA03328	7000400001	NKBA05316	16021	NKBR11985
21003	NKBA33582	7000152004	NKBA04554	7000400005	NKBA05369	16022	NKBR11983
21005	NKBR33478	7000152007	NKBA04333	7000400006	NKBA05367	16025	NKBR121300
21019	NKBA02990	7000153000	NKBA04318	7000401000	NKBA05608	16026	NKBR051372
21035	NKBR02067	7000153001	NKBA03329	7000401001	NKBA05314	16028	NKBR051371

www.nakata.com.br 50

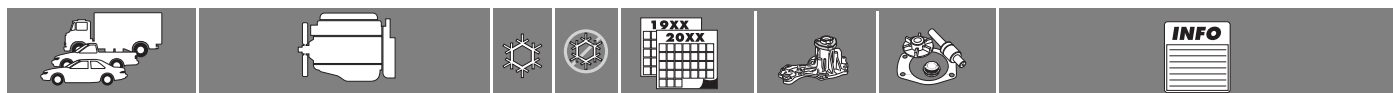

**Veiculos de Passeio & Pick-ups / Vehiculos de Paseo y Camionetas / Passenger Cars & Light Pick-ups**

**AUDI**

A3	1.8 4 Cil	•	01/99	12/08	NKBA07633	
	1.8T 20V 4 Cil	•	01/99	12/08	NKBA07633	Motor 150 CV / Motor 150 CV / Engine 150 CV

**CITROËN**

Berlingo	1.1i 8V 4 Cil	•	01/96	12/99	NKBA089018	Polia 20 Dentes
	1.4i 8V 4 Cil	•	01/96	12/99	NKBA089018	Polia 20 Dentes
C 3	1.4 8V 4 Cil	•	01/03	12/16	NKBA08807	
	1.6 16V 4 Cil	•	01/02	12/16	NKBA08808	Polia 19 Dentes
Xsara	1.4i 8V 4 Cil	•	01/97	12/99	NKBA089018	Polia 20 Dentes
	1.6 16V 4 Cil	•	01/05	12/12	NKBA08808	Polia 19 Dentes
	1.6i 8V 4 Cil	•	01/97	12/00	NKBA089013	
Xsara Picasso	1.6 8V 4 Cil	•	01/97	12/00	NKBA089013	

**DODGE**

Dakota	3.9 V6		01/93	12/02	NKBA139003	
	5.2 V8	•	01/97	12/01	NKBA139003	
Ram 1500	3.9 V6	•	01/97	12/97	NKBA139003	
	5.2 V8	•	01/94	06/01	NKBA139003	
	5.9 V8	•	01/94	06/02	NKBA139003	
Ram 2500	3.9 V6	•	01/97	12/97	NKBA139003	
	5.2 V8	•	01/94	06/01	NKBA139003	
	5.9 V8	•	01/94	06/02	NKBA139003	
Ram 3500	3.9 V6	•	01/97	12/97	NKBA139003	
	5.2 V8	•	01/94	06/01	NKBA139003	
	5.9 V8	•	01/94	06/02	NKBA139003	

**FIAT**

147	1.050 4 Cil	•	01/76	12/84	NKBA01748	Correia Simples / Correa Simple de Cuero / Single Leather strap
	1.050 4 Cil	•	01/76	12/84	NKBA01749	Polia Multi V - Rolamento Reforçado / Polea Multi V - Rodamiento Reforzado / Multi V Pulley - Strong Bearing
	1.3 4 Cil	•	01/76	12/84	NKBA01748	Correia Simples / Correa Simple de Cuero / Single Leather strap
	1.3 4 Cil	•	01/76	12/84	NKBA01749	Polia Multi V - Rolamento Reforçado / Polea Multi V - Rodamiento Reforzado / Multi V Pulley - Strong Bearing
	1.5 4 Cil	•	01/76	12/84	NKBA01748	Correia Simples / Correa Simple de Cuero / Single Leather strap
	1.5 4 Cil	•	01/76	12/84	NKBA01749	Polia Multi V - Rolamento Reforçado / Polea Multi V - Rodamiento Reforzado / Multi V Pulley - Strong Bearing
Brava	1.6 16V 4 Cil	•	01/00	12/06	NKBA01756	Com Polia Multi V / Con Polea Multi V / With Multi V Pulley
Bravo	1.8 E.TORQ 16V 4 Cil		01/11	12/16	NKBA01767	Sistema Melling / Bomba D'água + Tampa da Bomba D'água
	1.8 E.TORQ 16V 4 Cil		01/11	12/16	NKBA01769	Sistema Melling / Bomba D'água
	1.8 E.TORQ 16V 4 Cil		01/11	12/16	NKBA01772	Sistema Melling / Tampa da Bomba D'água
Dobló	1.3 16V Fire 4 Cil	•	01/03	12/08	NKBA01766	
	1.3 8V Fire 4 Cil	•	01/03	12/08	NKBA01766	





**Veiculos de Passeio & Pick-ups / Vehiculos de Paseo y Camionetas / Passenger Cars & Light Pick-ups**

**FIAT**

Dobló	1.4 8V Fire 4 Cil	•	•	01/03	12/16	<b>NKBA01766</b>	
	1.6 16V 4 Cil	•	•	01/00	12/08	<b>NKBA01756</b>	Com Polia Multi V / Con Polea Multi V / With Multi V Pulley
	1.8 8V 4 Cil	•	•	01/03	12/10	<b>NKBA03162</b>	Polia com 19 dentes / Polea con 19 dientes / Pulley with 19 teeth
	1.8 E.TORQ 16V 4 Cil			01/11	12/16	<b>NKBA01767</b>	Sistema Melling / Bomba D'água + Tampa da Bomba D'água
	1.8 E.TORQ 16V 4 Cil			01/11	12/16	<b>NKBA01769</b>	Sistema Melling / Bomba D'água
	1.8 E.TORQ 16V 4 Cil			01/11	12/16	<b>NKBA01772</b>	Sistema Melling / Tampa da Bomba D'água
Ducato	2.5 4 Cil Diesel	•		01/98	12/12	<b>NKBA01780</b>	
	2.8 4 Cil Diesel	•		01/97	12/12	<b>NKBA01780</b>	
Elba	1.050	•	•	01/87	12/93	<b>NKBA01748</b>	Correia Simples / Correa Simple de Cuero / Single Leather strap
	1.050 4 Cil	•	•	01/87	12/93	<b>NKBA01749</b>	Polia Multi V - Rolamento Reforçado / Polea Multi V - Rodamiento Reforzado / Multi V Pulley - Strong Bearing
	1.3	•	•	01/87	12/93	<b>NKBA01748</b>	Correia Simples / Correa Simple de Cuero / Single Leather strap
	1.3 4 Cil	•	•	01/87	12/93	<b>NKBA01749</b>	Polia Multi V - Rolamento Reforçado / Polea Multi V - Rodamiento Reforzado / Multi V Pulley - Strong Bearing
	1.5 4 Cil	•	•	01/94	12/95	<b>NKBA01749</b>	Polia Multi V - Rolamento Reforçado / Polea Multi V - Rodamiento Reforzado / Multi V Pulley - Strong Bearing
	1.5 Argentino 4 Cil		•	01/85	12/89	<b>NKBA01751</b>	Polia com 16mm / Polea com 16mm / Pulley with 16mm
	1.6 4 Cil	•	•	01/94	12/96	<b>NKBA01758</b>	Sem Polia / Sin Polea / Without Pulley
	Fiorino	1.0 8V 4 Cil	•	•	01/85	12/99	<b>NKBA01749</b>
1.050		•	•	01/85	12/90	<b>NKBA01748</b>	Correia Simples / Correa Simple de Cuero / Single Leather strap
1.3		•	•	01/85	12/93	<b>NKBA01748</b>	Correia Simples / Correa Simple de Cuero / Single Leather strap
1.3 4 Cil		•	•	01/85	12/93	<b>NKBA01749</b>	Polia Multi V - Rolamento Reforçado / Polea Multi V - Rodamiento Reforzado / Multi V Pulley - Strong Bearing
1.5 4 Cil		•	•	01/94	12/95	<b>NKBA01749</b>	Polia Multi V - Rolamento Reforçado / Polea Multi V - Rodamiento Reforzado / Multi V Pulley - Strong Bearing
1.5 4 Cil		•	•	01/96	12/99	<b>NKBA01764</b>	Com Flange / Con Flange / With Flange
	1.6 4 Cil	•	•	01/94	12/96	<b>NKBA01758</b>	Sem Polia / Sin Polea / Without Pulley
Grand Siena	1.6 E.TORQ 16V 4 Cil			01/13	12/16	<b>NKBA01767</b>	Sistema Melling / Bomba D'água + Tampa da Bomba D'água
	1.6 E.TORQ 16V 4 Cil			01/13	12/16	<b>NKBA01769</b>	Sistema Melling / Bomba D'água
	1.6 E.TORQ 16V 4 Cil			01/13	12/16	<b>NKBA01772</b>	Sistema Melling / Tampa da Bomba D'água
Idea	1.4 8V 4 Cil	•	•	01/06	12/16	<b>NKBA01766</b>	
	1.6 E.TORQ 16V 4 Cil			01/11	12/16	<b>NKBA01767</b>	Sistema Melling / Bomba D'água + Tampa da Bomba D'água
	1.6 E.TORQ 16V 4 Cil			01/11	12/16	<b>NKBA01769</b>	Sistema Melling / Bomba D'água
	1.6 E.TORQ 16V 4 Cil			01/11	12/16	<b>NKBA01772</b>	Sistema Melling / Tampa da Bomba D'água
	1.8 8V 4 Cil	•	•	01/06	12/10	<b>NKBA03162</b>	Polia com 19 dentes / Polea con 19 dientes / Pulley with 19 teeth

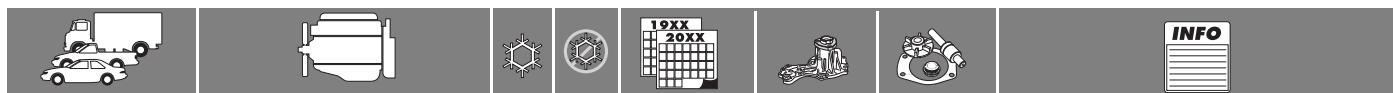

**Veiculos de Passeio & Pick-ups / Vehiculos de Paseo y Camionetas / Passenger Cars & Light Pick-ups**

<b>FIAT</b>								
Idea	1.8 E.TORQ 16V 4 Cil			01/11	12/16	NKBA01767	Sistema Melling / Bomba D'água + Tampa da Bomba D'água	
	1.8 E.TORQ 16V 4 Cil			01/11	12/16	NKBA01769	Sistema Melling / Bomba D'água	
	1.8 E.TORQ 16V 4 Cil			01/11	12/16	NKBA01772	Sistema Melling / Tampa da Bomba D'água	
Linea	1.8 E.TORQ 16V 4 Cil			01/11	12/16	NKBA01767	Sistema Melling / Bomba D'água + Tampa da Bomba D'água	
	1.8 E.TORQ 16V 4 Cil			01/11	12/16	NKBA01769	Sistema Melling / Bomba D'água	
	1.8 E.TORQ 16V 4 Cil			01/11	12/16	NKBA01772	Sistema Melling / Tampa da Bomba D'água	
	1.9 16V 4 Cil	•	•	01/08	12/16	NKBA01756	Com Polia Multi V / Con Polea Multi V / With Multi V Pulley	
Marea	1.6 16V 4 Cil	•	•	01/06	12/08	NKBA01756	Com Polia Multi V / Con Polea Multi V / With Multi V Pulley	
Oggi	1.050 4 Cil			•	01/83	12/93	NKBA01748	Correia Simples / Correa Simple de Cuero / Single Leather strap
	1.050 4 Cil			•	01/83	12/93	NKBA01749	Polia Multi V - Rolamento Reforçado / Polea Multi V - Rodamiento Reforzado / Multi V Pulley - Strong Bearing
	1.3			•	01/83	12/88	NKBA01748	Correia Simples / Correa Simple de Cuero / Single Leather strap
	1.3 4 Cil			•	01/83	12/88	NKBA01749	Polia Multi V - Rolamento Reforçado / Polea Multi V - Rodamiento Reforzado / Multi V Pulley - Strong Bearing
Palio	1.0 16V Fire 4 Cil	•	•	09/00	12/09	NKBA01766		
	1.0 8V 4 Cil	•	•	01/96	08/99	NKBA01764	Com Flange / Con Flange / With Flange	
	1.0 8V 4 Cil	•	•	09/99	08/00	NKBA01763	Com Polia Multi V / Con Polea Multi V / With Multi V Pulley	
	1.0 8V Fire 4 Cil	•	•	09/00	12/16	NKBA01766		
	1.3 16V Fire 4 Cil	•	•	01/00	12/08	NKBA01766		
	1.3 8V Fire 4 Cil	•	•	01/03	12/08	NKBA01766		
	1.4 8V Fire 4 Cil	•	•	12/06	12/16	NKBA01766		
	1.5 8V 4 Cil	•	•	01/96	12/98	NKBA01764	Com Flange / Con Flange / With Flange	
	1.5 8V 4 Cil	•	•	09/99	08/00	NKBA01763	Com Polia Multi V / Con Polea Multi V / With Multi V Pulley	
	1.6 16V 4 Cil	•	•	01/96	12/08	NKBA01756	Com Polia Multi V / Con Polea Multi V / With Multi V Pulley	
	1.6 E.TORQ 16V 4 Cil			01/11	12/16	NKBA01767	Sistema Melling / Bomba D'água + Tampa da Bomba D'água	
	1.6 E.TORQ 16V 4 Cil			01/11	12/16	NKBA01769	Sistema Melling / Bomba D'água	
	1.6 E.TORQ 16V 4 Cil			01/11	12/16	NKBA01772	Sistema Melling / Tampa da Bomba D'água	
1.8 8V 4 Cil	•	•	01/03	12/10	NKBA03162	Polia com 19 dentes / Polea con 19 dientes / Pulley with 19 teeth		
Palio Weekend	1.0 16V Fire 4 Cil	•	•	01/00	12/08	NKBA01766		
	1.0 8V 4 Cil	•	•	01/96	08/99	NKBA01764	Com Flange / Con Flange / With Flange	
	1.3 16V Fire 4 Cil	•	•	01/00	12/08	NKBA01766		
	1.4 8V Fire 4 Cil	•	•	01/05	12/16	NKBA01766		
	1.6 16V 4 Cil	•	•	01/97	12/08	NKBA01756	Com Polia Multi V / Con Polea Multi V / With Multi V Pulley	
	1.6 E.TORQ 16V 4 Cil			01/11	12/16	NKBA01767	Sistema Melling / Bomba D'água + Tampa da Bomba D'água	
	1.6 E.TORQ 16V 4 Cil			01/11	12/16	NKBA01769	Sistema Melling / Bomba D'água	
	1.6 E.TORQ 16V 4 Cil			01/11	12/16	NKBA01772	Sistema Melling / Tampa da Bomba D'água	



**Veiculos de Passeio & Pick-ups / Vehiculos de Paseo y Camionetas / Passenger Cars & Light Pick-ups**

**FIAT**

Palio Weekend	1.8 8V 4 Cil	•	•	01/03	12/10	<b>NKBA03162</b>	Polia com 19 dentes / Polea con 19 dientes / Pulley with 19 teeth
	1.8 E.TORQ 16V 4 Cil			01/11	12/16	<b>NKBA01767</b>	Sistema Melling / Bomba D'água + Tampa da Bomba D'água
	1.8 E.TORQ 16V 4 Cil			01/11	12/16	<b>NKBA01769</b>	Sistema Melling / Bomba D'água
	1.8 E.TORQ 16V 4 Cil			01/11	12/16	<b>NKBA01772</b>	Sistema Melling / Tampa da Bomba D'água
Panorama	1.050 4 Cil	•	•	01/81	12/88	<b>NKBA01748</b>	Correia Simples / Correa Simple de Cuero / Single Leather strap
	1.050 4 Cil	•	•	01/81	12/88	<b>NKBA01749</b>	Polia Multi V - Rolamento Reforçado / Polea Multi V - Rodamiento Reforzado / Multi V Pulley - Strong Bearing
	1.3	•	•	01/81	12/88	<b>NKBA01748</b>	Correia Simples / Correa Simple de Cuero / Single Leather strap
	1.3 4 Cil	•	•	01/81	12/88	<b>NKBA01749</b>	Polia Multi V - Rolamento Reforçado / Polea Multi V - Rodamiento Reforzado / Multi V Pulley - Strong Bearing
Premio	1.3	•	•	01/85	12/88	<b>NKBA01748</b>	Correia Simples / Correa Simple de Cuero / Single Leather strap
	1.3 4 Cil	•	•	01/85	12/88	<b>NKBA01749</b>	Polia Multi V - Rolamento Reforçado / Polea Multi V - Rodamiento Reforzado / Multi V Pulley - Strong Bearing
	1.5 Argentino 4 Cil	•	•	01/85	12/89	<b>NKBA01751</b>	Polia com 16mm / Polea com 16mm / Pulley with 16mm
	1.5 Argentino 4 Cil	•	•	01/87	12/95	<b>NKBA01752</b>	Com Flange rosca M6x1 / Com Flange rosca M6x1 / With Flange Thread M6x1
	1.6 4 Cil	•	•	01/94	12/96	<b>NKBA01758</b>	Sem Polia / Sin Polea / Without Pulley
	1.6 Argentino 4 Cil	•	•	01/87	12/95	<b>NKBA01752</b>	
	1.6 Argentino 4 Cil	•	•	01/90	12/95	<b>NKBA01757</b>	
Punto	1.4 8V Fire 4 Cil	•	•	07/07	12/16	<b>NKBA01766</b>	
	1.6 E.TORQ 16V 4 Cil			01/11	12/16	<b>NKBA01767</b>	Sistema Melling / Bomba D'água + Tampa da Bomba D'água
	1.6 E.TORQ 16V 4 Cil			01/11	12/16	<b>NKBA01769</b>	Sistema Melling / Bomba D'água
	1.6 E.TORQ 16V 4 Cil			01/11	12/16	<b>NKBA01772</b>	Sistema Melling / Tampa da Bomba D'água
	1.8 8V 4 Cil	•	•	07/07	12/16	<b>NKBA03162</b>	
	1.8 E.TORQ 16V 4 Cil			01/11	12/16	<b>NKBA01767</b>	Sistema Melling / Bomba D'água + Tampa da Bomba D'água
	1.8 E.TORQ 16V 4 Cil			01/11	12/16	<b>NKBA01769</b>	Sistema Melling / Bomba D'água
	1.8 E.TORQ 16V 4 Cil			01/11	12/16	<b>NKBA01772</b>	Sistema Melling / Tampa da Bomba D'água
Regatta	4 Cil	•	•	01/83	12/93	<b>NKBA01752</b>	
Ritmo	4 Cil	•	•	01/79	12/89	<b>NKBA01752</b>	
Siena	1.0 16V Fire 4 Cil	•	•	01/02	12/08	<b>NKBA01766</b>	
	1.0 8V Fire 4 Cil	•	•	01/02	12/09	<b>NKBA01766</b>	
	1.3 16V Fire 4 Cil	•	•	01/06	12/08	<b>NKBA01766</b>	
	1.4 8V Fire 4 Cil	•	•	01/06	12/16	<b>NKBA01766</b>	
	1.5 4 Cil	•	•	01/99	12/00	<b>NKBA01763</b>	
	1.6 16V 4 Cil	•	•	01/98	12/08	<b>NKBA01756</b>	Com Polia Multi V / Con Polea Multi V / With Multi V Pulley
	1.6 E.TORQ 16V 4 Cil			01/11	12/16	<b>NKBA01767</b>	Sistema Melling / Bomba D'água + Tampa da Bomba D'água
	1.6 E.TORQ 16V 4 Cil			01/11	12/16	<b>NKBA01769</b>	Sistema Melling / Bomba D'água
	1.6 E.TORQ 16V 4 Cil			01/11	12/16	<b>NKBA01772</b>	Sistema Melling / Tampa da Bomba D'água

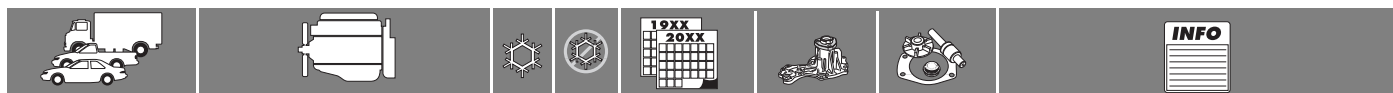

**Veiculos de Passeio & Pick-ups / Vehiculos de Paseo y Camionetas / Passenger Cars & Light Pick-ups**

<b>FIAT</b>							
Siena	1.8 8V 4 Cil	●	●	01/03	12/10	NKBA03162	Polia com 19 dentes / Polea con 19 dientes / Pulley with 19 teeth
Spazio	1.050 4 Cil	●		01/76	12/84	NKBA01748	Correia Simples / Correa Simple de Cuero / Single Leather strap
	1.050 4 Cil	●		01/76	12/84	NKBA01749	Polia Multi V - Rolamento Reforçado / Polea Multi V - Rodamiento Reforzado / Multi V Pulley - Strong Bearing
	1.3	●		01/76	12/84	NKBA01748	Correia Simples / Correa Simple de Cuero / Single Leather strap
	1.3 4 Cil	●		01/76	12/84	NKBA01749	Polia Multi V - Rolamento Reforçado / Polea Multi V - Rodamiento Reforzado / Multi V Pulley - Strong Bearing
Stilo	1.8 16V 4 Cil	●		01/03	12/07	NKBA03163	Polia com 23 dentes / Polea con 23 dientes / Pulley with 23 teeth
	1.8 8V 4 Cil	●		01/02	12/11	NKBA03162	Polia com 19 dentes / Polea con 19 dientes / Pulley with 19 teeth
Strada	1.0 8V 4 Cil	●		01/97	08/99	NKBA01764	Sem Polia Multi V Com Flange / Sin Polea Multi V Con Flange / Without Multi V Pulley With Flange
	1.0 8V 4 Cil	●	●	09/99	08/00	NKBA01763	Com Polia Multi V / Con Polea Multi V / With Multi V Pulley
	1.3 8V 4 Cil	●	●	09/99	08/00	NKBA01763	Com Polia Multi V / Con Polea Multi V / With Multi V Pulley
	1.3 8V Fire 4 Cil	●	●	01/03	12/08	NKBA01766	
	1.4 8V Fire 4 Cil	●	●	01/06	12/16	NKBA01766	
	1.5 8V 4 Cil	●	●	01/97	12/98	NKBA01764	Com Flange / Con Flange / With Flange
	1.6 16V 4 Cil	●	●	01/99	12/08	NKBA01756	Com Polia Multi V / Con Polea Multi V / With Multi V Pulley
	1.8 8V 4 Cil	●	●	01/02	12/10	NKBA03162	Polia com 19 dentes / Polea con 19 dientes / Pulley with 19 teeth
	1.8 E.TORQ 16V 4 Cil			01/11	12/16	NKBA01767	Sistema Melling / Bomba D'água + Tampa da Bomba D'água
	1.8 E.TORQ 16V 4 Cil			01/11	12/16	NKBA01769	Sistema Melling / Bomba D'água
1.8 E.TORQ 16V 4 Cil			01/11	12/16	NKBA01772	Sistema Melling / Tampa da Bomba D'água	
Tipo	1.6 8V 4 Cil	●	●	01/94	12/95	NKBA01761	
Uno	1.0 8V	●	●	01/85	12/94	NKBA01748	Correia Simples / Correa Simple de Cuero / Single Leather strap
	1.0 8V 4 Cil	●	●	01/85	12/01	NKBA01749	Polia Multi V - Rolamento Reforçado / Polea Multi V - Rodamiento Reforzado / Multi V Pulley - Strong Bearing
	1.0 8V Fire 4 Cil	●	●	01/02	12/13	NKBA01766	
	1.3 4 Cil	●	●	01/85	12/93	NKBA01748	Correia Simples / Correa Simple de Cuero / Single Leather strap
	1.3 4 Cil	●	●	01/85	12/93	NKBA01749	Polia Multi V - Rolamento Reforçado / Polea Multi V - Rodamiento Reforzado / Multi V Pulley - Strong Bearing
	1.5 4 Cil	●	●	01/94	12/95	NKBA01749	Polia Multi V - Rolamento Reforçado / Polea Multi V - Rodamiento Reforzado / Multi V Pulley - Strong Bearing
	1.5 4 Cil	●	●	01/96	12/99	NKBA01764	MPI Sem Polia Multi V Com Flange / MPI Sin Polea Multi V Con Flange / MPI Without Multi V Pulley With Flange
	1.5 Argentino 4 Cil	●		01/84	12/95	NKBA01752	Com Flange rosca M6x1 / Com Flange rosca M6x1 / With Flange Thread M6x1

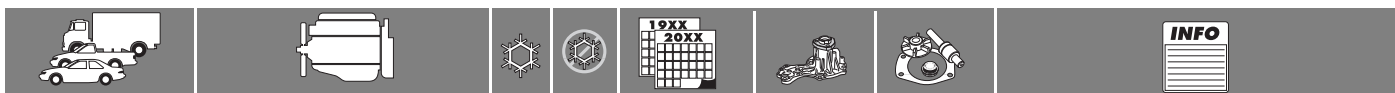

**Veiculos de Passeio & Pick-ups / Vehiculos de Paseo y Camionetas / Passenger Cars & Light Pick-ups**

**FIAT**

Uno	1.5 Argentino 4 Cil	•	01/85	12/89	<b>NKBA01751</b>	Polia com 16mm / Polea com 16mm / Pulley with 16mm
	1.6 4 Cil	•	01/94	12/96	<b>NKBA01758</b>	Sem Polia / Sin Polea / Without Pulley
	1.6 Argentino 4 Cil	•	01/84	12/95	<b>NKBA01752</b>	
	1.6 Argentino 4 Cil	•	01/90	12/95	<b>NKBA01757</b>	
	1.6R 4 Cil	•	01/94	12/96	<b>NKBA01758</b>	Sem Polia / Sin Polea / Without Pulley

**FORD**

Aero Willys	BF 161 6 Cil	•	01/60	12/76	<b>NKBA02054</b>	
Belina	4 Cil	•	01/78	06/83	<b>NKBA02942</b>	Sem Polia Magnética / Sin Polea Magnética / Without Magnetic Pulley
	4 Cil	•	01/89	12/91	<b>NKBA07627</b>	Polia V / Polea V / V Pulley
	4 Cil	•	07/83	12/91	<b>NKBA02943</b>	Com Polia Magnética / Con Polea Magnética / With Magnetic Pulley
Corcel	4 Cil	•	01/78	06/83	<b>NKBA02942</b>	Sem Polia Magnética / Sin Polea Magnética / Without Magnetic Pulley
	4 Cil	•	07/83	12/91	<b>NKBA02943</b>	Com Polia Magnética / Con Polea Magnética / With Magnetic Pulley
Corcel II	4 Cil	•	01/78	06/83	<b>NKBA02942</b>	Sem Polia Magnética / Sin Polea Magnética / Without Magnetic Pulley
	4 Cil	•	07/83	12/91	<b>NKBA02943</b>	Com Polia Magnética / Con Polea Magnética / With Magnetic Pulley
Courier	1.3 Endura 4 Cil	•	01/97	12/99	<b>NKBA02946</b>	
	1.4 16V Zetec Rocan 4 Cil	•	01/97	12/99	<b>NKBA02948</b>	
	1.6 Zetec Rocan 4 Cil	•	01/00	12/14	<b>NKBA02947</b>	
Del Rey	1.6 CHT 4 Cil	•	01/81	06/83	<b>NKBA02942</b>	Sem Polia Magnética / Sin Polea Magnética / Without Magnetic Pulley
	1.6 CHT 4 Cil	•	07/83	12/91	<b>NKBA02943</b>	Com Polia Magnética / Con Polea Magnética / With Magnetic Pulley
	1.8 AP 8V 4 Cil	•	01/89	12/91	<b>NKBA07627</b>	Polia V / Polea V / V Pulley
EcoSport	1.0 SuperCharger 4 Cil	•	01/03	12/08	<b>NKBA02947</b>	
	1.0 Zetec Rocan 4 Cil	•	01/03	12/08	<b>NKBA02947</b>	
	1.6 SIGMA 16V 4 Cil		01/12	12/16	<b>NKBA02952</b>	
	1.6 Zetec Rocan 4 Cil	•	01/03	12/12	<b>NKBA02947</b>	
	2.0 Duratec		01/03	12/12	<b>NKBA02951</b>	
Escort	1.0 CHT 4 Cil	•	01/93	12/95	<b>NKBA02944</b>	
	1.3 4 Cil	•	01/84	12/96	<b>NKBA02944</b>	
	1.6 16V 4 Cil	•	01/96	12/98	<b>NKBA02945</b>	Zetec
	1.6 AP 8V 4 Cil	•	01/89	12/02	<b>NKBA07627</b>	Polia V / Polea V / V Pulley
	1.6 CHT 4 Cil	•	01/83	12/96	<b>NKBA02944</b>	
	1.8 16V 4 Cil	•	01/96	12/98	<b>NKBA02945</b>	Zetec
	1.8 AP 8V 4 Cil	•	01/89	12/02	<b>NKBA07627</b>	Polia V / Polea V / V Pulley
	2.0 AP 8V 4 Cil	•	01/89	12/02	<b>NKBA07627</b>	Polia V / Polea V / V Pulley
F 100		•	01/75	12/83	<b>NKBA02092</b>	
	MWM D229	•	01/80	12/90	<b>NKBA06576</b>	
F 1000	MWM D229	•	01/80	12/90	<b>NKBA06576</b>	
	MWM Sprint	•	01/80	12/90	<b>NKBA06577</b>	Engrenagem 15° / Engranaje 15° / Gear 15°
	MWM TD229 EC	•	01/80	12/90	<b>NKBA06578</b>	NKBR06575

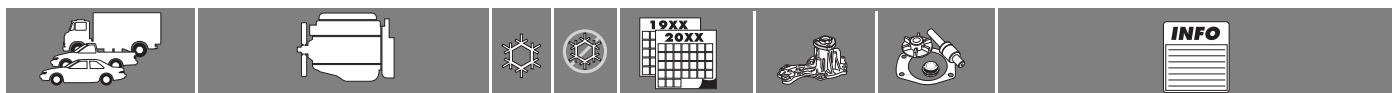

**Veiculos de Passeio & Pick-ups / Vehiculos de Paseo y Camionetas / Passenger Cars & Light Pick-ups**

**FORD**

F 350	4.2 Sprint Turbo 6 Cil Diesel	•	•	01/99	12/06	<b>NKBA06577</b>	Engrenagem 15° / Engranaje 15° / Gear 15°
	MWM D229 Diesel			•	01/80	12/90	
Fiesta	1.0 Endura 4 Cil	•	•	01/96	12/99	<b>NKBA02946</b>	
	1.0 Supercharger 4 Cil			•	01/00	12/08	<b>NKBA02947</b>
	1.0 Supercharger 4 Cil	•		01/00	12/14	<b>NKBA02947</b>	
	1.0 Zetec Rocan 4 Cil	•	•	01/00	12/14	<b>NKBA02947</b>	
	1.3 Endura 4 Cil	•	•	01/96	12/98	<b>NKBA02946</b>	
	1.4 16V Zetec Rocan 4 Cil	•	•	01/96	12/99	<b>NKBA02948</b>	
	1.6 Zetec Rocan 4 Cil	•	•	01/99	12/12	<b>NKBA02947</b>	
Focus	1.6 SIGMA 16V 4 Cil			01/10	12/16	<b>NKBA02952</b>	
	1.6 Zetec Rocan 4 Cil	•		01/03	12/10	<b>NKBA02947</b>	
	1.8 16V Zetec 4 Cil		•	01/98	12/02	<b>NKBA02950</b>	
	2.0 16V Zetec 4 Cil		•	01/98	12/02	<b>NKBA02950</b>	
	2.0 Duratec			01/05	12/08	<b>NKBA02951</b>	
Fusion	2.3 Duratec			01/06	12/09	<b>NKBA02951</b>	
	2.5 Duratec			01/09	12/12	<b>NKBA02951</b>	
Itamaraty	BF 161 6 Cil	•	•	01/60	12/76	<b>NKBA02054</b>	
Jeep	BF 161 6 Cil		•	01/60	12/72	<b>NKBA02054</b>	
Ka	1.0 Endura 4 Cil	•	•	01/97	08/99	<b>NKBA02946</b>	
	1.0 Zetec Rocan 4 Cil	•	•	09/99	12/13	<b>NKBA02947</b>	
	1.3 Endura 4 Cil	•	•	01/97	12/98	<b>NKBA02946</b>	
	1.5 SIGMA 16V 4 Cil			01/14	12/16	<b>NKBA02952</b>	
	1.6 Zetec Rocan 4 Cil	•	•	09/99	12/12	<b>NKBA02947</b>	
Maverick		•	•	01/73	12/79	<b>NKBA02092</b>	
Mondeo	2.0 16V 4 Cil		•	01/98	12/02	<b>NKBA02950</b>	
	2.0 Duratec			01/01	12/07	<b>NKBA02951</b>	
New Fiesta	1.5 SIGMA 16V 4 Cil			01/14	12/16	<b>NKBA02952</b>	
	1.6 SIGMA 16V 4 Cil			01/10	12/16	<b>NKBA02952</b>	
Pampa	1.6 AP 8V 4 Cil	•		01/90	12/97	<b>NKBA07627</b>	Polia V / Polea V / V Pulley
	1.6 CHT 4 Cil	•		01/82	12/97	<b>NKBA02942</b>	Sem Polia Magnética / Sin Polea Magnética / Without Magnetic Pulley
	1.6 CHT 4 Cil	•		07/83	12/97	<b>NKBA02943</b>	Exceto Motor AP e 4x4, com Polia Magnética / Excepto AP y la 4x4, com Polea Magnética / Except engine AP and 4x4, with Magnetic Pulley
	1.8 AP 8V 4 Cil	•		01/90	12/97	<b>NKBA07627</b>	Polia V / Polea V / V Pulley
Ranger	2.3 Duratec			01/01	12/07	<b>NKBA02951</b>	
	2.5 HS MAXION Diesel	•	•	01/98	12/05	<b>NKBA04340</b>	Turbo Diesel / Turbo Diesel / Diesel Turbo
	2.8 HS MAXION Diesel	•	•	01/98	12/05	<b>NKBA04340</b>	Turbo Diesel / Turbo Diesel / Diesel Turbo
Royale	1.8 AP 8V 4 Cil	•	•	01/91	12/96	<b>NKBA07627</b>	Polia V / Polea V / V Pulley
	1.8 AP 8V 4 Cil	•	•	01/95	12/96	<b>NKBA07628</b>	Polia Multi V / Polea Multi V / Multi V Pulley
	2.0 AP 8V 4 Cil	•	•	01/91	12/96	<b>NKBA07627</b>	Polia V / Polea V / V Pulley
	2.0 AP 8V 4 Cil	•	•	01/95	12/96	<b>NKBA07628</b>	Polia Multi V / Polea Multi V / Multi V Pulley
Rural			•	01/75	12/83	<b>NKBA02092</b>	
	BF 161 6 Cil		•	01/70	12/76	<b>NKBA02054</b>	
Verona	1.6 CHT 4 Cil	•	•	01/90	12/95	<b>NKBA02944</b>	



**Veiculos de Passeio & Pick-ups / Vehiculos de Paseo y Camionetas / Passenger Cars & Light Pick-ups**

**FORD**

Verona	1.8 AP 8V 4 Cil	•	•	01/90	12/95	<b>NKBA07627</b>		Polia V / Polea V / V Pulley
	2.0 AP 8V 4 Cil	•	•	01/90	12/95	<b>NKBA07627</b>		Polia V / Polea V / V Pulley
Versailles	1.8 AP 8V 4 Cil	•	•	01/91	12/96	<b>NKBA07627</b>		Polia V / Polea V / V Pulley
	1.8 AP 8V 4 Cil	•	•	01/95	12/96	<b>NKBA07628</b>		Polia Multi V / Polea Multi V / Multi V Pulley
	2.0 AP 8V 4 Cil	•	•	01/91	12/96	<b>NKBA07627</b>		Polia V / Polea V / V Pulley
	2.0 AP 8V 4 Cil	•	•	01/95	12/96	<b>NKBA07628</b>		Polia Multi V / Polea Multi V / Multi V Pulley

**GENERAL MOTORS**

A/C/D 10	151	•	•	01/76	12/84	<b>NKBA03135</b>		
	250 6 Cil	•	•	01/81	12/92	<b>NKBA03135</b>		
	261 6 Cil	•	•	01/64	12/84	<b>NKBA03128</b>	NKBR03759	
	Perkins 4236 4 Cil Diesel	•	•	01/79	12/84	<b>NKBA03328</b>	NKBR07391	Sem Polia / Sin Polea / Without Pulley
A/C/D 14	Perkins 4236 4 Cil Diesel	•	•	01/79	12/84	<b>NKBA03328</b>	NKBR07391	Sem Polia / Sin Polea / Without Pulley
A/C/D 20	250 6 Cil	•	•	01/81	12/92	<b>NKBA03135</b>		
	4.1 6 Cil	•	•	01/96	12/97	<b>NKBA03160</b>		
	MAXION Diesel	•	•	01/80	12/90	<b>NKBA04340</b>		
	Maxion S4/S4T Diesel	•	•	01/92	12/02	<b>NKBA04333</b>	NKBR04393	Sem Polia / Sin Polea / Without Pulley
	Perkins Q20B 4 Cil Diesel	•	•	01/84	12/92	<b>NKBA04332</b>	NKBR07391	Sem Polia / Sin Polea / Without Pulley
Agile	1.4 8V VHC 4 Cil	•	•	01/10	12/14	<b>NKBA03167</b>		
Astra	1.8 8V 4 Cil	•	•	01/98	12/12	<b>NKBA03152</b>		Polia com 25 dentes / Polea con 25 dientes / Pulley with 25 teeth
	2.0 16V 4 Cil	•	•	01/98	12/06	<b>NKBA03157</b>		Polia com 25 dentes / Polea con 25 dientes / Pulley with 25 teeth
	2.0 8V 4 Cil	•	•	01/98	12/11	<b>NKBA03152</b>		Polia com 25 dentes / Polea con 25 dientes / Pulley with 25 teeth
Blazer	2.2 EFI 4 Cil	•	•	01/96	12/06	<b>NKBA03152</b>		Polia com 25 dentes / Polea con 25 dientes / Pulley with 25 teeth
	2.4 MPFI 4 Cil	•	•	01/01	12/11	<b>NKBA03152</b>		Polia com 25 dentes / Polea con 25 dientes / Pulley with 25 teeth
	2.5 HS MAXION Diesel	•	•	01/96	12/02	<b>NKBA04340</b>		Turbo Diesel / Turbo Diesel / Diesel Turbo
	2.8 HS MAXION Diesel	•	•	01/97	12/02	<b>NKBA04340</b>		
	4.3 MPFI V6	•	•	01/96	12/06	<b>NKBA03341</b>		
	MWM 4.07 TCA 4 Cil Diesel	•	•	01/03	06/08	<b>NKBA06575</b>		Engrenagem 3° / Engranaje 3° / Gear 3°
	MWM Sprint 2.8 4T Diesel	•	•	01/96	12/02	<b>NKBA04340</b>		Turbo Diesel / Turbo Diesel / Diesel Turbo
Bonanza	Maxion S4 Diesel	•	•	01/92	12/96	<b>NKBA04333</b>	NKBR04393	Sem Polia / Sin Polea / Without Pulley
	Maxion S4T Diesel	•	•	01/92	12/96	<b>NKBA04333</b>	NKBR04393	Sem Polia / Sin Polea / Without Pulley
Caravan GM	4 Cil	•	•	01/69	12/92	<b>NKBA03135</b>		Sem Polia Eletromagnética / Sin Polea Electromagnética / Without Electromagnetic Pulley
Celta	1.0 8V MPFI 4 Cil	•	•	01/00	12/08	<b>NKBA03147</b>		Polia com 19 dentes Exceto VHC / Polea con 19 dientes Excepto VHC / Pulley with 19 teeth Except VHC
	1.0 8V VHC 4 Cil	•	•	01/00	12/15	<b>NKBA03167</b>		
	1.4 8V VHC 4 Cil	•	•	01/02	12/14	<b>NKBA03167</b>		
Chevette	4 Cil			01/81	12/93	<b>NKBA03132</b>		
Cobalt	1.4 8V Econoflex 4 Cil	•	•	01/12	12/16	<b>NKBA03167</b>		
	1.8 8V Econoflex 4 Cil	•	•	01/12	12/16	<b>NKBA03162</b>		Polia com 19 dentes / Polea con 19 dientes / Pulley with 19 teeth

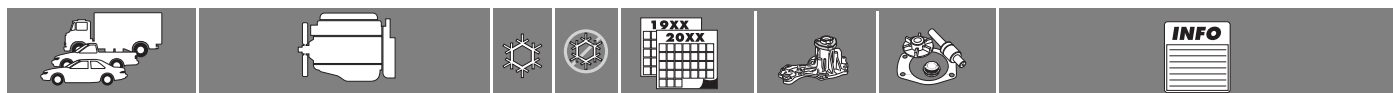

**Veiculos de Passeio & Pick-ups / Vehiculos de Paseo y Camionetas / Passenger Cars & Light Pick-ups**

**GENERAL MOTORS**

Corsa	1.0 16V 4 Cil	•	•	01/99	12/05	<b>NKBA03148</b>	Polia com 23 dentes / Polea con 23 dientes / Pulley with 23 teeth
	1.0 8V 4 Cil	•	•	01/94	12/01	<b>NKBA03147</b>	Polia com 19 dentes / Polea con 19 dientes / Pulley with 19 teeth
	1.0 8V VHC 4 Cil	•	•	01/02	12/12	<b>NKBA03167</b>	Polia com 19 dentes / Polea con 19 dientes / Pulley with 19 teeth
	1.4 8V 4 Cil	•	•	01/94	12/97	<b>NKBA03147</b>	Polia com 19 dentes / Polea con 19 dientes / Pulley with 19 teeth
	1.4 8V VHC 4 Cil	•	•	01/07	12/12	<b>NKBA03167</b>	Polia com 19 dentes / Polea con 19 dientes / Pulley with 19 teeth
	1.6 16V 4 Cil	•	•	01/99	12/05	<b>NKBA03148</b>	Polia com 23 dentes / Polea con 23 dientes / Pulley with 23 teeth
	1.6 8V 4 Cil	•	•	01/94	12/05	<b>NKBA03147</b>	Polia com 19 dentes / Polea con 19 dientes / Pulley with 19 teeth
	1.8 8V 4 Cil	•	•	01/02	12/12	<b>NKBA03162</b>	Polia com 19 dentes / Polea con 19 dientes / Pulley with 19 teeth
Corsa Classic	1.0 8V VHC 4 Cil	•	•	01/03	12/16	<b>NKBA03167</b>	
Cruze	1.8 16V ECOTEC			01/12	12/16	<b>NKBA03826</b>	
Grand Blazer	4.1 6 Cil	•	•	01/97	12/99	<b>NKBA03160</b>	
	4.2 Sprint Turbo 6 Cil Diesel	•	•	01/99	12/06	<b>NKBA06577</b>	Engrenagem 15° / Engranaje 15° / Gear 15°
Ipanema	4 Cil	•	•	01/89	12/95	<b>NKBA03149</b>	Polia com 21 dentes / Polea con 21 dientes / Pulley with 21 teeth
	4 Cil	•	•	01/96	12/98	<b>NKBA03152</b>	Polia com 25 dentes / Polea con 25 dientes / Pulley with 25 teeth
Kadett	4 Cil	•	•	01/89	12/95	<b>NKBA03149</b>	Polia com 21 dentes / Polea con 21 dientes / Pulley with 21 teeth
	4 Cil	•	•	01/96	12/98	<b>NKBA03152</b>	Polia com 25 dentes / Polea con 25 dientes / Pulley with 25 teeth
Meriva	1.4 8V 4 Cil	•		01/06	12/14	<b>NKBA03167</b>	Polia com 19 dentes / Polea con 19 dientes / Pulley with 19 teeth
	1.8 16V 4 Cil	•		01/03	12/07	<b>NKBA03163</b>	Polia com 23 dentes / Polea con 23 dientes / Pulley with 23 teeth
	1.8 8V 4 Cil	•		01/03	12/12	<b>NKBA03162</b>	Polia com 19 dentes / Polea con 19 dientes / Pulley with 19 teeth
Montana	1.4 8V 4 Cil	•	•	01/04	12/16	<b>NKBA03167</b>	Polia com 19 dentes / Polea con 19 dientes / Pulley with 19 teeth
	1.8 8V 4 Cil	•	•	01/04	12/11	<b>NKBA03162</b>	Polia com 19 dentes / Polea con 19 dientes / Pulley with 19 teeth
Monza	4 Cil	•	•	01/82	12/95	<b>NKBA03149</b>	Polia com 21 dentes / Polea con 21 dientes / Pulley with 21 teeth
	4 Cil	•	•	01/87	12/88	<b>NKBA03150</b>	Com Chapa de Cobertura / Con Plato de Cubierta / With Covering Plate
Omega	2.0 4 Cil	•	•	01/93	12/98	<b>NKBA03152</b>	Polia com 25 dentes / Polea con 25 dientes / Pulley with 25 teeth
	2.2 4 Cil	•	•	01/93	12/98	<b>NKBA03152</b>	Polia com 25 dentes / Polea con 25 dientes / Pulley with 25 teeth
	4.1 6 Cil	•	•	01/95	12/98	<b>NKBA03160</b>	
Onix	1.0 SPE/4 4 Cil			01/13	12/16	<b>NKBA03167</b>	
	1.4 SPE/4 4 Cil			01/13	12/16	<b>NKBA03167</b>	
Opala	4 Cil	•		01/69	12/92	<b>NKBA03135</b>	Sem Polia Eletromagnética / Sin Polea Electromagnética / Without Electromagnetic Pulley





**Veiculos de Passeio & Pick-ups / Vehiculos de Paseo y Camionetas / Passenger Cars & Light Pick-ups**

**GENERAL MOTORS**

Opala	4 Cil	• •	01/85	12/92	<b>NKBA03140</b>	
Prisma	1.0 8V VHC 4 Cil	• •	01/07	12/13	<b>NKBA03167</b>	
	1.4 8V VHC 4 Cil	• •	01/07	12/13	<b>NKBA03167</b>	
	1.4 SPE/4 4 Cil	• •	01/14	12/16	<b>NKBA03167</b>	
S10	2.2 EFI 4 Cil	• •	01/96	12/11	<b>NKBA03152</b>	Polia com 25 dentes / Polea con 25 dientes / Pulley with 25 teeth
	2.4 MPFI 4 Cil	• •	01/01	12/11	<b>NKBA03152</b>	Polia com 25 dentes / Polea con 25 dientes / Pulley with 25 teeth
	2.5 HS MAXION Diesel	• •	01/96	12/04	<b>NKBA04340</b>	Turbo Diesel / Turbo Diesel / Diesel Turbo
	2.8 HS MAXION Diesel	• •	01/96	12/04	<b>NKBA04340</b>	Turbo Diesel / Turbo Diesel / Diesel Turbo
	4.3 V6	•	01/96	12/06	<b>NKBA03341</b>	Motor Nacional
	MWM 4.07 TCA 4 Cil Diesel	•	01/03	06/08	<b>NKBA06575</b>	Engrenagem 3° / Engranaje 3° / Gear 3°
	4.3 V6	• •	01/97	12/99	<b>NKBA03160</b>	
Silverado	4.1 6 Cil Diesel	• •	01/97	12/99	<b>NKBA04333</b>	NKBR04393
	4.2 Sprint Turbo 6 Cil Diesel	• •	01/99	12/01	<b>NKBA06577</b>	Engrenagem 15° / Engranaje 15° / Gear 15°
Sonic	1.6 16V ECOTEC		01/12	12/14	<b>NKBA03826</b>	
Spin	1.8 8V Econoflex 4 Cil	• •	01/13	12/16	<b>NKBA03162</b>	Polia com 19 dentes / Polea con 19 dientes / Pulley with 19 teeth
Suprema	2.0 4 Cil	• •	01/93	12/96	<b>NKBA03152</b>	Polia com 25 dentes / Polea con 25 dientes / Pulley with 25 teeth
	2.2 4 Cil	• •	01/93	12/96	<b>NKBA03152</b>	Polia com 25 dentes / Polea con 25 dientes / Pulley with 25 teeth
	4.1 6 Cil	• •	01/94	12/98	<b>NKBA03160</b>	
Vectra	2.0 16V 4 Cil	• •	01/94	12/06	<b>NKBA03157</b>	Polia com 25 dentes / Polea con 25 dientes / Pulley with 25 teeth
	2.0 8V 4 Cil	• •	01/94	12/11	<b>NKBA03152</b>	Polia com 25 dentes / Polea con 25 dientes / Pulley with 25 teeth
	2.2 16V 4 Cil	• •	01/97	12/06	<b>NKBA03157</b>	Polia com 25 dentes / Polea con 25 dientes / Pulley with 25 teeth
	2.2 8V 4 Cil	• •	01/97	12/06	<b>NKBA03152</b>	Polia com 25 dentes / Polea con 25 dientes / Pulley with 25 teeth
	2.4 16V 4 Cil	• •	09/05	12/10	<b>NKBA03157</b>	Polia com 25 dentes / Polea con 25 dientes / Pulley with 25 teeth
Veraneio	151 4 Cil	• •	01/76	12/84	<b>NKBA03135</b>	
	250 6 Cil	• •	01/81	12/92	<b>NKBA03135</b>	
	261 6 Cil	• •	01/64	12/84	<b>NKBA03128</b>	NKBR03759
	Maxion S4/S4T 4 Cil Diesel	• •	01/92	12/97	<b>NKBA04333</b>	NKBR04393 Sem Polia / Sin Polea / Without Pulley
Zafira	2.0 16V 4 Cil	•	01/01	12/08	<b>NKBA03157</b>	Polia com 25 dentes / Polea con 25 dientes / Pulley with 25 teeth
	2.0 8V 4 Cil	•	01/01	12/12	<b>NKBA03152</b>	Polia com 25 dentes / Polea con 25 dientes / Pulley with 25 teeth

**HONDA**

Civic	1.7 16v		01/01	12/05	<b>NKBA12606</b>	
Fit	1.4 8V 4 Cil	•	01/04	12/08	<b>NKBA12604</b>	
	1.5 16V 4 Cil	•	01/04	12/08	<b>NKBA12604</b>	
New Civic	1.8 16V 4 Cil	•	01/06	12/12	<b>NKBA12605</b>	

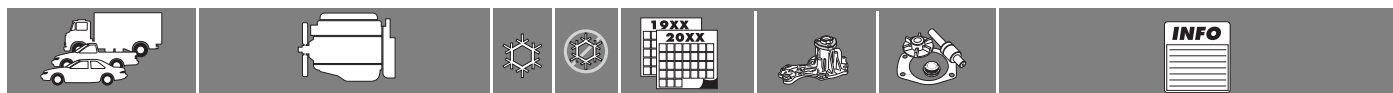

**Veiculos de Passeio & Pick-ups / Vehiculos de Paseo y Camionetas / Passenger Cars & Light Pick-ups**

**HYUNDAI**

H100	4 Cil	•	01/94	12/97	NKBA179004
I30	2.0 16V 4 Cil	•	01/05	12/14	NKBA17420
Santa Fé	2.7		01/01	12/06	NKBA17421
Tucson	2.0 16V 4 Cil	•	01/09	12/16	NKBA17420
	2.7		01/04	12/10	NKBA17421

**JEEP**

Cherokee	4.0 6 Cil	•	01/92	12/01	NKBA139012
Grand Cherokee	5.2 V8	•	01/93	12/00	NKBA139003
	5.9 V8 6 Cil Diesel	•	01/97	12/97	NKBA139003

**KIA MOTORS**

Besta	2.7L 4 Cil Diesel	•	01/98	12/00	NKBA189017	12/16 Lugares
Cerato	2.0 16V 4 Cil	•	01/06	12/12	NKBA17420	
Sportage	2.0 16V 4 Cil	•	01/08	12/12	NKBA17420	
	2.7		01/04	12/10	NKBA17421	

**MERCEDES BENZ**

Sprinter	Maxion HSD 4 Cil Diesel	•	01/97	12/02	NKBA04340
	OM 611LA 4 Cil Diesel	•	01/02	12/11	NKBA05376

**MITSUBISHI**

Galant	2.0 16V	•	01/94	12/99	NKBA309002
	2.3 16V	•	01/94	12/99	NKBA309002
L 200	2.5L 4 Cil	•	01/87	12/95	NKBA179004
L 300	2.5L 4 Cil	•	01/87	12/95	NKBA179004

**PEUGEOT**

106	1.1i 8V 4 Cil	•	01/92	12/98	NKBA089018	Polia 20 Dentes
	1.4i 8V 4 Cil	•	01/91	12/98	NKBA089013	
	1.4i 8V 4 Cil	•	01/92	12/98	NKBA089018	Polia 20 Dentes
	1.6i 8V 4 Cil	•	01/91	12/98	NKBA089013	
205	1.1 8V 4 Cil	•	01/88	12/92	NKBA089018	Polia 20 Dentes
	1.3 8V 4 Cil	•	01/88	12/92	NKBA089018	Polia 20 Dentes
	1.4 8V 4 Cil	•	01/88	12/92	NKBA089018	Polia 20 Dentes
	1.4i 8V 4 Cil	•	01/92	12/96	NKBA089013	
206	1.0 16V 4 Cil	•	01/01	12/10	NKBA09800	
	1.4 8V 4 Cil	•	01/04	12/08	NKBA08807	
	1.6 16V 4 Cil	•	01/01	12/08	NKBA08808	Polia 19 Dentes
	1.6i 8V 4 Cil	•	01/98	12/00	NKBA089013	
207	1.4 8V 4 Cil	•	01/09	12/13	NKBA08807	
	1.6 16V 4 Cil	•	01/09	12/13	NKBA08808	Polia 19 Dentes
306	1.6i 8V 4 Cil	•	01/93	12/96	NKBA089013	
307	1.6 16V 4 Cil	•	01/01	12/11	NKBA08808	Polia 19 Dentes
308	1.6 16V 4 Cil	•	01/12	12/16	NKBA08808	Polia 19 Dentes



**Veiculos de Passeio & Pick-ups / Vehiculos de Paseo y Camionetas / Passenger Cars & Light Pick-ups**

**RENAULT**

Clio	1.0 16V 4 Cil	• •	01/01	12/16	NKBA09800	
	1.0 8V 4 Cil	• •	01/01	12/08	NKBA09805	
	1.6 16V 4 Cil	• •	01/96	12/11	NKBA09820	
	1.6 8V 4 Cil	• •	01/96	12/11	NKBA09815	
Clio Sedan	1.6 16V 4 Cil	• •	01/01	12/11	NKBA09820	
Duster	1.6 16V Hi-Flex 4 Cil	• •	01/12	12/16	NKBA09820	
Kangoo	1.6 16V 4 Cil	• •	01/07	06/12	NKBA09820	
Logan	1.0 16V 4 Cil	• •	01/08	12/16	NKBA09800	
	1.6 16V 4 Cil	• •	01/08	12/13	NKBA09820	
	1.6 8V Hi-Flex 4 Cil	• •	01/08	12/13	NKBA09815	
Megane	1.6 16V 4 Cil	• •	01/06	12/11	NKBA09820	
	1.6 8V 4 Cil	• •	01/05	12/11	NKBA09815	
Sandero	1.0 16V Hi-Flex 4 Cil	• •	01/08	12/16	NKBA09800	
	1.6 16V 4 Cil	• •	01/08	12/16	NKBA09820	
	1.6 8V Hi-Flex 4 Cil	• •	01/08	12/16	NKBA09815	
Scénic	1.6 16V 4 Cil	• •	01/05	12/12	NKBA09820	
	2.0 8V 4 Cil	• •	01/97	12/02	NKBA09813	
Symbol	1.6 16V 4 Cil	• •	01/10	12/16	NKBA09820	
	1.6 8V Hi-Flex 4 Cil	• •	01/10	12/16	NKBA09815	

**SEAT**

Cordoba	1.0 8V 4 Cil	• •	01/97	01/05	NKBA07630	
	1.4 8V 4 Cil	• •	01/97	01/05	NKBA07630	
Ibiza	1.0 8V 4 Cil	• •	01/95	12/05	NKBA07630	
	1.4 8V 4 Cil	• •	01/95	12/05	NKBA07630	
Inca	1.0 8V 4 Cil	• •	01/95	12/05	NKBA07630	
	1.4 8V 4 Cil	• •	01/95	12/05	NKBA07630	

**TOYOTA**

Bandeirantes	OM 314 4 Cil Diesel	•	01/73	12/83	NKBA05608	NKBR05608
Carina	1.8 16V 4 Cil	•	01/95	12/01	NKBA169019	
Celica	1.8 16V 4 Cil	•	01/95	12/01	NKBA169019	
Corolla	1.6 16V 4 Cil	•	01/02	12/08	NKBA16703	
	1.6L 16V 4 Cil	•	01/92	12/01	NKBA169009	
	1.8 16V 4 Cil	•	01/95	12/01	NKBA169019	
	1.8 16V 4 Cil	•	01/02	12/08	NKBA16703	
Hilux	2.8 Turbo Argentino Diesel		01/93	12/98	NKBA169014	
OJ50	OM 364 4 Cil	•	01/80	12/90	NKBA05610	NKBR05709
	OM 364 4 Cil Diesel	•	01/89	12/94	NKBA05609	Exceto motor eletrônico
	OM 364A 4 Cil	•	01/80	12/90	NKBA05610	NKBR05709
	OM 364A 4 Cil Diesel	•	01/89	12/94	NKBA05609	Com rolamento reforçado

**TROLLER**

Troller	MWM 4.07 TCA 4 Cil Diesel	•	01/03	12/14	NKBA06575	Engrenagem 3° / Engranaje 3° / Gear 3°
---------	---------------------------	---	-------	-------	-----------	--

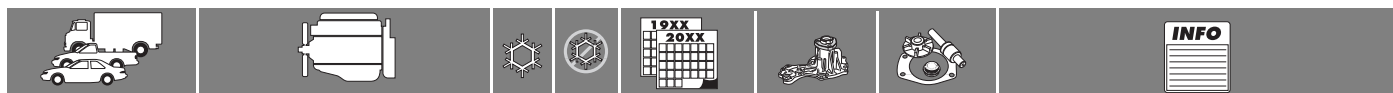

**Veiculos de Passeio & Pick-ups / Vehiculos de Paseo y Camionetas / Passenger Cars & Light Pick-ups**

**VOLKSWAGEN**

Apollo	1.8 4 Cil	•	•	01/90	12/92	<b>NKBA07627</b>	Polia V / Polea V / V Pulley
Bora	2.0 8V 4 Cil	•	•	01/00	12/11	<b>NKBA07633</b>	
CrossFox	1.6 8V (EA111) 4 Cil	•	•	01/05	12/16	<b>NKBA07630</b>	
Fox	1.0 8V (EA111) 4 Cil	•	•	01/04	06/14	<b>NKBA07630</b>	
	1.6 8V (EA111) 4 Cil	•	•	01/04	06/14	<b>NKBA07630</b>	
Gol	1.0 16V (EA111) 4 Cil	•	•	01/97	06/12	<b>NKBA07629</b>	Exceto modelo "Power" / Excepto el modelo "Power" / Except model "Power"
	1.0 8V (EA111) 4 Cil	•	•	10/08	12/16	<b>NKBA07630</b>	
	1.0 8V Power (EA111) 4 Cil	•	•	01/01	06/14	<b>NKBA07636</b>	
	1.0 AE 4 Cil	•	•	01/93	12/95	<b>NKBA02944</b>	
	1.6 4 Cil	•	•	01/95	12/09	<b>NKBA07628</b>	Polia Multi V / Polea Multi V / Multi V Pulley
	1.6 4 Cil	•	•	07/95	12/09	<b>NKBA07627</b>	Polia V / Polea V / V Pulley
	1.6 8V (EA111) 4 Cil	•	•	10/08	12/16	<b>NKBA07630</b>	
	1.6 8V Power (EA111) 4 Cil	•	•	01/01	06/14	<b>NKBA07636</b>	
	1.6 AE 4 Cil	•	•	11/89	12/93	<b>NKBA02944</b>	
	1.6 AP 8V 4 Cil	•	•	01/83	06/85	<b>NKBA07627</b>	
	1.8 4 Cil	•	•	01/95	12/09	<b>NKBA07628</b>	Polia Multi V / Polea Multi V / Multi V Pulley
	1.8 AP 8V 4 Cil	•	•	01/84	12/09	<b>NKBA07627</b>	Polia V / Polea V / V Pulley
	2.0 4 Cil	•	•	01/95	12/09	<b>NKBA07628</b>	Polia Multi V / Polea Multi V / Multi V Pulley
	2.0 AP 8V 4 Cil	•	•	01/84	12/09	<b>NKBA07627</b>	Polia V / Polea V / V Pulley
	Mi 1000 8V (EA111) 4 Cil	•	•	01/97	06/03	<b>NKBA07630</b>	
Golf	1.6 4 Cil	•	•	01/99	12/14	<b>NKBA07633</b>	
	1.6 8V (EA111) 4 Cil	•	•	01/03	12/14	<b>NKBA07630</b>	
	1.8 8V 4 Cil	•	•	01/94	12/98	<b>NKBA07627</b>	Polia V / Polea V / V Pulley
	1.8T 20V 4 Cil	•	•	01/99	12/02	<b>NKBA07633</b>	
	2.0 8V 4 Cil	•	•	01/94	12/98	<b>NKBA07627</b>	Polia V / Polea V / V Pulley
	2.0 8V 4 Cil	•	•	01/99	12/14	<b>NKBA07633</b>	
Kombi	1.4 8V (EA111) 4 Cil	•	•	01/06	12/13	<b>NKBA07640</b>	
	1.4 8V 4 Cil	•	•	01/06	12/13	<b>NKBA07640</b>	
	1.6 4 Cil Diesel	•	•	01/82	12/86	<b>NKBA07626</b>	
Logus	1.6 AE 4 Cil	•	•	01/93	12/95	<b>NKBA02944</b>	
	1.8 4 Cil	•	•	01/93	12/95	<b>NKBA07627</b>	Polia V / Polea V / V Pulley
	2.0 4 Cil	•	•	01/93	12/95	<b>NKBA07627</b>	Polia V / Polea V / V Pulley
New Beetle	2.0 8V 4 Cil	•	•	01/99	12/14	<b>NKBA07633</b>	
Parati	1.0 (AT e EA111) 16V 4 Cil	•	•	01/00	12/09	<b>NKBA07629</b>	Exceto modelo "Power" / Excepto el modelo "Power" / Except model "Power"
	1.0 (AT e EA111) 8V 4 Cil	•	•	01/97	12/09	<b>NKBA07630</b>	Exceto modelo "Power" / Excepto el modelo "Power" / Except model "Power"
	1.0 8V Power (EA111) 4 Cil	•	•	01/01	12/07	<b>NKBA07636</b>	
	1.6 8V Power (EA111) 4 Cil	•	•	01/01	12/09	<b>NKBA07636</b>	
	1.6 AE 4 Cil	•	•	11/89	12/09	<b>NKBA02944</b>	
	1.6 AP 8V 4 Cil	•	•	01/83	06/85	<b>NKBA07627</b>	
	1.6 AP 8V 4 Cil	•	•	01/95	12/09	<b>NKBA07628</b>	Polia Multi V / Polea Multi V / Multi V Pulley
	1.6 AP 8V 4 Cil	•	•	07/95	12/09	<b>NKBA07627</b>	Polia V / Polea V / V Pulley
	1.8 AP 8V 4 Cil	•	•	01/84	12/09	<b>NKBA07627</b>	Polia V / Polea V / V Pulley
	1.8 AP 8V 4 Cil	•	•	01/95	12/09	<b>NKBA07628</b>	Polia Multi V / Polea Multi V / Multi V Pulley

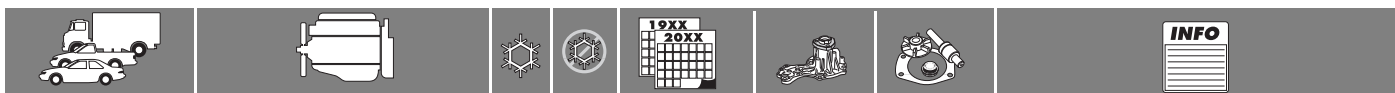

**Veiculos de Passeio & Pick-ups / Vehiculos de Paseo y Camionetas / Passenger Cars & Light Pick-ups**

**VOLKSWAGEN**

Parati	2.0 AP 8V 4 Cil	• •	01/84	12/09	<b>NKBA07627</b>	Polia V / Polea V / V Pulley
	2.0 AP 8V 4 Cil	• •	01/95	12/09	<b>NKBA07628</b>	Polia Multi V / Polea Multi V / Multi V Pulley
Passat	1.5 4 Cil	•	01/74	12/89	<b>NKBA07625</b>	
	1.6 4 Cil	•	07/78	12/88	<b>NKBA07627</b>	Polia V / Polea V / V Pulley
	1.8 4 Cil	• •	01/84	12/88	<b>NKBA07627</b>	Polia V / Polea V / V Pulley
	2.0 4 Cil	•	01/01	12/02	<b>NKBA07633</b>	
Pointer	1.8 4 Cil	• •	01/95	12/96	<b>NKBA07627</b>	Polia V / Polea V / V Pulley
	2.0 4 Cil	• •	01/95	12/96	<b>NKBA07627</b>	Polia V / Polea V / V Pulley
Polo	1.0 16V 4 Cil	•	01/03	12/07	<b>NKBA07636</b>	
	1.6 8V (EA111) 4 Cil	•	01/03	12/16	<b>NKBA07630</b>	
	2.0 8V 4 Cil	•	01/02	12/16	<b>NKBA07633</b>	
Polo Classic	1.4 8V 4 Cil	• •	01/97	12/01	<b>NKBA07630</b>	
	1.6 8V 4 Cil	• •	01/97	12/01	<b>NKBA07630</b>	
	1.8 8V 4 Cil	• •	01/97	12/01	<b>NKBA07631</b>	
Polo Sedan	1.6 8V (EA111) 4 Cil	• •	01/01	12/16	<b>NKBA07630</b>	
	2.0 8V 4 Cil	•	01/02	12/16	<b>NKBA07633</b>	
Quantum	1.8 4 Cil	• •	01/86	12/06	<b>NKBA07627</b>	Polia V / Polea V / V Pulley
	1.8 4 Cil	• •	01/95	12/06	<b>NKBA07628</b>	Polia Multi V / Polea Multi V / Multi V Pulley
	2.0 8V 4 Cil	• •	01/86	12/06	<b>NKBA07627</b>	Polia V / Polea V / V Pulley
	2.0 8V 4 Cil	• •	01/95	12/06	<b>NKBA07628</b>	Polia Multi V / Polea Multi V / Multi V Pulley
Santana	1.8 4 Cil	• •	01/84	12/09	<b>NKBA07627</b>	Polia V / Polea V / V Pulley
	1.8 4 Cil	• •	01/95	12/06	<b>NKBA07628</b>	Polia Multi V / Polea Multi V / Multi V Pulley
	2.0 4 Cil	• •	01/84	12/09	<b>NKBA07627</b>	Polia V / Polea V / V Pulley
	2.0 4 Cil	• •	01/95	12/09	<b>NKBA07628</b>	Polia Multi V / Polea Multi V / Multi V Pulley
Saveiro	1.6 8V (EA111) 4 Cil	• •	01/10	12/16	<b>NKBA07630</b>	
	1.6 AE 4 Cil	• •	11/89	12/93	<b>NKBA02944</b>	
	1.6 AP 8V 4 Cil	• •	01/84	06/85	<b>NKBA07627</b>	
	1.6 AP 8V 4 Cil	• •	01/95	12/10	<b>NKBA07628</b>	Polia Multi V / Polea Multi V / Multi V Pulley
	1.6 AP 8V 4 Cil	• •	07/85	12/09	<b>NKBA07627</b>	Polia V / Polea V / V Pulley
	1.8 AP 8V 4 Cil	• •	01/84	12/09	<b>NKBA07627</b>	Polia V / Polea V / V Pulley
	1.8 AP 8V 4 Cil	• •	01/95	12/09	<b>NKBA07628</b>	Polia Multi V / Polea Multi V / Multi V Pulley
	2.0 AP 8V 4 Cil	• •	01/95	12/09	<b>NKBA07628</b>	Polia Multi V / Polea Multi V / Multi V Pulley
SpaceFox	1.6 8V 4 Cil	• •	01/04	12/16	<b>NKBA07630</b>	
Voyage	1.0 8V 4 Cil	• •	01/10	12/14	<b>NKBA07630</b>	
	1.5 4 Cil	• •	01/82	07/85	<b>NKBA07625</b>	
	1.6 8V 4 Cil	• •	01/10	12/16	<b>NKBA07630</b>	
	1.6 AE 4 Cil	• •	11/89	12/93	<b>NKBA02944</b>	
	1.6 AP 8V 4 Cil	• •	01/82	12/94	<b>NKBA07627</b>	Polia V / Polea V / V Pulley
	1.8 8V 4 Cil	• •	01/84	12/94	<b>NKBA07627</b>	Polia V / Polea V / V Pulley

**Motor / Motor / Engine**

**FORD**

FORD	BF 161 6 Cil Diesel	• •	01/60	12/72	<b>NKBA02054</b>	
	Ford 6.6 Diesel	•	01/76	12/96	<b>NKBA02590</b>	Sem Tampa Traseira / Sin la Cubierta trazera / Without Back Cover

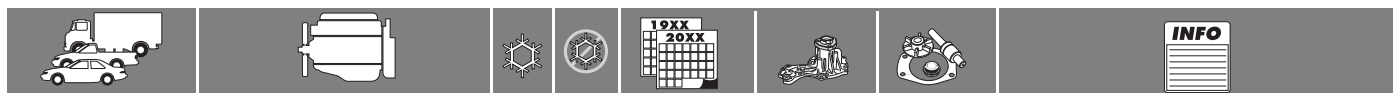

**Motor / Motor / Engine**

**FORD**

FORD Ford Pinto Diesel • • 01/73 12/83 **NKBA02092**

**GENERAL MOTORS**

GM 261 6 Cil Diesel • 01/60 12/81 **NKBA03128** NKBR03759

**M.W.M.**

MWM	MWM 4.07 TCA 4 Cil Diesel	•	01/01	12/14	<b>NKBA06575</b>	Engrenagem 3° / Engranaje 3° / Gear 3°
	MWM 4.08 TCE 4 Cil Diesel	•	01/05	06/08	<b>NKBA06574</b>	Engrenagem 0° / Engranaje 0° / Gear 0°
	MWM 6.10TCA 4 Cil Diesel	•	05/05	12/07	<b>NKBA06573</b>	Engrenagem com dentes retos
	MWM 6.12TCE 6 Cil Diesel	•	02/02	10/07	<b>NKBA06573</b>	Engrenagem com dentes retos
	MWM D225 3 Cil Diesel	•	01/73	01/83	<b>NKBA06576</b>	
	MWM D225 4 Cil Diesel	•	01/73	01/90	<b>NKBA06576</b>	
	MWM D225 6 Cil Diesel	•	01/73	01/83	<b>NKBA06576</b>	
	MWM D226 4 Cil Diesel	•	01/80	12/90	<b>NKBA06576</b>	Bosch/CAV / Bosch/CAV / Bosch/CAV
	MWM D229 3 Cil Diesel	•	01/80	12/90	<b>NKBA06576</b>	
	MWM D229 4 Cil Diesel	•	01/80	12/02	<b>NKBA06576</b>	
	MWM D229 6 Cil Diesel	•	01/75	12/90	<b>NKBA06576</b>	
	MWM D229 EC 6 Cil Diesel	•	01/80	12/90	<b>NKBA06576</b>	
	MWM Série 10 4 Cil Diesel	•	01/80	12/90	<b>NKBA06579</b>	
	MWM Série 10 6 Cil Diesel	•	01/80	12/90	<b>NKBA06579</b>	
	MWM Sprint 2.8 4T Diesel	•	01/96	12/02	<b>NKBA04340</b>	Turbo Diesel / Turbo Diesel / Diesel Turbo
	MWM Sprint 4 Cil Diesel	•	01/85	12/06	<b>NKBA06577</b>	Engrenagem 15° / Engranaje 15° / Gear 15°
	MWM TD229 EC 4 Cil Diesel	•	01/80	12/90	<b>NKBA06576</b>	NKBR06575
	MWM TD229 EC 6 Cil Diesel	•	01/80	12/90	<b>NKBA06578</b>	NKBR06575
	MWM4.2 Sprint Turbo 4 Cil Diesel	•	01/99	12/06	<b>NKBA06577</b>	Engrenagem 15° / Engranaje 15° / Gear 15°
	MWMSprint 4 Cil Diesel	•	01/85	12/06	<b>NKBA06577</b>	Engrenagem 15° / Engranaje 15° / Gear 15°

**MAXION**

MAXION Maxion S4/S4T Diesel • 10/92 12/97 **NKBA04333** NKBR04393 Sem Polia / Sin Polea / Without Pulley

**MERCEDES BENZ**

MERCEDES BENZ	OM 314 4 Cil Diesel	•	01/72	12/90	<b>NKBA05608</b>	NKBR05608
	OM 352 6 Cil Diesel	•	01/69	12/89	<b>NKBA05314</b>	NKBR051313 Sem Tampa / Sin la Cubierta / Without Cover
	OM 352 6 Cil Diesel	•	01/74	12/89	<b>NKBA05362</b>	NKBR05608 Rebaixado sem Tampa, Rotor com Diam. 87,5 mm. / Rebajado sin la Cubierta, el Rotor con Diam. 87.5 mm. / Lowered without Cover, Rotor with Diam. 87,5 mm.
	OM 352A 6 Cil Diesel	•	01/74	12/89	<b>NKBA05366</b>	NKBR051364 Rebaixado sem Tampa, Rotor com Diam. 95 mm. / Rebajado sin la Cubierta, el Rotor con Diam. 95 mm. / Lowered without Cover, Rotor with Diam. 95 mm.
	OM 352A 6 Cil Diesel	•	01/86	12/89	<b>NKBA05316</b>	NKBR051315 Sem Tampa, Rotor Diam. 95 mm / Sin la Cubierta, Rotor de Diam. 95 mm / Without Cover, Diam Rotor. 95 mm
	OM 355 5/6 Cil Diesel	•	01/79	12/92	<b>NKBA05355</b>	NKBR051356 Rotor 115 mm / Rotor 115 mm / Rotor 115 mm
	OM 355 5/6 Cil Diesel	•	01/80	12/92		NKBR051358 Rotor com Diam. 120,5 mm / Rotor con Diam. 120.5 mm / Rotor with Diam. 120,5 mm
	OM 364 4 Cil Diesel	•	01/90	12/98	<b>NKBA05609</b>	Com rolamento reforçado
	OM 364 4 Cil Diesel	•	01/90	12/98	<b>NKBA05610</b>	NKBR05709 Exceto motor eletrônico
	OM 364A 4 Cil Diesel	•	01/90	12/98	<b>NKBA05609</b>	Com rolamento reforçado
	OM 364A 4 Cil Diesel	•	01/90	12/98	<b>NKBA05610</b>	NKBR05709 Exceto motor eletrônico



**Motor / Motor / Engine**

**MERCEDES BENZ**

MERCEDES BENZ	OM 366 Ecológico 6 Cil Diesel	●	01/80	12/90	<b>NKBA05370</b>		Sem Tampa / Sin la Cubierta / Without Cover
	OM 366/366A 6 Cil Diesel	●	01/89	12/99	<b>NKBA05366</b>	NKBR051364	Sem Tampa Traseira / Sin la Cubierta trazera / Without Back Cover
	OM 366LA Intercooler 6 Cil Diesel	●	01/96	12/05	<b>NKBA05367</b>	NKBR051371	Com Tampa, Com Rolamento Reforçado / Con la Cubierta, Rodamiento Reforzado / With Cover, Havy duty bearing
	OM 366LA Intercooler 6 Cil Diesel	●	01/96	12/05	<b>NKBA05368</b>	NKBR051371	Sem Tampa, Com Rolamento Reforçado / Sin la Cubierta, Con Rodamiento Reforzado / Without cover, with strong bearing
	OM 447LA 6 Cil Diesel	●	01/90	12/06	<b>NKBA05372</b>	NKBR051373	Com Rotor de 136 mm / Con Rotor de 136 mm / With 136 mm Rotor
	OM 447LA 6 Cil Diesel	●	01/98	12/05	<b>NKBA05373</b>	NKBR051374	Com Rotor de 125 mm / Con Rotor de 125 mm / With 125 mm Rotor
	OM 457A Eletrônico 6 Cil Diesel	●	01/98	12/11	<b>NKBA05374</b>	NKBR051374	Com Rotor de 125 mm / Con Rotor de 125 mm / With 125 mm Rotor
	OM 457LA 6 Cil Diesel	●	01/05	12/08	<b>NKBA05375</b>		
	OM 460LA 6 Cil Diesel	●	01/05	12/08	<b>NKBA05375</b>		
	OM 904 4 Cil Diesel	●	01/80	12/11	<b>NKBA05380</b>	NKBR051375	
	OM 904LA 4 Cil Diesel	●	01/98	12/11	<b>NKBA05380</b>	NKBR051375	
	OM 906LA 6 Cil Diesel	●	01/80	12/11	<b>NKBA05380</b>	NKBR051375	
	OM 906LA 6 Cil Diesel	●	01/98	12/11	<b>NKBA05380</b>	NKBR051375	
	OM 926 4 Cil Diesel	●	01/98	12/11	<b>NKBA05381</b>		

**PERKINS**

PERKINS	3152 3 Cil Diesel	●	01/62	12/72	<b>NKBA04318</b>	NKBR04319	Com Polia / Con Polea / With Pulley
	4203 4 Cil Diesel	●	01/66	12/76	<b>NKBA03329</b>	NKBR04392	Com Polia / Con Polea / With Pulley
	4236 4 Cil Diesel	●	01/76	12/81	<b>NKBA04325</b>	NKBR07391	Com Polia / Con Polea / With Pulley
	4236 4 Cil Diesel	●	01/76	12/81	<b>NKBA04326</b>	NKBR07391	Sem Polia / Sin Polea / Without Pulley
	4248 4 Cil Diesel	●	01/76	12/86	<b>NKBA04325</b>	NKBR07391	Com Polia / Con Polea / With Pulley
	4248 4 Cil Diesel	●	01/76	12/86	<b>NKBA04326</b>	NKBR07391	Sem Polia / Sin Polea / Without Pulley
	6357 6 Cil Diesel	●	01/69	12/81	<b>NKBA04553</b>	NKBR04554	Com Polia Simples de 5 1/2" / Con Polea Simple de 5 1/2" / With Single Pulley of 5 1/2"
	6357 6 Cil Diesel	●	01/69	12/81	<b>NKBA04554</b>	NKBR04554	Sem Polia / Sin Polea / Without Pulley
	AD 3152 3 Cil Diesel	●	01/89	12/99	<b>NKBA04318</b>		Com Polia / Con Polea / With Pulley
	Q20B4236 4 Cil Diesel	●	01/84	12/92	<b>NKBA04325</b>	NKBR07391	Com Polia / Con Polea / With Pulley
	Q20B4236 4 Cil Diesel	●	01/84	12/92	<b>NKBA04332</b>	NKBR07391	Sem Polia / Sin Polea / Without Pulley
	Q20B63544 6 Cil Diesel	●	01/85	12/95	<b>NKBA04560</b>	NKBR04561	Sem Polia / Sin Polea / Without Pulley

**SCANIA**

SCANIA	DS11 6 Cil Diesel	●	01/75	12/76	<b>NKBA11982</b>	NKBR11983	Com Filtro Dentro / Con el Filtro Adentro / With Filter Inside
	DS11 6 Cil Diesel	●	01/83	12/93	<b>NKBA11984</b>	NKBR11985	
	DSC 12 6 Cil Diesel	●	01/05	12/09	<b>NKBA11981</b>		rotor com diâmetro de 112mm
	NA 330 6 Cil Diesel	●	01/98	12/04	<b>NKBA11980</b>		rotor com diâmetro de 105mm
	NA 360 6 Cil Diesel	●	01/98	12/04	<b>NKBA11980</b>		rotor com diâmetro de 105mm
	NA 360 6 Cil Diesel	●	01/05	12/09	<b>NKBA11981</b>		rotor com diâmetro de 112mm
	NA 400 6 Cil Diesel	●	01/98	12/04	<b>NKBA11980</b>		rotor com diâmetro de 105mm
	NA 400 6 Cil Diesel	●	01/05	12/09	<b>NKBA11981</b>		rotor com diâmetro de 112mm
	NA 420 6 Cil Diesel	●	01/98	12/04	<b>NKBA11980</b>		rotor com diâmetro de 105mm
	NA 420 6 Cil Diesel	●	01/05	12/09	<b>NKBA11981</b>		rotor com diâmetro de 112mm

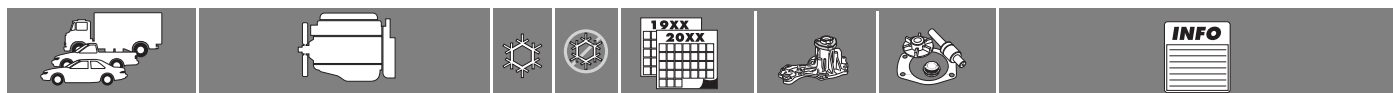

**Motor / Motor / Engine**

**SCANIA**

SCANIA	NA 480 6 Cil Diesel	●	01/98	12/04	<b>NKBA11980</b>		rotor com diâmetro de 105mm
	NA 480 6 Cil Diesel	●	01/05	12/09	<b>NKBA11981</b>		rotor com diâmetro de 112mm
	NZ 330 6 Cil Diesel	●	01/98	12/04	<b>NKBA11980</b>		rotor com diâmetro de 105mm
	NZ 330 6 Cil Diesel	●	01/05	12/09	<b>NKBA11981</b>		rotor com diâmetro de 112mm
	NZ 360 6 Cil Diesel	●	01/98	12/04	<b>NKBA11980</b>		rotor com diâmetro de 105mm
	NZ 360 6 Cil Diesel	●	01/05	12/09	<b>NKBA11981</b>		rotor com diâmetro de 112mm
	NZ 400 6 Cil Diesel	●	01/98	12/04	<b>NKBA11980</b>		rotor com diâmetro de 105mm
	NZ 400 6 Cil Diesel	●	01/05	12/09	<b>NKBA11981</b>		rotor com diâmetro de 112mm
	NZ 420 6 Cil Diesel	●	01/98	12/04	<b>NKBA11980</b>		rotor com diâmetro de 105mm
	NZ 420 6 Cil Diesel	●	01/05	12/09	<b>NKBA11981</b>		rotor com diâmetro de 112mm
	NZ 480 6 Cil Diesel	●	01/98	12/04	<b>NKBA11980</b>		rotor com diâmetro de 105mm
	NZ 480 6 Cil Diesel	●	01/05	12/09	<b>NKBA11981</b>		rotor com diâmetro de 112mm

**Máquinas Agrícolas & Fora de Estrada / Vehiculos Fuera de Carretera / Off Highway**

**AGCO**

4400 Trator	3 Cil Diesel	●	01/76	12/86	<b>NKBA33582</b>	NKBR33478	Sem Tampa Traseira / Sin la Cubierta trazera / Without Back Cover
4500 Trator	3 Cil Diesel	●	01/76	12/86	<b>NKBA33582</b>	NKBR33478	Sem Tampa Traseira / Sin la Cubierta trazera / Without Back Cover
4600 Trator	3 Cil Diesel	●	01/76	12/86	<b>NKBA33582</b>	NKBR33478	Sem Tampa Traseira / Sin la Cubierta trazera / Without Back Cover
4610 Trator	3 Cil Diesel	●	01/76	12/86	<b>NKBA33582</b>	NKBR33478	Sem Tampa Traseira / Sin la Cubierta trazera / Without Back Cover
5000 Trator	Diesel	●	01/81	12/91	<b>NKBA33582</b>	NKBR33478	Sem Tampa Traseira / Sin la Cubierta trazera / Without Back Cover
5600 Trator	Diesel	●	01/81	12/91	<b>NKBA33582</b>	NKBR33478	Sem Tampa Traseira / Sin la Cubierta trazera / Without Back Cover
5610 Trator	Diesel	●	01/81	12/91	<b>NKBA33582</b>	NKBR33478	Sem Tampa Traseira / Sin la Cubierta trazera / Without Back Cover
6600 Trator	Diesel	●	01/81	12/91	<b>NKBA33582</b>	NKBR33478	Sem Tampa Traseira / Sin la Cubierta trazera / Without Back Cover
6610 Trator	Diesel	●	01/81	12/91	<b>NKBA33582</b>	NKBR33478	Sem Tampa Traseira / Sin la Cubierta trazera / Without Back Cover
FA120 Trator	MWM TD229 EC 6 Cil Diesel	●	01/80	12/90	<b>NKBA06578</b>	NKBR06575	
FB80 Trator	MWM D229 4 Cil Diesel	●	01/80	12/90	<b>NKBA06576</b>		
FD9 Trator	MWM TD229 EC 6 Cil Diesel	●	01/80	12/90	<b>NKBA06578</b>	NKBR06575	
FD9B Trator	MWM TD229 EC 6 Cil Diesel	●	01/80	12/90	<b>NKBA06578</b>	NKBR06575	
FG70 Trator	OM 352 6 Cil Diesel	●	01/80	12/90	<b>NKBA05314</b>	NKBR051313	Sem Tampa / Sin la Cubierta / Without Cover
	OM 352A 6 Cil Diesel	●	01/80	12/90	<b>NKBA05316</b>	NKBR051315	Sem Tampa, Rotor Diam. 95 mm / Sin la Cubierta, Rotor de Diam. 95 mm / Without Cover, Diam Rotor. 95 mm
FG75 Trator	OM 352 6 Cil Diesel	●	01/80	12/90	<b>NKBA05314</b>	NKBR051313	Sem Tampa / Sin la Cubierta / Without Cover
	OM 352A 6 Cil Diesel	●	01/80	12/90	<b>NKBA05316</b>	NKBR051315	Sem Tampa, Rotor Diam. 95 mm / Sin la Cubierta, Rotor de Diam. 95 mm / Without Cover, Diam Rotor. 95 mm
FH200 Trator	MWM TD229 EC 6 Cil Diesel	●	01/80	12/90	<b>NKBA06578</b>	NKBR06575	
FR10B Trator	MWM TD229 EC 6 Cil Diesel	●	01/80	12/90	<b>NKBA06578</b>	NKBR06575	
FR12B Trator	MWM TD229 EC 6 Cil Diesel	●	01/80	12/90	<b>NKBA06578</b>	NKBR06575	





**Máquinas Agrícolas & Fora de Estrada / Vehiculos Fuera de Carretera / Off Highway**

**AGCO**

FR14B Trator	MWM TD229 EC 6 Cil Diesel	●	01/80	12/90	<b>NKBA06578</b>	NKBR06575	
Trator	MWM TD229 EC 6 Cil Diesel	●	01/80	12/90	<b>NKBA06578</b>	NKBR06575	
	OM 352 6 Cil Diesel	●	01/80	12/90	<b>NKBA05314</b>	NKBR051313	Sem Tampa / Sin la Cubierta / Without Cover

**CARBORUNDUM**

Motobomba	MWM D229 3 Cil Diesel	●	01/80	12/90	<b>NKBA06576</b>		
	MWM D229 4 Cil Diesel	●	01/80	12/90	<b>NKBA06576</b>		
	MWM D229 6 Cil Diesel	●	01/80	12/90	<b>NKBA06576</b>		

**CASE**

2470	Scania Diesel	●	01/78	12/88	<b>NKBA11982</b>	NKBR11983	
4440	Scania Diesel	●	01/80	12/90	<b>NKBA11982</b>	NKBR11983	
580H	Perkins 4236 4 Cil Diesel	●	01/80	12/90	<b>NKBA04325</b>	NKBR07391	Com Polia / Con Polea / With Pulley
	Perkins 4236 4 Cil Diesel	●	01/80	12/90	<b>NKBA04326</b>	NKBR07391	Sem Polia / Sin Polea / Without Pulley
	Perkins 4248 4 Cil Diesel	●	01/80	12/90	<b>NKBA04325</b>	NKBR07391	Com Polia / Con Polea / With Pulley
	Perkins 4248 4 Cil Diesel	●	01/80	12/90	<b>NKBA04326</b>	NKBR07391	Sem Polia / Sin Polea / Without Pulley
Escavadeira	MWM D229 6 Cil Diesel	●	01/80	12/90	<b>NKBA06576</b>		

**CBT**

Trator 1000	Perkins 4203 4 Cil Diesel	●	01/66	12/76	<b>NKBA03329</b>	NKBR04392	Com Polia / Con Polea / With Pulley
Trator 1065	OM 314 4 Cil Diesel	●	01/72	12/82	<b>NKBA05608</b>	NKBR05608	
Trator 1090A	Perkins 6.357 6 Cil Diesel	●	01/69	12/81	<b>NKBA04553</b>	NKBR04554	Com Polia Simples de 5 1/2" / Con Polea Simple de 5 1/2" / With Single Pulley of 5 1/2"
	Perkins 6.357 6 Cil Diesel	●	01/69	12/81	<b>NKBA04554</b>	NKBR04554	Sem Polia / Sin Polea / Without Pulley
Trator 1105	OM 352 6 Cil Diesel	●	01/73	12/83	<b>NKBA05314</b>	NKBR051313	Sem Tampa / Sin la Cubierta / Without Cover
Trator 8440	MWM D229 4 Cil Diesel	●	01/80	12/90	<b>NKBA06576</b>		
Trator 8450	MWM TD229 EC 4 Cil Diesel	●	01/80	12/90	<b>NKBA06578</b>	NKBR06575	

**CLARK**

CFY-20	GM 151 4 Cil Diesel	●	01/63	12/71	<b>NKBA03135</b>		
CFY-25	GM 151 4 Cil Diesel	●	01/63	12/71	<b>NKBA03135</b>		
CFY-40	BF 161 6 Cil Diesel	●	01/60	12/72	<b>NKBA02054</b>		
CFY-50	BF 161 6 Cil Diesel	●	01/60	12/72	<b>NKBA02054</b>		
CFY-60	GM 250 6 Cil Diesel	●	01/69	12/83	<b>NKBA03135</b>		
CHY-100	GM 250 6 Cil Diesel	●	01/69	12/83	<b>NKBA03135</b>		
CHY-120	GM 250 6 Cil Diesel	●	01/69	12/83	<b>NKBA03135</b>		
CHY-70	GM 250 6 Cil Diesel	●	01/69	12/83	<b>NKBA03135</b>		
CHY-80	GM 250 6 Cil Diesel	●	01/69	12/83	<b>NKBA03135</b>		

**DYNAPAC**

Rolo Compactador	MWM D229 3 Cil Diesel	●	01/80	12/90	<b>NKBA06576</b>		
	MWM D229 4 Cil Diesel	●	01/80	12/90	<b>NKBA06576</b>		
	MWM D229 6 Cil Diesel	●	01/80	12/90	<b>NKBA06576</b>		
	MWM TD229 6 Cil Diesel	●	01/80	12/90	<b>NKBA06578</b>	NKBR06575	
	Perkins QB20B63544 6 Cil Diesel	●	01/80	12/90	<b>NKBA04560</b>	NKBR04561	Sem Polia / Sin Polea / Without Pulley

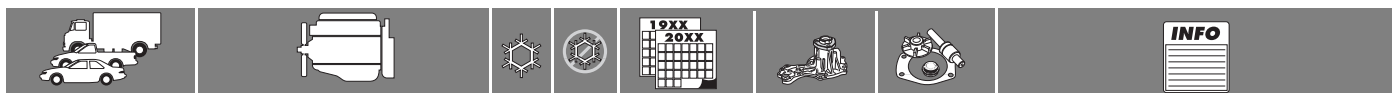

**Máquinas Agrícolas & Fora de Estrada / Vehiculos Fuera de Carretera / Off Highway**

**FIAT ALLIS**

Trator de Esteiras	Diesel	●	01/80	12/90	<b>NKBA06576</b>		
	MWM TD229 6 Cil Diesel	●	01/80	12/90	<b>NKBA06578</b>	NKBR06575	
Trator Rodoviário	OM 352 6 Cil Diesel	●	01/80	12/90	<b>NKBA05314</b>	NKBR051313	Sem Tampa / Sin la Cubierta / Without Cover
	OM 352A 6 Cil Diesel	●	01/80	12/90	<b>NKBA05316</b>	NKBR051315	Sem Tampa, Rotor Diam. 95 mm / Sin la Cubierta, Rotor de Diam. 95 mm / Without Cover, Diam Rotor. 95 mm

**HYSTER**

110J	GM 250 6 Cil Diesel	●	01/69	12/92	<b>NKBA03135</b>		
130J	GM 250 6 Cil Diesel	●	01/69	12/92	<b>NKBA03135</b>		
150J	GM 250 6 Cil Diesel	●	01/69	12/92	<b>NKBA03135</b>		
40K	GM 151 4 Cil Diesel	●	01/69	12/92	<b>NKBA03135</b>		
42361	Perkins 4236 4 Cil Diesel	●	01/69	01/86	<b>NKBA04326</b>	NKBR07391	Sem Polia / Sin Polea / Without Pulley
50K	GM 151 4 Cil Diesel	●	01/69	12/92	<b>NKBA03135</b>		
60J	GM 250 6 Cil Diesel	●	01/69	12/92	<b>NKBA03135</b>		
70J	GM 250 6 Cil Diesel	●	01/69	12/92	<b>NKBA03135</b>		
80J	GM 250 6 Cil Diesel	●	01/69	12/92	<b>NKBA03135</b>		
8596	Perkins 4236 4 Cil Diesel	●	01/76	01/86	<b>NKBA04326</b>	NKBR07391	Sem Polia / Sin Polea / Without Pulley
8676	Perkins 4236 4 Cil Diesel	●	01/69	01/79	<b>NKBA04326</b>	NKBR07391	Sem Polia / Sin Polea / Without Pulley
90J	GM 250 6 Cil Diesel	●	01/69	12/92	<b>NKBA03135</b>		

**IDEAL**

Colheitadeira	MWM D229 3 Cil Diesel	●	01/80	12/90	<b>NKBA06576</b>		
	MWM D229 6 Cil Diesel	●	01/80	12/90	<b>NKBA06576</b>		
	MWM TD229 6 Cil Diesel	●	01/80	12/90	<b>NKBA06578</b>	NKBR06575	
	MWM TD229 EC 6 Cil Diesel	●	01/80	12/90	<b>NKBA06578</b>	NKBR06575	
	OM 366 6 Cil Diesel	●	01/80	12/90	<b>NKBA05366</b>	NKBR051364	Sem Tampa / Sin la Cubierta / Without Cover
	OM 366 Turbo 6 Cil Diesel	●	01/80	12/90	<b>NKBA05366</b>	NKBR051364	Sem Tampa / Sin la Cubierta / Without Cover

**MALTRA**

Maltra	MWM D229 EC 6 Cil	●	01/80	12/90	<b>NKBA06576</b>		
	MWM TD229 EC 6 Cil	●	01/80	12/90	<b>NKBA06578</b>	NKBR06575	

**MARCOPLAN**

E-300.00	BF 161 6 Cil Diesel	●	01/60	12/72	<b>NKBA02054</b>		
	Perkins 6.357 6 Cil Diesel	●	01/69	12/81	<b>NKBA04553</b>	NKBR04554	Com Polia Simples de 5 1/2" / Con Polea Simple de 5 1/2" / With Single Pulley of 5 1/2"
	Perkins 6.357 6 Cil Diesel	●	01/69	12/81	<b>NKBA04554</b>	NKBR04554	Sem Polia / Sin Polea / Without Pulley
E-700.00	GM 261 6 Cil Diesel	●	01/60	12/81	<b>NKBA03128</b>	NKBR03759	
	Perkins 6.357 6 Cil Diesel	●	01/69	12/81	<b>NKBA04553</b>	NKBR04554	Com Polia Simples de 5 1/2" / Con Polea Simple de 5 1/2" / With Single Pulley of 5 1/2"
	Perkins 6.357 6 Cil Diesel	●	01/69	12/81	<b>NKBA04554</b>	NKBR04554	Sem Polia / Sin Polea / Without Pulley

**MASSEY FERGUSON**

MF 3366	Perkins 6.357 6 Cil Diesel	●	01/70	12/80	<b>NKBA04554</b>	NKBR04554	Sem Polia / Sin Polea / Without Pulley
MF 5265	Perkins 4203 4 Cil Diesel	●	01/66	12/76	<b>NKBA03329</b>	NKBR04392	Com Polia / Con Polea / With Pulley
MF 65	Perkins 4203 4 Cil Diesel	●	01/66	12/76	<b>NKBA03329</b>	NKBR04392	Com Polia / Con Polea / With Pulley



**Máquinas Agrícolas & Fora de Estrada / Vehiculos Fuera de Carretera / Off Highway**

**MASSEY FERGUSON**

MF 85	Perkins 4236 4 Cil Diesel	●	01/76	12/86	<b>NKBA04325</b>	NKBR07391	Com Polia / Con Polea / With Pulley
	Perkins 4236 4 Cil Diesel	●	01/76	12/86	<b>NKBA04326</b>	NKBR07391	Sem Polia / Sin Polea / Without Pulley
	Perkins 4248 4 Cil Diesel	●	01/76	12/86	<b>NKBA04325</b>	NKBR07391	Com Polia / Con Polea / With Pulley
	Perkins 4248 4 Cil Diesel	●	01/76	12/86	<b>NKBA04326</b>	NKBR07391	Sem Polia / Sin Polea / Without Pulley
MF 95	Perkins 6.357 6 Cil Diesel	●	01/70	12/80	<b>NKBA04554</b>	NKBR04554	Sem Polia / Sin Polea / Without Pulley

**PUTZMEISTER**

Bomba de Concreto	MWM D229 6 Cil Diesel	●	01/80	12/90	<b>NKBA06576</b>		
	MWM TD229 6 Cil Diesel	●	01/80	12/90	<b>NKBA06578</b>	NKBR06575	

**VALMET**

118	MWM D229 3 Cil Diesel	●	01/80	01/90	<b>NKBA06576</b>		
	MWM D229 4 Cil Diesel	●	01/80	01/90	<b>NKBA06576</b>		
	MWM D229 6 Cil Diesel	●	01/80	01/90	<b>NKBA06576</b>		
138	MWM D229 3 Cil Diesel	●	01/80	01/90	<b>NKBA06576</b>		
	MWM D229 4 Cil Diesel	●	01/80	01/90	<b>NKBA06576</b>		
	MWM D229 6 Cil Diesel	●	01/80	01/90	<b>NKBA06576</b>		
1780	MWM D229 3 Cil Diesel	●	01/80	12/90	<b>NKBA06576</b>		
	MWM D229 4 Cil Diesel	●	01/80	12/90	<b>NKBA06576</b>		
	MWM D229 6 Cil Diesel	●	01/80	12/90	<b>NKBA06576</b>		
68	MWM D229 3 Cil Diesel	●	01/80	01/90	<b>NKBA06576</b>		
	MWM D229 4 Cil Diesel	●	01/80	01/90	<b>NKBA06576</b>		
	MWM D229 6 Cil Diesel	●	01/80	01/90	<b>NKBA06576</b>		
88	MWM D229 3 Cil Diesel	●	01/80	01/90	<b>NKBA06576</b>		
	MWM D229 4 Cil Diesel	●	01/80	01/90	<b>NKBA06576</b>		
	MWM D229 6 Cil Diesel	●	01/80	01/90	<b>NKBA06576</b>		
CF	MWM D229 3 Cil Diesel	●	01/80	12/90	<b>NKBA06576</b>		
	MWM D229 4 Cil Diesel	●	01/80	12/90	<b>NKBA06576</b>		
	MWM D229 6 Cil Diesel	●	01/80	12/90	<b>NKBA06576</b>		
Empilhadeira	MWM D229 3 Cil Diesel	●	01/80	12/90	<b>NKBA06576</b>		
	MWM D229 4 Cil Diesel	●	01/80	12/90	<b>NKBA06576</b>		
	MWM D229 6 Cil Diesel	●	01/80	12/90	<b>NKBA06576</b>		
TA 985	MWM TD229 EC 4 Cil Diesel	●	01/80	12/90	<b>NKBA06578</b>	NKBR06575	
TM 78	MWM D229 4 Cil Diesel	●	01/80	12/90	<b>NKBA06576</b>		
TM 88	MWM D229 4 Cil Diesel	●	01/80	12/90	<b>NKBA06576</b>		
TM 880	MWM D229 4 Cil Diesel	●	01/80	12/90	<b>NKBA06576</b>		
TM 885	MWM D229 4 Cil Diesel	●	01/80	12/90	<b>NKBA06576</b>		
TS 78	MWM D229 4 Cil Diesel	●	01/80	12/90	<b>NKBA06576</b>		
TS 88	MWM D229 4 Cil Diesel	●	01/80	12/90	<b>NKBA06576</b>		
TS 980	MWM TD229 4 Cil Diesel	●	01/80	12/90	<b>NKBA06578</b>	NKBR06575	
TS 985	MWM TD229 4 Cil Diesel	●	01/80	12/90	<b>NKBA06576</b>		
TV 118	MWM D229 6 Cil Diesel	●	01/80	12/90	<b>NKBA06576</b>		
TV 138	MWM TD229 6 Cil Diesel	●	01/80	12/90	<b>NKBA06576</b>		
TV 68	MWM D229 3 Cil Diesel	●	01/80	12/90	<b>NKBA06576</b>		

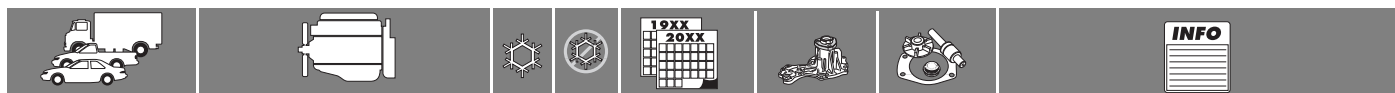

**Máquinas Agrícolas & Fora de Estrada / Vehiculos Fuera de Carretera / Off Highway**

**VALMET**

TV 78	MWM D229 4 Cil Diesel	●	01/80	12/90	<b>NKBA06576</b>	
TV 88	MWM D229 4 Cil Diesel	●	01/80	12/90	<b>NKBA06576</b>	
VA 1580	MWM TD229 EC 6 Cil Diesel	●	01/80	12/90	<b>NKBA06578</b>	NKBR06575
VA 1780	MWM TD229 EC 6 Cil Diesel	●	01/80	12/90	<b>NKBA06578</b>	NKBR06575
VB 685	MWM D229 3 Cil Diesel	●	01/80	12/90	<b>NKBA06576</b>	
VE 78	MWM D229 4 Cil Diesel	●	01/80	12/90	<b>NKBA06576</b>	
VE 88	MWM D229 4 Cil Diesel	●	01/80	12/90	<b>NKBA06576</b>	
VM 128	MWM D229 6 Cil Diesel	●	01/80	12/90	<b>NKBA06578</b>	NKBR06575
VM 1280	MWM D229 6 Cil Diesel	●	01/80	12/90	<b>NKBA06578</b>	NKBR06575
VM 1580	MWM TD229 EC 6 Cil Diesel	●	01/80	12/90	<b>NKBA06578</b>	NKBR06575
VM 1780	MWM TD229 EC 6 Cil Diesel	●	01/80	12/90	<b>NKBA06578</b>	NKBR06575
VM 68	MWM D229 3 Cil Diesel	●	01/80	12/90	<b>NKBA06576</b>	
VM 685	MWM D229 3 Cil Diesel	●	01/80	12/90	<b>NKBA06576</b>	
VM 78	MWM D229 4 Cil Diesel	●	01/80	12/90	<b>NKBA06576</b>	
VM 88	MWM D229 4 Cil Diesel	●	01/80	12/90	<b>NKBA06576</b>	
VM 985	MWM TD229 EC 4 Cil Diesel	●	01/80	12/90	<b>NKBA06576</b>	
VO 78	MWM D229 4 Cil Diesel	●	01/80	12/90	<b>NKBA06576</b>	
VO 88	MWM D229 4 Cil Diesel	●	01/80	12/90	<b>NKBA06576</b>	
VP 78	MWM D229 4 Cil Diesel	●	01/80	12/90	<b>NKBA06576</b>	
VP 88	MWM D229 4 Cil Diesel	●	01/80	12/90	<b>NKBA06576</b>	
VR 128	MWM D229 6 Cil Diesel	●	01/80	12/90	<b>NKBA06578</b>	NKBR06575
VR 148	MWM TD229 6 Cil Diesel	●	01/80	12/90	<b>NKBA06576</b>	
VR 78	MWM D229 4 Cil Diesel	●	01/80	12/90	<b>NKBA06576</b>	
VR 88	MWM D229 4 Cil Diesel	●	01/80	12/90	<b>NKBA06576</b>	
VR 985	MWM TD229 4 Cil Diesel	●	01/80	12/90	<b>NKBA06576</b>	
VS 128	MWM D229 6 Cil Diesel	●	01/80	12/90	<b>NKBA06576</b>	
VS 138	MWM TD229 6 Cil Diesel	●	01/80	12/90	<b>NKBA06576</b>	
VS 148	MWM TD229 6 Cil Diesel	●	01/80	12/90	<b>NKBA06576</b>	
VS 685	MWM D229 3 Cil Diesel	●	01/80	12/90	<b>NKBA06576</b>	
VS 78	MWM D229 4 Cil Diesel	●	01/80	12/90	<b>NKBA06576</b>	
VS 88	MWM D229 4 Cil Diesel	●	01/80	12/90	<b>NKBA06576</b>	

**VOLVO**

Penta Marítimo	MWM TBD229 EC 6 Cil Diesel	●	01/80	12/90	<b>NKBA06578</b>	NKBR06575
	MWM TD229 6 Cil Diesel	●	01/80	12/90	<b>NKBA06578</b>	NKBR06575

**YALE**

51C-050	BF 161 6 Cil Diesel	●	01/60	12/72	<b>NKBA02054</b>	
51P-030	BF 161 6 Cil Diesel	●	01/60	12/72	<b>NKBA02054</b>	
51P-040	BF 161 6 Cil Diesel	●	01/60	12/72	<b>NKBA02054</b>	
51P-050	BF 161 6 Cil Diesel	●	01/60	12/72	<b>NKBA02054</b>	

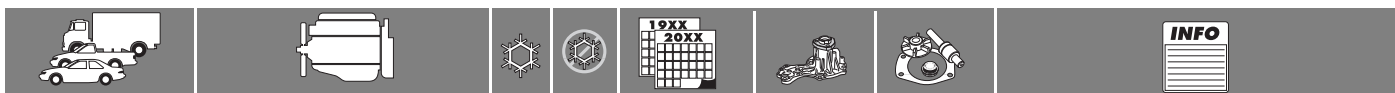

**Máquinas Agrícolas & Fora de Estrada / Vehiculos Fuera de Carretera / Off Highway**

**YALE**

83P-060	GM 250 6 Cil Diesel	●	01/69	12/92	NKBA03135	
83P-080	GM 250 6 Cil Diesel	●	01/69	12/92	NKBA03135	
83P-100	GM 250 6 Cil Diesel	●	01/69	12/92	NKBA03135	

**Caminhões & Ônibus / Camiones y Autobuses / Heavy Trucks & Buses**

**AGRALE**

1800	MWM D229 4 Cil Diesel	●	01/83	12/93	NKBA06576	
7000	MWM D229 4 Cil Diesel	●	01/83	12/02	NKBA06576	
7500	MWM TD229 EC 4 Cil Diesel	●	01/80	12/90	NKBA06578	NKBR06575
8500	4.12TCE 4 Cil Diesel	●	05/05	12/07	NKBA06573	Engrenagem com dentes retos
9200.	4.12TCE 4 Cil Diesel	●	05/05	12/07	NKBA06573	Engrenagem com dentes retos
BX 100	MWM TD229 EC 4 Cil Diesel	●	01/80	12/90	NKBA06576	
BX 130	MWM D229 6 Cil Diesel	●	01/80	12/90	NKBA06576	
BX 4.130	MWM D229 6 Cil Diesel	●	01/80	12/90	NKBA06576	
BX 4.150	MWM TD229 EC 6 Cil Diesel	●	01/80	12/90	NKBA06578	NKBR06575
BX 410	MWM TD229 EC 4 Cil Diesel	●	01/80	12/90	NKBA06576	
BX 490	MWM D229 4 Cil Diesel	●	01/80	12/90	NKBA06576	
BX 90	MWM D229 4 Cil Diesel	●	01/80	12/90	NKBA06576	
TX 1600	MWM D229 3 Cil Diesel	●	01/80	12/90	NKBA06576	
TX1600	MWM D229 3 Cil Diesel	●	01/80	12/90	NKBA06576	

**FORD**

1215 Cargo	6BT-5.9 6 Cil Diesel	●	01/76	11/86	NKBA10731	
	6BTA-5.9 6 Cil Diesel	●	01/76	11/86	NKBA10731	
	6BTAA-5.9 6 Cil Diesel	●	01/76	11/86	NKBA10731	
	Ford 6.6 Diesel	●	01/76	11/86	NKBA02590	Sem Tampa Traseira / Sin la Cubierta trazera / Without Back Cover
1217 Cargo	6BT-5.9 6 Cil Diesel	●	01/76	11/86	NKBA10731	
	6BTA-5.9 6 Cil Diesel	●	01/76	11/86	NKBA10731	
	6BTAA-5.9 6 Cil Diesel	●	01/76	11/86	NKBA10731	
1218 Cargo	Ford 6.6 Diesel	●	01/76	11/86	NKBA02590	Sem Tampa Traseira / Sin la Cubierta trazera / Without Back Cover
1317 Cargo	CUMMINS ISBE 3.9L 4 Cil Diesel	●	01/05	12/11	NKBA10733	Rotor de 82mm
1415 Cargo	6BT-5.9 6 Cil Diesel	●	01/76	11/86	NKBA10731	
	6BTA-5.9 6 Cil Diesel	●	01/76	11/86	NKBA10731	
	6BTAA-5.9 6 Cil Diesel	●	01/76	11/86	NKBA10731	
	Ford 6.6 Diesel	●	01/76	11/86	NKBA02590	Sem Tampa Traseira / Sin la Cubierta trazera / Without Back Cover
1417 Cargo	6BT-5.9 6 Cil Diesel	●	01/76	11/86	NKBA10731	
	6BTA-5.9 6 Cil Diesel	●	01/76	11/86	NKBA10731	
	6BTAA-5.9 6 Cil Diesel	●	01/76	11/86	NKBA10731	
1418 Cargo	Ford 6.6 Diesel	●	01/76	11/86	NKBA02590	Sem Tampa Traseira / Sin la Cubierta trazera / Without Back Cover
1422 Cargo	Cummins 6CT 8.3 Diesel	●	01/80	12/90	NKBA10732	

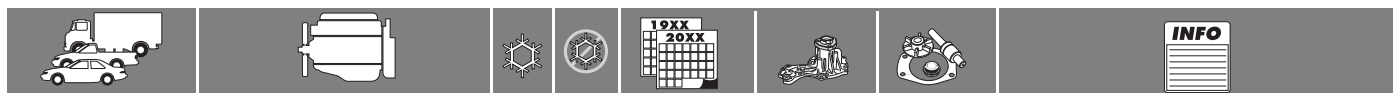

**Caminhões & Ônibus / Camiones y Autobuses / Heavy Trucks & Buses**

**FORD**

1517 Cargo	CUMMINS ISBE 3.9L 4 Cil Diesel	●	01/05	12/11	<b>NKBA10733</b>		Rotor de 82mm
1615 Cargo	Ford 6.6 Diesel	●	01/76	11/86	<b>NKBA02590</b>		Sem Tampa Traseira / Sin la Cubierta trazera / Without Back Cover
1617 Cargo	6BT-5.9 6 Cil Diesel	●	01/76	11/86	<b>NKBA10731</b>		
	6BTA-5.9 6 Cil Diesel	●	01/76	11/86	<b>NKBA10731</b>		
	6BTAA-5.9 6 Cil Diesel	●	01/76	11/86	<b>NKBA10731</b>		
1618 Cargo	Ford 6.6 Diesel	●	01/76	11/86	<b>NKBA02590</b>		Sem Tampa Traseira / Sin la Cubierta trazera / Without Back Cover
1622 Cargo	Cummins 6CT 8.3 Diesel	●	01/80	12/90	<b>NKBA10732</b>		
1717 Cargo	CUMMINS ISBE 3.9L 4 Cil Diesel	●	01/05	12/11	<b>NKBA10733</b>		Rotor de 82mm
1722 Cargo	CUMMINS ISBE 5.9L 6 Cil Diesel	●	01/06	12/11	<b>NKBA10733</b>		Rotor de 82mm
1932 Cargo	CUMMINS 8.3L 6CIL 6 Cil Diesel	●	01/06	12/12	<b>NKBA10734</b>		Rotor 105mm
1933 Cargo	CUMMINS 8.9 ISBE 6 Cil Diesel		01/12	12/17	<b>NKBA10734</b>		Rotor 105mm
2322 Cargo	Cummins 6CT 8.3 Diesel	●	01/80	12/90	<b>NKBA10732</b>		
2422 Cargo	Cummins 6CT 8.3 Diesel	●	01/80	12/90	<b>NKBA10732</b>		
	CUMMINS ISBE 5.9L 6 Cil Diesel	●	01/06	12/11	<b>NKBA10733</b>		Rotor de 82mm
2428 Cargo	CUMMINS ISBE 5.9L 6 Cil Diesel	●	01/06	12/11	<b>NKBA10733</b>		Rotor de 82mm
2622 Cargo	CUMMINS ISBE 5.9L 6 Cil Diesel	●	01/06	12/11	<b>NKBA10733</b>		Rotor de 82mm
2628 Cargo	CUMMINS ISBE 5.9L 6 Cil Diesel	●	01/06	12/11	<b>NKBA10733</b>		Rotor de 82mm
2632 Cargo	CUMMINS 8.3L 6CIL 6 Cil Diesel	●	01/06	12/12	<b>NKBA10734</b>		Rotor 105mm
2932 Cargo	CUMMINS 8.3L 6CIL 6 Cil Diesel	●	01/06	12/12	<b>NKBA10734</b>		Rotor 105mm
3133 Cargo	CUMMINS 8.9 ISBE 6 Cil Diesel		01/12	12/17	<b>NKBA10734</b>		Rotor 105mm
3224 Cargo	Cummins 6CTAA 8.3 Diesel	●	01/80	12/90	<b>NKBA10732</b>		
3530 Cargo	Cummins 6CTAA 8.3 Diesel	●	01/80	12/90	<b>NKBA10732</b>		
815 Cargo	CUMMINS ISBE 3.9L 4 Cil Diesel	●	01/05	12/11	<b>NKBA10733</b>		Rotor de 82mm
Cargo	Ford 6.6 Diesel	●	01/76	11/86	<b>NKBA02590</b>		Sem Tampa Traseira / Sin la Cubierta trazera / Without Back Cover
	MWM D229 6 Cil Diesel	●	01/80	12/90	<b>NKBA06576</b>		
F 11000	MWM 229 6 Cil Diesel	●	01/80	12/90	<b>NKBA06576</b>		
	Perkins 6357 6 Cil Diesel	●	01/79	12/89	<b>NKBA04553</b>	NKBR04554	Com Polia Simples de 5 1/2" / Con Polea Simple de 5 1/2" / With Single Pulley of 5 1/2"
	Perkins 6357 6 Cil Diesel	●	01/79	12/89	<b>NKBA04554</b>	NKBR04554	Sem Polia / Sin Polea / Without Pulley
	Perkins 6358 6 Cil Diesel	●	01/79	12/89		NKBR04559	Sem Polia / Sin Polea / Without Pulley
F 12000	6BT59 6 Cil Diesel	●	01/76	11/86	<b>NKBA10731</b>		
	6BTA59 6 Cil Diesel	●	01/76	11/86	<b>NKBA10731</b>		
	6BTAA59 6 Cil Diesel	●	01/76	11/86	<b>NKBA10731</b>		
	MWM D229 6 Cil Diesel	●	01/80	12/90	<b>NKBA06576</b>		
	Perkins 6358 6 Cil Diesel	●	01/79	12/89		NKBR04559	Sem Polia / Sin Polea / Without Pulley
F 13000	MWM D229 6 Cil Diesel	●	01/80	12/90	<b>NKBA06576</b>		
	Perkins 6358 6 Cil Diesel	●	01/79	12/89		NKBR04559	Sem Polia / Sin Polea / Without Pulley
F 14000	6BT59 6 Cil Diesel	●	01/76	11/86	<b>NKBA10731</b>		
	6BTA59 6 Cil Diesel	●	01/76	11/86	<b>NKBA10731</b>		
	6BTAA59 6 Cil Diesel	●	01/76	11/86	<b>NKBA10731</b>		



**Caminhões & Ônibus / Camiones y Autobuses / Heavy Trucks & Buses**

**FORD**

F 14000	MWM D229 6 Cil Diesel	●	01/80	12/90	<b>NKBA06576</b>	
F 16000	6BT59 6 Cil Diesel	●	01/76	11/86	<b>NKBA10731</b>	
	6BTA59 6 Cil Diesel	●	01/76	11/86	<b>NKBA10731</b>	
	6BTAA59 6 Cil Diesel	●	01/76	11/86	<b>NKBA10731</b>	
F 19000	MWM D229 6 Cil Diesel	●	01/80	12/90	<b>NKBA06576</b>	
F 2000	MWM D229 4 Cil Diesel	●	01/80	12/90	<b>NKBA06576</b>	
F 21000	MWM D229 6 Cil Diesel	●	01/80	12/90	<b>NKBA06576</b>	
F 22000	MWM D229 6 Cil Diesel	●	01/80	12/90	<b>NKBA06576</b>	
F 250	4.2 Sprint Turbo 6 Cil Diesel	●	01/99	12/06	<b>NKBA06577</b>	Engrenagem 15° / Engranaje 15° / Gear 15°
	CUMMINS ISBE 3.9L 4 Cil Diesel	●	01/06	12/13	<b>NKBA10733</b>	Rotor de 82mm
F 4000	6BT59 6 Cil Diesel	●	01/76	11/86	<b>NKBA10731</b>	
	6BTA59 6 Cil Diesel	●	01/76	11/86	<b>NKBA10731</b>	
	6BTAA59 6 Cil Diesel	●	01/76	11/86	<b>NKBA10731</b>	
	Cummins 6BTA 5.9	●	01/76	11/86	<b>NKBA10731</b>	
	MWM D226 4 Cil Diesel	●	01/80	12/90	<b>NKBA06576</b>	Bosch/CAV / Bosch/CAV / Bosch/CAV
	MWM D229 4 Cil Diesel	●	01/80	12/90	<b>NKBA06576</b>	
	MWM Série 10		01/80	12/90	<b>NKBA06579</b>	
F 600	Diesel	●	01/69	12/81	<b>NKBA04553</b>	NKBR04554 Com Polia Simples de 5 1/2" / Con Polea Simple de 5 1/2" / With Single Pulley of 5 1/2"
	Diesel	●	01/69	12/81	<b>NKBA04554</b>	NKBR04554 Sem Polia / Sin Polea / Without Pulley
	MWM D225 Diesel	●	01/80	12/90	<b>NKBA06576</b>	
	MWM D229 Diesel	●	01/80	12/90	<b>NKBA06576</b>	
F 700	Perkins 6358 6 Cil Diesel	●	01/79	12/89		NKBR04559 Sem Polia / Sin Polea / Without Pulley
F 7000	Diesel	●	01/69	12/81	<b>NKBA04553</b>	NKBR04554 Com Polia Simples de 5 1/2" / Con Polea Simple de 5 1/2" / With Single Pulley of 5 1/2"
	Diesel	●	01/69	12/81	<b>NKBA04554</b>	NKBR04554 Sem Polia / Sin Polea / Without Pulley
F 75	BF 161 6 Cil Diesel	●	01/60	12/72	<b>NKBA02054</b>	
	Ford Pinto Diesel	●	01/73	12/83	<b>NKBA02092</b>	
F 750	Perkins 6358 6 Cil Diesel	●	01/79	12/89		NKBR04559 Sem Polia / Sin Polea / Without Pulley
FB 4000	MWM D229 4 Cil Diesel	●	01/80	12/90	<b>NKBA06576</b>	

**GENERAL MOTORS**

11000	Perkins 6.354 6 Cil Diesel	●	01/85	01/95	<b>NKBA04560</b>	NKBR04561 Sem Polia / Sin Polea / Without Pulley
	Perkins QB20B 6 Cil Diesel	●	01/85	01/95	<b>NKBA04560</b>	NKBR04561 Sem Polia / Sin Polea / Without Pulley
16220	Cummins 6CT 8.3 Diesel	●	01/80	12/90	<b>NKBA10732</b>	
22000	Perkins 6.354 6 Cil Diesel	●	01/85	01/95	<b>NKBA04560</b>	NKBR04561 Sem Polia / Sin Polea / Without Pulley
	Perkins QB20B 6 Cil Diesel	●	01/85	01/95	<b>NKBA04560</b>	NKBR04561 Sem Polia / Sin Polea / Without Pulley
6.150	MWM Sprint Todos Diesel	●	01/85	12/06	<b>NKBA06577</b>	Engrenagem 15° / Engranaje 15° / Gear 15°
A/C/D 40	Perkins QB20B 4 Cil Diesel	●	01/84	12/92	<b>NKBA04332</b>	NKBR07391 Sem Polia / Sin Polea / Without Pulley
A/C/D 60	261 6 Cil Diesel	●	01/60	12/81	<b>NKBA03128</b>	NKBR03759
	Perkins 6.354 6 Cil Diesel	●	01/85	12/95	<b>NKBA04560</b>	NKBR04561 Sem Polia / Sin Polea / Without Pulley
	Perkins 6.357 6 Cil Diesel	●	01/69	12/80	<b>NKBA04553</b>	NKBR04554 Com Polia Simples de 5 1/2" / Con Polea Simple de 5 1/2" / With Single Pulley of 5 1/2"
	Perkins 6.357 6 Cil Diesel	●	01/69	12/80	<b>NKBA04554</b>	NKBR04554 Sem Polia / Sin Polea / Without Pulley

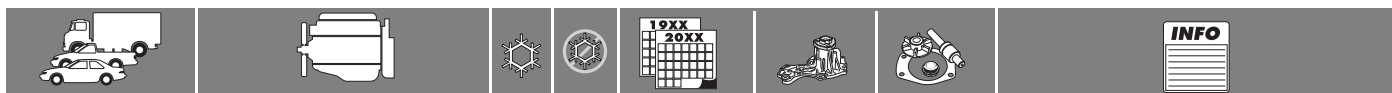

**Caminhões & Ônibus / Camiones y Autobuses / Heavy Trucks & Buses**

**GENERAL MOTORS**

A/C/D 60	Perkins 6.358 6 Cil Diesel	●	01/81	12/84	NKBR04559	Sem Polia / Sin Polea / Without Pulley
	Perkins QB20B 6 Cil Diesel	●	01/85	12/95	<b>NKBA04560</b>	NKBR04561 Sem Polia / Sin Polea / Without Pulley
A/C/D 70	Perkins 6.354 6 Cil Diesel	●	01/85	12/95	<b>NKBA04560</b>	NKBR04561 Sem Polia / Sin Polea / Without Pulley
	Perkins 6.357 6 Cil Diesel	●	01/69	12/80	<b>NKBA04554</b>	NKBR04554 Sem Polia / Sin Polea / Without Pulley
	Perkins 6.358 6 Cil Diesel	●	01/81	12/84	NKBR04559	Sem Polia / Sin Polea / Without Pulley
	Perkins QB20B 6 Cil Diesel	●	01/85	12/95	<b>NKBA04560</b>	NKBR04561 Sem Polia / Sin Polea / Without Pulley
A/C/D 80	Perkins 6.354 6 Cil Diesel	●	01/85	12/95	<b>NKBA04560</b>	NKBR04561 Sem Polia / Sin Polea / Without Pulley
	Perkins 6.358 6 Cil Diesel	●	01/81	12/84	NKBR04559	Sem Polia / Sin Polea / Without Pulley
	Perkins QB20B 6 Cil Diesel	●	01/85	12/95	<b>NKBA04560</b>	NKBR04561 Sem Polia / Sin Polea / Without Pulley
A/C/D 90	Perkins 6.354 6 Cil Diesel	●	01/85	12/95	<b>NKBA04560</b>	NKBR04561 Sem Polia / Sin Polea / Without Pulley
	Perkins QB20B 6 Cil Diesel	●	01/85	12/95	<b>NKBA04560</b>	NKBR04561 Sem Polia / Sin Polea / Without Pulley

**IVECO**

Daily 35.10	Motor 8140.23 4 Cil Diesel	●	01/01	06/08	NKBR14202	
Daily 40.12	Motor 8140.43 4 Cil Diesel	●	01/01	06/08	NKBR14202	
Daily 49.12	Motor 8140.43 4 Cil Diesel	●	01/01	06/08	NKBR14202	
Daily 59.12	Motor 8140.43 4 Cil Diesel	●	01/01	06/08	NKBR14202	
Eurocargo	FPT 6 Cil Diesel	●	01/03	12/09	<b>NKBA10733</b>	Rotor de 82mm
	Motor 8060.25R 4 Cil Diesel	●	01/92	06/08	NKBR14200	
	Motor 8060.45A 4 Cil Diesel	●	01/98	06/08	NKBR14200	
Tector	CUMMINS ISBE	●	01/09	06/12	<b>NKBA10733</b>	Rotor de 82mm

**MARCOPOLO**

Volare A5	MWM 4.07 TCA 4 Cil Diesel	●	01/01	06/05	<b>NKBA06575</b>	Engrenagem 3° / Engranaje 3° / Gear 3°
Volare A6	MWM 4.07 TCA 4 Cil Diesel	●	01/01	06/05	<b>NKBA06575</b>	Engrenagem 3° / Engranaje 3° / Gear 3°

**MERCEDES BENZ**

1016 Accelo	OM924LA		01/12	12/17	<b>NKBA05380</b>	NKBR051375
1111	OM 352 6 Cil Diesel	●	01/69	12/70	<b>NKBA05314</b>	NKBR051313 Sem Tampa / Sin la Cubierta / Without Cover
1113	OM 352 6 Cil Diesel	●	01/69	12/70	<b>NKBA05314</b>	NKBR051313 Sem Tampa / Sin la Cubierta / Without Cover
	OM 352 6 Cil Diesel	●	01/74	12/89	<b>NKBA05362</b>	NKBR05608 Rebaixado sem Tampa, Rotor com Diam. 87,5 mm. / Rebajado sin la Cubierta, el Rotor con Diam. 87.5 mm. / Lowered without Cover, Rotor with Diam. 87,5 mm.
	OM 352A 6 Cil Diesel	●	01/74	12/89	<b>NKBA05366</b>	NKBR051364 Rebaixado sem Tampa, Rotor com Diam. 95 mm. / Rebajado sin la Cubierta, el Rotor con Diam. 95 mm. / Lowered without Cover, Rotor with Diam. 95 mm.
	OM 352A 6 Cil Diesel	●	01/86	12/89	<b>NKBA05316</b>	NKBR051315 Sem Tampa, Rotor Diam. 95 mm / Sin la Cubierta, Rotor de Diam. 95 mm / Without Cover, Diam Rotor. 95 mm
1116	OM 352 6 Cil Diesel	●	01/69	12/70	<b>NKBA05314</b>	NKBR051313 Sem Tampa / Sin la Cubierta / Without Cover
	OM 352A 6 Cil Diesel	●	01/86	12/89	<b>NKBA05316</b>	NKBR051315 Sem Tampa, Rotor Diam. 95 mm / Sin la Cubierta, Rotor de Diam. 95 mm / Without Cover, Diam Rotor. 95 mm
1214	OM 366/366A 6 Cil Diesel	●	01/89	12/99	<b>NKBA05366</b>	NKBR051364 Sem Tampa Traseira / Sin la Cubierta trazera / Without Back Cover
1215	OM 904LA 4 Cil Diesel	●	01/98	12/06	<b>NKBA05380</b>	NKBR051375





**Caminhões & Ônibus / Camiones y Autobuses / Heavy Trucks & Buses**

**MERCEDES BENZ**

1218	OM 366/366A 6 Cil Diesel	●	01/89	12/99	<b>NKBA05366</b>	NKBR051364	Sem Tampa Traseira / Sin la Cubierta trazera / Without Back Cover
	OM 904LA 4 Cil Diesel	●	01/98	12/06	<b>NKBA05380</b>	NKBR051375	
1313	OM 352 6 Cil Diesel	●	01/69	12/70	<b>NKBA05314</b>	NKBR051313	Sem Tampa / Sin la Cubierta / Without Cover
	OM 352A 6 Cil Diesel	●	01/86	12/89	<b>NKBA05316</b>	NKBR051315	Sem Tampa, Rotor Diam. 95 mm / Sin la Cubierta, Rotor de Diam. 95 mm / Without Cover, Diam Rotor. 95 mm
1315	OM 366/366A 6 Cil Diesel	●	01/89	12/96	<b>NKBA05366</b>	NKBR051364	Sem Tampa Traseira / Sin la Cubierta trazera / Without Back Cover
1316	OM 352 6 Cil Diesel	●	01/69	12/70	<b>NKBA05314</b>	NKBR051313	Sem Tampa / Sin la Cubierta / Without Cover
	OM 352A 6 Cil Diesel	●	01/86	12/89	<b>NKBA05316</b>	NKBR051315	Sem Tampa, Rotor Diam. 95 mm / Sin la Cubierta, Rotor de Diam. 95 mm / Without Cover, Diam Rotor. 95 mm
1318	OM 366/366A 6 Cil Diesel	●	01/89	12/99	<b>NKBA05366</b>	NKBR051364	Sem Tampa Traseira / Sin la Cubierta trazera / Without Back Cover
1319 Atron	OM924LA		01/12	12/17	<b>NKBA05380</b>	NKBR051375	
1414	OM 366/366A 6 Cil Diesel	●	01/89	12/99	<b>NKBA05366</b>	NKBR051364	Sem Tampa Traseira / Sin la Cubierta trazera / Without Back Cover
1418	OM 366/366A 6 Cil Diesel	●	01/89	12/99	<b>NKBA05366</b>	NKBR051364	Sem Tampa Traseira / Sin la Cubierta trazera / Without Back Cover
	OM 904LA 4 Cil Diesel	●	01/98	12/06	<b>NKBA05380</b>	NKBR051375	
1419 Atego	OM924LA		01/12	12/17	<b>NKBA05380</b>	NKBR051375	
1513	OM 352 6 Cil Diesel	●	01/69	12/70	<b>NKBA05314</b>	NKBR051313	Sem Tampa / Sin la Cubierta / Without Cover
	OM 352A 6 Cil Diesel	●	01/86	12/89	<b>NKBA05316</b>	NKBR051315	Sem Tampa, Rotor Diam. 95 mm / Sin la Cubierta, Rotor de Diam. 95 mm / Without Cover, Diam Rotor. 95 mm
1516	OM 352 6 Cil Diesel	●	01/69	12/70	<b>NKBA05314</b>	NKBR051313	Sem Tampa / Sin la Cubierta / Without Cover
	OM 352A 6 Cil Diesel	●	01/86	12/89	<b>NKBA05316</b>	NKBR051315	Sem Tampa, Rotor Diam. 95 mm / Sin la Cubierta, Rotor de Diam. 95 mm / Without Cover, Diam Rotor. 95 mm
1517	CUMMINS ISBE 3.9L 4 Cil Diesel	●	01/11	12/14	<b>NKBA10733</b>		Rotor de 82mm
	OM 355 5/6 Cil Diesel	●	01/79	12/92	<b>NKBA05355</b>	NKBR051356	Rotor 115 mm / Rotor 115 mm / Rotor 115 mm
1519	OM 355 5/6 Cil Diesel	●	01/79	12/92	<b>NKBA05355</b>	NKBR051356	Rotor 115 mm / Rotor 115 mm / Rotor 115 mm
1614	OM 366/366A 6 Cil Diesel	●	01/89	12/99	<b>NKBA05366</b>	NKBR051364	Sem Tampa Traseira / Sin la Cubierta trazera / Without Back Cover
1618	OM 366/366A 6 Cil Diesel	●	01/89	12/99	<b>NKBA05366</b>	NKBR051364	Sem Tampa Traseira / Sin la Cubierta trazera / Without Back Cover
1620	OM 366/366A 6 Cil Diesel	●	01/89	12/99	<b>NKBA05366</b>	NKBR051364	Sem Tampa Traseira / Sin la Cubierta trazera / Without Back Cover
1621	OM 366/366A 6 Cil Diesel	●	01/89	12/99	<b>NKBA05366</b>	NKBR051364	Sem Tampa Traseira / Sin la Cubierta trazera / Without Back Cover
1622	OM 924LA 4 Cil Diesel	●	01/98	12/06	<b>NKBA05380</b>	NKBR051375	
1714	OM 366/366A 6 Cil Diesel	●	01/89	12/99	<b>NKBA05366</b>	NKBR051364	Sem Tampa Traseira / Sin la Cubierta trazera / Without Back Cover
1718	OM 366/366A 6 Cil Diesel	●	01/89	12/99	<b>NKBA05366</b>	NKBR051364	Sem Tampa Traseira / Sin la Cubierta trazera / Without Back Cover
	OM 904LA 4 Cil Diesel	●	01/98	12/07	<b>NKBA05380</b>	NKBR051375	
1719 Atego	OM924LA		01/12	12/17	<b>NKBA05380</b>	NKBR051375	

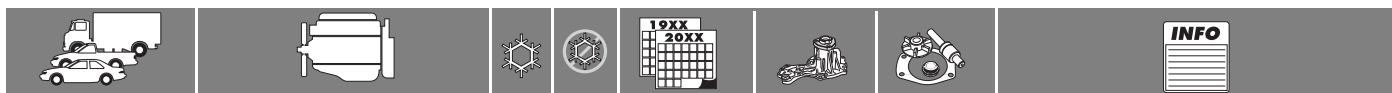

**Caminhões & Ônibus / Camiones y Autobuses / Heavy Trucks & Buses**

**MERCEDES BENZ**

1721	OM 366/366A 6 Cil Diesel	●	01/89	12/99	<b>NKBA05366</b>	NKBR051364	Sem Tampa Traseira / Sin la Cubierta trazera / Without Back Cover
1726 Atego	OM 926 LA		01/12	12/17	<b>NKBA05381</b>		
1924	OM 355 Turbo 5/6 Cil Diesel	●	01/80	12/92		NKBR051358	Rotor com Diam. 120,5 mm / Rotor con Diam. 120.5 mm / Rotor with Diam. 120,5 mm
1929	OM 355 Turbo 5/6 Cil Diesel	●	01/80	12/92		NKBR051358	Rotor com Diam. 120,5 mm / Rotor con Diam. 120.5 mm / Rotor with Diam. 120,5 mm
1933S	OM 926LA 6 Cil Diesel	●	01/03	12/08	<b>NKBA05381</b>		
1935	OM 447LA 6 Cil Diesel	●	01/90	12/06	<b>NKBA05372</b>	NKBR051373	Com Rotor de 136 mm / Con Rotor de 136 mm / With 136 mm Rotor
1938	OM 457 6 Cil Diesel	●	01/90	12/06	<b>NKBA05373</b>	NKBR051374	Com Rotor de 125 mm / Con Rotor de 125 mm / With 125 mm Rotor
	OM 457 Eletrônico 6 Cil Diesel	●	01/90	12/06	<b>NKBA05374</b>	NKBR051374	Com Rotor de 125 mm / Con Rotor de 125 mm / With 125 mm Rotor
1938S	OM 457LA 6 Cil Diesel	●	01/05	12/08	<b>NKBA05375</b>		
	OM 460LA 6 Cil Diesel	●	01/05	12/08	<b>NKBA05375</b>		
1941	OM 447LA 6 Cil Diesel	●	01/90	12/06	<b>NKBA05372</b>	NKBR051373	Com Rotor de 136 mm / Con Rotor de 136 mm / With 136 mm Rotor
1944	OM 457LA 6 Cil Diesel	●	01/02	06/08	<b>NKBA05374</b>	NKBR051374	Com Rotor de 125 mm / Con Rotor de 125 mm / With 125 mm Rotor
1944S	OM 457LA 6 Cil Diesel	●	01/05	12/08	<b>NKBA05375</b>		
	OM 460LA 6 Cil Diesel	●	01/05	12/08	<b>NKBA05375</b>		
2013	OM 352 6 Cil Diesel	●	01/69	12/70	<b>NKBA05314</b>	NKBR051313	Sem Tampa / Sin la Cubierta / Without Cover
	OM 352A 6 Cil Diesel	●	01/86	12/89	<b>NKBA05316</b>	NKBR051315	Sem Tampa, Rotor Diam. 95 mm / Sin la Cubierta, Rotor de Diam. 95 mm / Without Cover, Diam Rotor. 95 mm
2016	OM 352 6 Cil Diesel	●	01/69	12/70	<b>NKBA05314</b>	NKBR051313	Sem Tampa / Sin la Cubierta / Without Cover
	OM 352A 6 Cil Diesel	●	01/86	12/89	<b>NKBA05316</b>	NKBR051315	Sem Tampa, Rotor Diam. 95 mm / Sin la Cubierta, Rotor de Diam. 95 mm / Without Cover, Diam Rotor. 95 mm
2213	OM 352 6 Cil Diesel	●	01/69	12/70	<b>NKBA05314</b>	NKBR051313	Sem Tampa / Sin la Cubierta / Without Cover
	OM 352A 6 Cil Diesel	●	01/86	12/89	<b>NKBA05316</b>	NKBR051315	Sem Tampa, Rotor Diam. 95 mm / Sin la Cubierta, Rotor de Diam. 95 mm / Without Cover, Diam Rotor. 95 mm
2216	OM 352 6 Cil Diesel	●	01/69	12/70	<b>NKBA05314</b>	NKBR051313	Sem Tampa / Sin la Cubierta / Without Cover
	OM 352A 6 Cil Diesel	●	01/86	12/89	<b>NKBA05316</b>	NKBR051315	Sem Tampa, Rotor Diam. 95 mm / Sin la Cubierta, Rotor de Diam. 95 mm / Without Cover, Diam Rotor. 95 mm
2219	OM 355 5/6 Cil Diesel	●	01/79	12/92	<b>NKBA05355</b>	NKBR051356	Rotor 115 mm / Rotor 115 mm / Rotor 115 mm
2314	OM 366/366A 6 Cil Diesel	●	01/89	12/99	<b>NKBA05366</b>	NKBR051364	Sem Tampa Traseira / Sin la Cubierta trazera / Without Back Cover
2318	OM 366/366A 6 Cil Diesel	●	01/89	12/99	<b>NKBA05366</b>	NKBR051364	Sem Tampa Traseira / Sin la Cubierta trazera / Without Back Cover
2324 Atron	OM 926 LA		01/12	12/17	<b>NKBA05381</b>		
2418	OM 366/366A 6 Cil Diesel	●	01/89	12/99	<b>NKBA05366</b>	NKBR051364	Sem Tampa Traseira / Sin la Cubierta trazera / Without Back Cover
2423	OM 904LA 4 Cil Diesel	●	01/98	12/06	<b>NKBA05380</b>	NKBR051375	
2426 Atego	OM 926 LA		01/12	12/17	<b>NKBA05381</b>		



**Caminhões & Ônibus / Camiones y Autobuses / Heavy Trucks & Buses**

**MERCEDES BENZ**

2428	OM 906LA 6 Cil Diesel	●	01/98	12/06	<b>NKBA05380</b>	NKBR051375	
2429 Atego	OM 926 LA		01/12	12/17	<b>NKBA05381</b>		
2533	OM 926LA 6 Cil Diesel	●	01/03	12/08	<b>NKBA05381</b>		
2533 Axor	OM 926 LA		01/12	12/17	<b>NKBA05381</b>		
2638	OM 457 LA 6 Cil Diesel	●	01/01	06/08	<b>NKBA05374</b>	NKBR051374	Com Rotor de 125 mm / Con Rotor de 125 mm / With 125 mm Rotor
2729 Atron	OM 926 LA		01/12	12/17	<b>NKBA05381</b>		
2831 Axor	OM 926 LA		01/12	12/17	<b>NKBA05381</b>		
608	OM 314 4 Cil Diesel	●	01/72	12/90	<b>NKBA05608</b>	NKBR05608	
709	OM 364 4 Cil Diesel	●	01/90	01/95	<b>NKBA05609</b>		Com rolamento reforçado
	OM 364 4 Cil Diesel	●	01/90	01/95	<b>NKBA05610</b>	NKBR05709	Exceto motor eletrônico
712	OM 364A 4 Cil Diesel	●	01/90	01/95	<b>NKBA05609</b>		Com rolamento reforçado
	OM 364A 4 Cil Diesel	●	01/90	01/95	<b>NKBA05610</b>	NKBR05709	Exceto motor eletrônico
	OM 904LA 4 Cil Diesel	●	01/98	12/06	<b>NKBA05380</b>	NKBR051375	
809	OM 364 4 Cil Diesel	●	01/90	12/98	<b>NKBA05609</b>		Com rolamento reforçado
	OM 364 4 Cil Diesel	●	01/90	12/98	<b>NKBA05610</b>	NKBR05709	Exceto motor eletrônico
812	OM 364 4 Cil Diesel	●	01/90	12/98	<b>NKBA05609</b>		Com rolamento reforçado
	OM 364 4 Cil Diesel	●	01/90	12/98	<b>NKBA05610</b>	NKBR05709	Exceto motor eletrônico
	OM 364A 4 Cil Diesel	●	01/90	01/95	<b>NKBA05609</b>		Com rolamento reforçado
	OM 364A 4 Cil Diesel	●	01/90	01/95	<b>NKBA05610</b>	NKBR05709	Exceto motor eletrônico
815 Accelo	OM924LA		01/12	12/17	<b>NKBA05380</b>	NKBR051375	
912	OM 364A 4 Cil Diesel	●	01/90	12/06	<b>NKBA05609</b>		Com rolamento reforçado
	OM 364A 4 Cil Diesel	●	01/90	12/06	<b>NKBA05610</b>	NKBR05709	Exceto motor eletrônico
914	OM 364A 4 Cil Diesel	●	01/81	12/06	<b>NKBA05609</b>		Com rolamento reforçado
	OM 364A 4 Cil Diesel	●	01/81	12/06	<b>NKBA05610</b>	NKBR05709	Exceto motor eletrônico
	OM 904LA 4 Cil Diesel	●	01/98	12/06	<b>NKBA05380</b>	NKBR051375	
LO914	OM 904LA 4 Cil Diesel	●	01/98	12/06	<b>NKBA05380</b>	NKBR051375	
LO916	OM924LA		01/12	12/17	<b>NKBA05380</b>	NKBR051375	
O352	OM 352 6 Cil Diesel	●	01/70	12/89	<b>NKBA05314</b>	NKBR051313	Sem Tampa / Sin la Cubierta / Without Cover
	OM 352A 6 Cil Diesel	●	01/86	12/89	<b>NKBA05316</b>	NKBR051315	Sem Tampa, Rotor Diam. 95 mm / Sin la Cubierta, Rotor de Diam. 95 mm / Without Cover, Diam Rotor. 95 mm
O355	OM 355 5/6 Cil Diesel	●	01/80	12/92		NKBR051358	Rotor com Diam. 120,5 mm / Rotor con Diam. 120,5 mm / Rotor with Diam. 120,5 mm
O362	OM 352 6 Cil Diesel	●	01/74	12/89	<b>NKBA05362</b>	NKBR05608	Rebaixado sem Tampa, Rotor com Diam. 87,5 mm. / Rebajado sin la Cubierta, el Rotor con Diam. 87,5 mm. / Lowered without Cover, Rotor with Diam. 87,5 mm.
	OM 352A 6 Cil Diesel	●	01/74	12/89	<b>NKBA05366</b>	NKBR051364	Rebaixado sem Tampa, Rotor com Diam. 95 mm. / Rebajado sin la Cubierta, el Rotor con Diam. 95 mm. / Lowered without Cover, Rotor with Diam. 95 mm.
O364	OM 352 5/6 Cil Diesel	●	01/82	12/89	<b>NKBA05362</b>	NKBR05608	Rebaixado sem Tampa, Rotor com Diam. 87,5 mm. / Rebajado sin la Cubierta, el Rotor con Diam. 87,5 mm. / Lowered without Cover, Rotor with Diam. 87,5 mm.

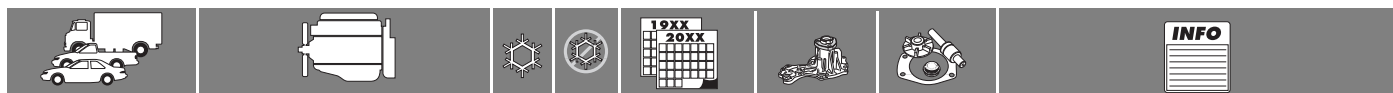

**Caminhões & Ônibus / Camiones y Autobuses / Heavy Trucks & Buses**

**MERCEDES BENZ**

O364	OM 352A 5/6 Cil Diesel	●	01/82	12/89	<b>NKBA05366</b>	NKBR051364	Rebaixado sem Tampa, Rotor com Diam. 95 mm. / Rebajado sin la Cubierta, el Rotor con Diam. 95 mm. / Lowered without Cover, Rotor with Diam. 95 mm.
	OM 355 5/6 Cil Diesel	●	01/80	12/92		NKBR051358	Rotor com Diam. 120,5 mm / Rotor con Diam. 120,5 mm / Rotor with Diam. 120,5 mm
	OM 355 5/6 Cil Diesel	●	01/80	12/92	<b>NKBA05355</b>	NKBR051356	
O371	OM 366/366A 6 Cil Diesel	●	01/89	12/99	<b>NKBA05366</b>	NKBR051364	Sem Tampa Traseira / Sin la Cubierta trazera / Without Back Cover
O400	OM-447 6 Cil Diesel		01/95	12/05	<b>NKBA05372</b>		
	OM-457 6 Cil Diesel		01/95	12/05	<b>NKBA05373</b>	NKBR051373	
	OM-457 6 Cil Diesel		01/95	12/05	<b>NKBA05374</b>	NKBR051374	Com Rotor de 125 mm / Con Rotor de 125 mm / With 125 mm Rotor
O500	OM 906 LA		01/98	06/15	<b>NKBA05380</b>	NKBR051375	
	OM 906 LA 6 Cil Diesel	●	01/98	12/06	<b>NKBA05380</b>	NKBR051375	
	OM 906LA 6 Cil Diesel	●	01/98	12/16	<b>NKBA05380</b>	NKBR051375	
	OM 926 LA		01/98	06/15	<b>NKBA05381</b>		
	OM 926 LA 6 Cil Diesel	●	01/03	12/08	<b>NKBA05381</b>		
	OM457LA		01/98	06/15	<b>NKBA05374</b>	NKBR051374	
O500M	OM 926 LA		01/12	12/17	<b>NKBA05381</b>		
O500U	OM 926 LA		01/12	12/17	<b>NKBA05381</b>		
OF1113	OM 352 6 Cil Diesel	●	01/82	12/89	<b>NKBA05362</b>	NKBR05608	Rebaixado sem Tampa, Rotor com Diam. 87,5 mm. / Rebajado sin la Cubierta, el Rotor con Diam. 87.5 mm. / Lowered without Cover, Rotor with Diam. 87,5 mm.
	OM 352A 6 Cil Diesel	●	01/82	12/89	<b>NKBA05366</b>	NKBR051364	Rebaixado sem Tampa, Rotor com Diam. 95 mm. / Rebajado sin la Cubierta, el Rotor con Diam. 95 mm. / Lowered without Cover, Rotor with Diam. 95 mm.
OF1115	OM 366/366A 6 Cil Diesel	●	01/89	12/99	<b>NKBA05366</b>	NKBR051364	Sem Tampa Traseira / Sin la Cubierta trazera / Without Back Cover
OF1313	OM 352 6 Cil Diesel	●	01/74	12/89	<b>NKBA05362</b>	NKBR05608	Rebaixado sem Tampa, Rotor com Diam. 87,5 mm. / Rebajado sin la Cubierta, el Rotor con Diam. 87.5 mm. / Lowered without Cover, Rotor with Diam. 87,5 mm.
	OM 352A 6 Cil Diesel	●	01/74	12/89	<b>NKBA05366</b>	NKBR051364	Rebaixado sem Tampa, Rotor com Diam. 95 mm. / Rebajado sin la Cubierta, el Rotor con Diam. 95 mm. / Lowered without Cover, Rotor with Diam. 95 mm.
	OM 366/366A 6 Cil Diesel	●	01/89	12/99	<b>NKBA05366</b>	NKBR051364	Sem Tampa Traseira / Sin la Cubierta trazera / Without Back Cover
OF1318	OM 366/366A 6 Cil Diesel	●	01/89	12/99	<b>NKBA05366</b>	NKBR051364	Sem Tampa Traseira / Sin la Cubierta trazera / Without Back Cover
OF1417	OM904 Diesel	●	01/01	12/06	<b>NKBA05380</b>	NKBR051375	
OF1418	OM904		06/06	12/14	<b>NKBA05380</b>	NKBR051375	
OF1519	OM924LA		01/12	12/17	<b>NKBA05380</b>	NKBR051375	
OF1721	OM 366 Ecológico 6 Cil Diesel	●	01/80	12/90	<b>NKBA05369</b>	NKBR051372	Com Tampa / Con la Cubierta / With Cover
	OM366LA Diesel	●	06/12	12/16	<b>NKBA05369</b>	NKBR051372	
	OM924LA		01/12	12/17	<b>NKBA05380</b>	NKBR051375	
OF1722	OM904 Diesel	●	01/01	12/06	<b>NKBA05380</b>	NKBR051375	Câmbio ALLISON MT 643R / Cambio ALLISON MT 643R / Gear ALLISON MT 643R

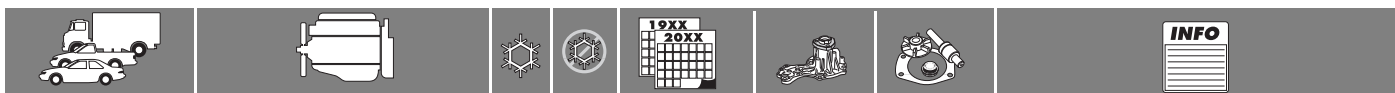

**Caminhões & Ônibus / Camiones y Autobuses / Heavy Trucks & Buses**

**MERCEDES BENZ**

OF1724	OM 926 LA		01/12	12/17	<b>NKBA05381</b>		
OH1313	OM 352 6 Cil Diesel	●	01/82	12/89	<b>NKBA05362</b>	NKBR05608	Rebaixado sem Tampa, Rotor com Diam. 87,5 mm. / Rebajado sin la Cubierta, el Rotor con Diam. 87.5 mm. / Lowered without Cover, Rotor with Diam. 87,5 mm.
	OM 352A 6 Cil Diesel	●	01/82	12/89	<b>NKBA05366</b>	NKBR051364	Rebaixado com Tampa, Rotor com Diam. 95 mm. / Rebajado con la Cubierta, el Rotor con Diam. 95 mm. / Lowered with Cover, Rotor with Diam. 95 mm.
OH1316	OM 352 6 Cil Diesel	●	01/82	12/89	<b>NKBA05362</b>	NKBR05608	Rebaixado sem Tampa, Rotor com Diam. 87,5 mm. / Rebajado sin la Cubierta, el Rotor con Diam. 87.5 mm. / Lowered without Cover, Rotor with Diam. 87,5 mm.
	OM 352A 6 Cil Diesel	●	01/82	12/89	<b>NKBA05366</b>	NKBR051364	Rebaixado sem Tampa, Rotor com Diam. 95 mm. / Rebajado sin la Cubierta, el Rotor con Diam. 95 mm. / Lowered without Cover, Rotor with Diam. 95 mm.
OH1317	OM 366/366A 6 Cil Diesel	●	01/89	12/99	<b>NKBA05366</b>	NKBR051364	Sem Tampa Traseira / Sin la Cubierta trazera / Without Back Cover
OH1419	OM 355 5/6 Cil Diesel	●	01/79	12/92	<b>NKBA05355</b>	NKBR051356	Rotor 115 mm / Rotor 115 mm / Rotor 115 mm
OH1519	OM924LA		01/12	12/17	<b>NKBA05380</b>	NKBR051375	

**SCANIA**

F250	DC09	●	01/12	12/17	<b>NKBA11981</b>		rotor com diâmetro de 112mm
F310	DC09	●	01/12	12/17	<b>NKBA11981</b>		rotor com diâmetro de 112mm
K112	Diesel	●	01/83	12/93	<b>NKBA11984</b>	NKBR11985	
K124	DSC12	●	01/98	12/04	<b>NKBA11980</b>		rotor com diâmetro de 105mm
	DSC12	●	01/05	12/09	<b>NKBA11981</b>		rotor com diâmetro de 112mm
K250	DC09	●	01/12	12/17	<b>NKBA11981</b>		rotor com diâmetro de 112mm
K310	DC09	●	01/12	12/17	<b>NKBA11981</b>		rotor com diâmetro de 112mm
	DSC09		01/99	12/14	<b>NKBA11981</b>		
K340	DSC09		12/08	12/14	<b>NKBA11981</b>		
K380	DSC12		01/05	12/14	<b>NKBA11981</b>		Eixo Intermediário / Eje intermedio / Intermediate shaft
L111	Diesel	●	01/75	12/76	<b>NKBA11982</b>	NKBR11983	Com Filtro Dentro / Con el Filtro Adentro / With Filter Inside
LS111	Diesel	●	01/75	12/76	<b>NKBA11982</b>	NKBR11983	Com Filtro Dentro / Con el Filtro Adentro / With Filter Inside
LT111	Diesel	●	01/75	12/76	<b>NKBA11982</b>	NKBR11983	Com Filtro Dentro / Con el Filtro Adentro / With Filter Inside
P114	DSC 11	●	01/98	12/04	<b>NKBA11980</b>		rotor com diâmetro de 105mm
	DSC 12	●	01/05	12/09	<b>NKBA11981</b>		rotor com diâmetro de 112mm
P250	DC09	●	01/12	12/17	<b>NKBA11981</b>		rotor com diâmetro de 112mm
P270	DC09	●	01/12	12/17	<b>NKBA11981</b>		rotor com diâmetro de 112mm
P310	DC09	●	01/12	12/17	<b>NKBA11981</b>		rotor com diâmetro de 112mm
R114	DSC 11	●	01/98	12/04	<b>NKBA11980</b>		rotor com diâmetro de 105mm
	DSC 12	●	01/05	12/09	<b>NKBA11981</b>		rotor com diâmetro de 112mm
R124	DSC 11	●	01/98	12/04	<b>NKBA11980</b>		rotor com diâmetro de 105mm

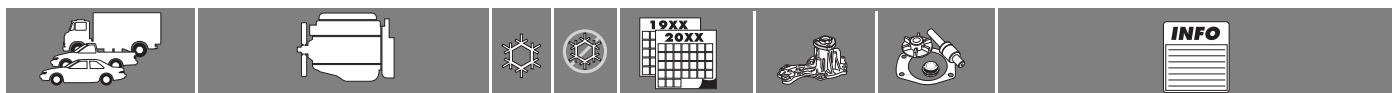

**Caminhões & Ônibus / Camiones y Autobuses / Heavy Trucks & Buses**

**SCANIA**

R124	DSC 12	●	01/05	12/09	<b>NKBA11981</b>		rotor com diâmetro de 112mm
S112	Diesel	●	01/83	12/93	<b>NKBA11984</b>	NKBR11985	
T112	Diesel	●	01/83	12/93	<b>NKBA11984</b>	NKBR11985	
T114	DSC 11	●	01/98	12/04	<b>NKBA11980</b>		rotor com diâmetro de 105mm
	DSC 12	●	01/05	12/09	<b>NKBA11981</b>		rotor com diâmetro de 112mm
T124	DSC 11	●	01/98	12/04	<b>NKBA11980</b>		rotor com diâmetro de 105mm
	DSC 12	●	01/05	12/09	<b>NKBA11981</b>		rotor com diâmetro de 112mm

**VOLARE**

W8	4.12TCE 4 Cil Diesel	●	05/05	12/07	<b>NKBA06573</b>		Engrenagem com dentes retos
W9	4.12TCE 4 Cil Diesel	●	05/05	12/07	<b>NKBA06573</b>		Engrenagem com dentes retos

**VOLKSWAGEN - MA**

11-130	MWM D229 6 Cil Diesel	●	01/80	12/90	<b>NKBA06576</b>		
11-140	MWM D229 6 Cil Diesel	●	01/80	12/90	<b>NKBA06576</b>		
12-140	MWM D229 6 Cil Diesel	●	01/82	12/06	<b>NKBA06576</b>		
13-130	MWM D229 6 Cil Diesel	●	01/80	12/90	<b>NKBA06576</b>		
13-170	4.12TCE 4 Cil Diesel	●	05/05	12/07	<b>NKBA06573</b>		Engrenagem com dentes retos
	CUMMINS ISBE 3.9L 4 Cil Diesel	●	01/03	06/12	<b>NKBA10733</b>		Rotor de 82mm
13-180	CUMMINS ISBE 3.9L 4 Cil Diesel	●	01/03	06/12	<b>NKBA10733</b>		Rotor de 82mm
13-180 Worker	MWM 6.10TCA 4 Cil Diesel	●	05/05	12/07	<b>NKBA06573</b>		Engrenagem com dentes retos
14-150	MWM Série 10 Aspirado 6 Cil Diesel	●	01/80	12/90	<b>NKBA06579</b>		
14-200	MWM Série 10 Turbo 6 Cil Diesel	●	01/80	12/90	<b>NKBA06579</b>		
14-220	Cummins 6CT 8.3 Diesel	●	01/80	12/90	<b>NKBA10732</b>		
15-170	CUMMINS ISBE 3.9L 4 Cil Diesel	●	01/03	06/12	<b>NKBA10733</b>		Rotor de 82mm
15-170 Worker	4.12TCE 4 Cil Diesel	●	05/05	12/07	<b>NKBA06573</b>		Engrenagem com dentes retos
15-180	4.12TCE 4 Cil Diesel	●	05/05	12/07	<b>NKBA06573</b>		Engrenagem com dentes retos
	CUMMINS ISBE 3.9L 4 Cil Diesel	●	01/03	06/12	<b>NKBA10733</b>		Rotor de 82mm
15-190	4.12TCE 4 Cil Diesel	●	05/05	12/07	<b>NKBA06573</b>		Engrenagem com dentes retos
	CUMMINS ISBE 3.9L 4 Cil Diesel	●	01/03	06/12	<b>NKBA10733</b>		Rotor de 82mm
16-170	6BT-5.9 6 Cil Diesel	●	01/76	11/86	<b>NKBA10731</b>		
	6BTA-5.9 6 Cil Diesel	●	01/76	11/86	<b>NKBA10731</b>		
	6BTAA-5.9 6 Cil Diesel	●	01/76	11/86	<b>NKBA10731</b>		
16-180 CO	MWM Série 10 Turbo 6 Cil Diesel	●	01/80	12/90	<b>NKBA06579</b>		
17-210	MWM Série 10		01/00	12/06	<b>NKBA06579</b>		
17-230	MWM Série 12		01/07	12/14	<b>NKBA06573</b>		
17-240 EOT	MWM 6.12		01/04	12/10	<b>NKBA06573</b>		
17-250	CUMMINS ISBE 3.9L 4 Cil Diesel	●	01/03	06/12	<b>NKBA10733</b>		Rotor de 82mm
17-260 EOT	MWM 6.12		01/11	12/12	<b>NKBA06573</b>		
18-310 EOT	Cummins 6CT 8.3 Diesel	●	01/04	12/10	<b>NKBA10732</b>		
18-320	CUMMINS 8.3L 6CIL 6 Cil Diesel	●	01/06	12/12	<b>NKBA10734</b>		Rotor 105mm
18-320 EOT	CUMMINS ISCE 6 Cil Diesel	●	01/11	12/12	<b>NKBA10734</b>		Rotor 105mm



**Caminhões & Ônibus / Camiones y Autobuses / Heavy Trucks & Buses**

**VOLKSWAGEN - MA**

19-320	CUMMINS 8.3L 6CIL 6 Cil Diesel	●	01/06	12/12	<b>NKBA10734</b>	Rotor 105mm
20-250	CUMMINS ISBE 3.9L 4 Cil Diesel	●	01/03	06/12	<b>NKBA10733</b>	Rotor de 82mm
23-250	CUMMINS ISBE 3.9L 4 Cil Diesel	●	01/03	06/12	<b>NKBA10733</b>	Rotor de 82mm
24-220 Worker	Cummins 6CT 8.3 Diesel	●	01/80	12/90	<b>NKBA10732</b>	
24-250 Worker	Cummins 6CTAA 8.3 Diesel	●	01/80	12/90	<b>NKBA10732</b>	
25-320	CUMMINS 8.3L 6CIL 6 Cil Diesel	●	01/06	12/12	<b>NKBA10734</b>	Rotor 105mm
26-260 Worker	6.12TCE 6 Cil Diesel	●	12/05	12/07	<b>NKBA06573</b>	Engrenagem com dentes retos
	MWM 6.12TCE 6 Cil Diesel	●	02/02	10/07	<b>NKBA06573</b>	Engrenagem com dentes retos
31-260 Constellation	6.12TCE 6 Cil Diesel	●	12/05	12/07	<b>NKBA06573</b>	Engrenagem com dentes retos
31-320	CUMMINS 8.3L 6CIL 6 Cil Diesel	●	01/06	12/12	<b>NKBA10734</b>	Rotor 105mm
35-300	Cummins 6CTAA 8.3 Diesel	●	01/80	12/90	<b>NKBA10732</b>	
5-140	MWM 4.08 TCE 4 Cil Diesel	●	01/05	06/08	<b>NKBA06574</b>	Engrenagem 0° / Engranaje 0° / Gear 0°
6-80	Perkins 4236 4 Cil Diesel	●	01/82	12/85	<b>NKBA04326</b>	NKBR07391 Sem Polia / Sin Polea / Without Pulley
6-90	MWM D229 4 Cil Diesel	●	01/80	12/90	<b>NKBA06576</b>	
7-100	MWM Série 10 Aspirado 4 Cil Diesel	●	01/92	12/02	<b>NKBA06579</b>	
7-110 CO	MWM TD229 EC 4 Cil Diesel	●	01/80	12/90	<b>NKBA06578</b>	NKBR06575
7-90 CO	MWM D229 4 Cil Diesel	●	01/80	12/90	<b>NKBA06576</b>	
8-140	MWM Série 10 Turbo 4 Cil Diesel	●	01/80	12/90	<b>NKBA06579</b>	
8-150	CUMMINS ISBE 3.9L 4 Cil Diesel	●	01/03	06/12	<b>NKBA10733</b>	Rotor de 82mm
	MWM 4.08 TCE 4 Cil Diesel	●	01/05	06/08	<b>NKBA06574</b>	Engrenagem 0° / Engranaje 0° / Gear 0°
9-150	CUMMINS ISBE 3.9L 4 Cil Diesel	●	01/03	06/12	<b>NKBA10733</b>	Rotor de 82mm

**VOLVO**

B10	6 Cil Diesel	●	01/85	12/95	NKBR121100	Ônibus não articulado
B58	6 Cil Diesel	●	01/85	12/95	NKBR121100	Ônibus não articulado
VM 17210	6.12TCE 6 Cil Diesel	●	01/03	12/07	<b>NKBA06573</b>	Engrenagem com dentes retos
VM 17240	6.12TCE 6 Cil Diesel	●	01/03	12/07	<b>NKBA06573</b>	Engrenagem com dentes retos
VM 23210	6.12TCE 6 Cil Diesel	●	01/03	12/07	<b>NKBA06573</b>	Engrenagem com dentes retos
VM 23240	6.12TCE 6 Cil Diesel	●	01/03	12/07	<b>NKBA06573</b>	Engrenagem com dentes retos
VM 23310	6.12TCE 6 Cil Diesel	●	01/03	12/07	<b>NKBA06573</b>	Engrenagem com dentes retos
VM 26210	6.12TCE 6 Cil Diesel	●	01/03	12/07	<b>NKBA06573</b>	Engrenagem com dentes retos
VM 26260	6.12TCE 6 Cil Diesel	●	01/03	12/07	<b>NKBA06573</b>	Engrenagem com dentes retos

**Bomba d'água**



**NKBA01748**



**NKBA01749**

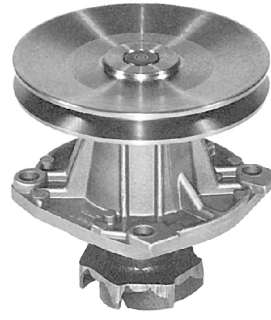

**NKBA01751**



**NKBA01752**



**NKBA01756**



**NKBA01757**



**NKBA01758**



**NKBA01761**



**NKBA01763**



**NKBA01764**

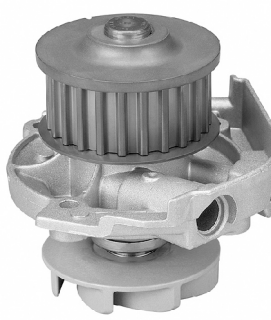

**NKBA01766**



**NKBA01767**



**NKBA01769**



**NKBA01771**

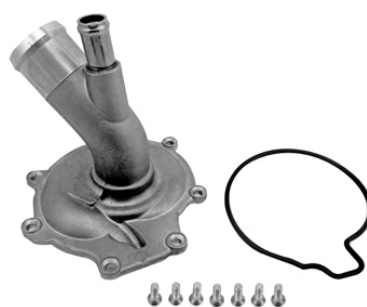

**NKBA01772**

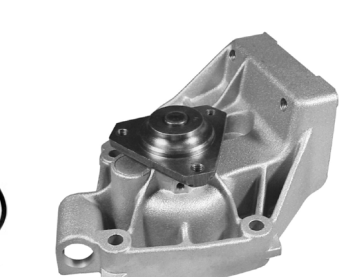

**NKBA01780**



**Bomba d'água**

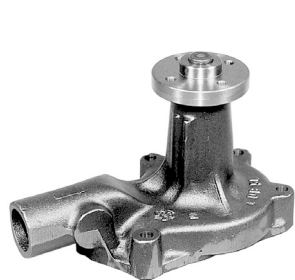

**NKBA02054**



**NKBA02092**



**NKBA02590**

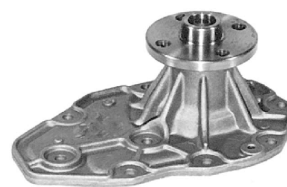

**NKBA02942**

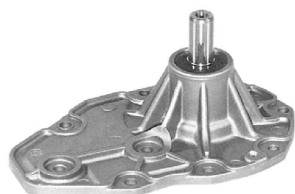

**NKBA02943**



**NKBA02944**



**NKBA02945**

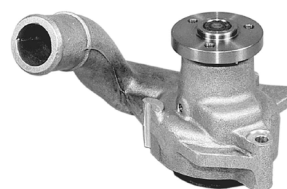

**NKBA02946**



**NKBA02947**

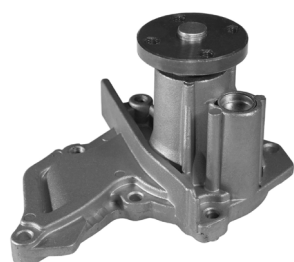

**NKBA02948**



**NKBA02950**



**NKBA02951**

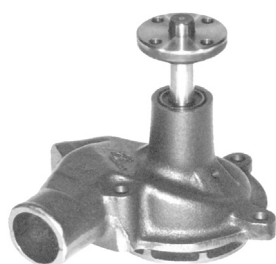

**NKBA03128**



**NKBA03132**



**NKBA03135**

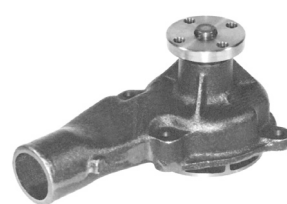

**NKBA03140**

**Bomba d'água**

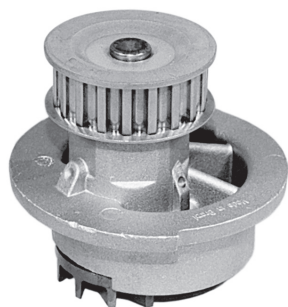

**NKBA03147**

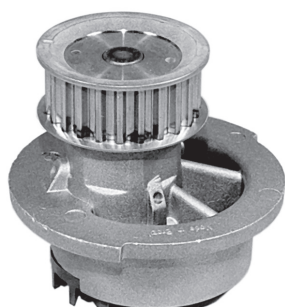

**NKBA03148**

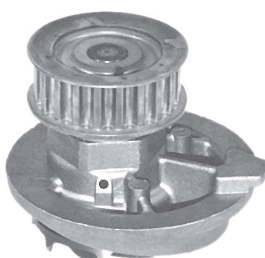

**NKBA03149**

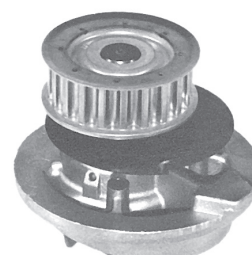

**NKBA03150**

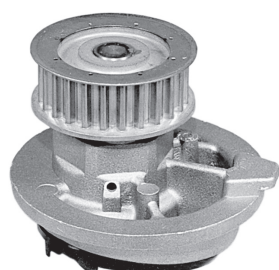

**NKBA03152**

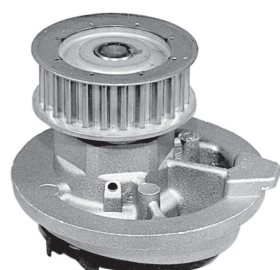

**NKBA03157**



**NKBA03160**

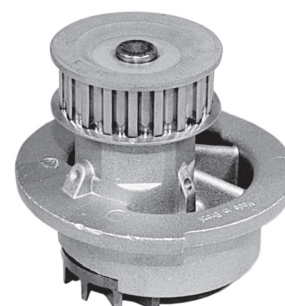

**NKBA03162**

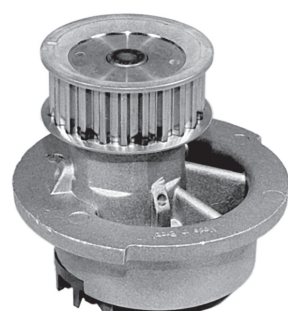

**NKBA03163**

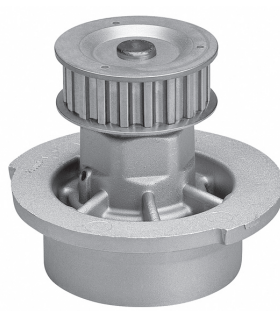

**NKBA03167**



**NKBA03328**

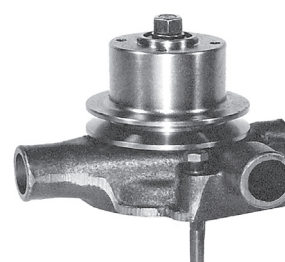

**NKBA03329**



**NKBA03341**

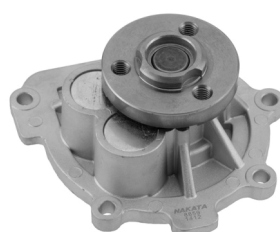

**NKBA03826**



**NKBA04318**



**NKBA04325**

**Bomba d'água**



**NKBA04326**

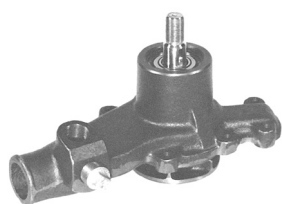

**NKBA04332**

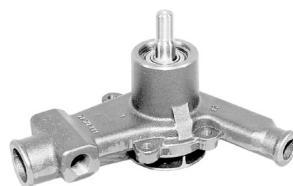

**NKBA04333**

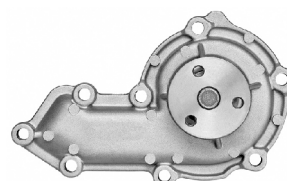

**NKBA04340**



**NKBA04553**

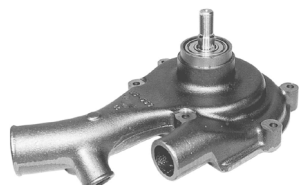

**NKBA04554**

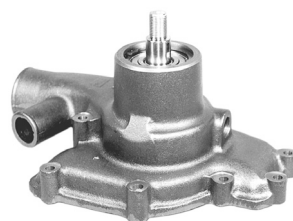

**NKBA04560**

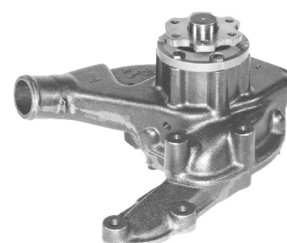

**NKBA05313**

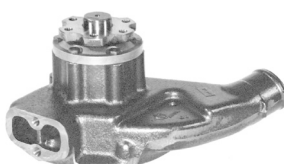

**NKBA05314**

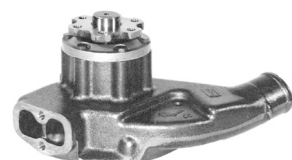

**NKBA05316**

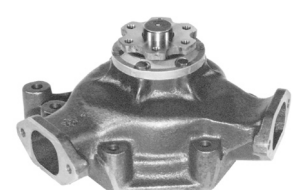

**NKBA05355**



**NKBA05362**



**NKBA05366**



**NKBA05367**



**NKBA05368**



**NKBA05369**

**Bomba d'água**



**NKBA05370**

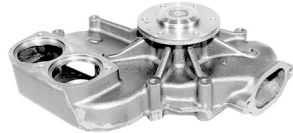

**NKBA05372**



**NKBA05373**



**NKBA05374**

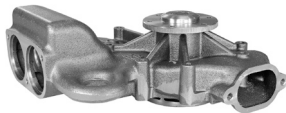

**NKBA05375**



**NKBA05376**



**NKBA05380**

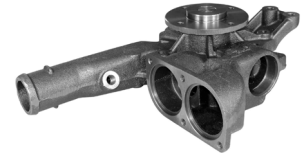

**NKBA05381**

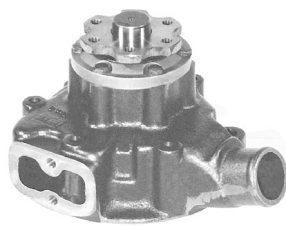

**NKBA05608**



**NKBA05609**

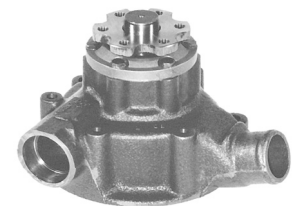

**NKBA05610**



**NKBA06573**

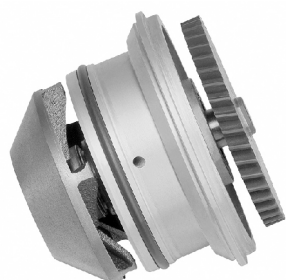

**NKBA06574**

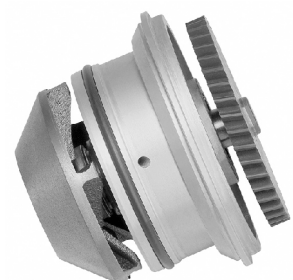

**NKBA06575**



**NKBA06576**

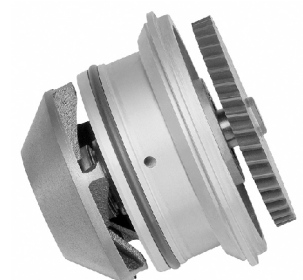

**NKBA06577**

**Bomba d'água**



**NKBA06578**



**NKBA06579**



**NKBA07625**



**NKBA07626**



**NKBA07627**



**NKBA07628**



**NKBA07629**



**NKBA07630**

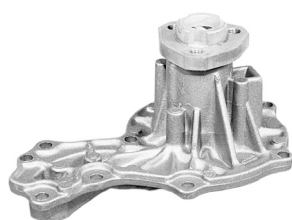

**NKBA07631**



**NKBA07633**



**NKBA07636**



**NKBA07640**



**NKBA08807**



**NKBA08808**



**NKBA09800**



**NKBA09805**

**Bomba d'água**

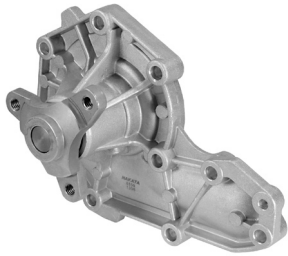

**NKBA09813**

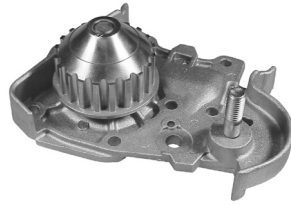

**NKBA09815**

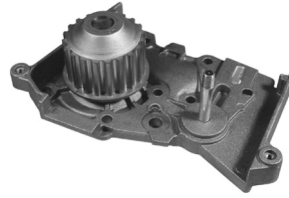

**NKBA09820**



**NKBA10731**

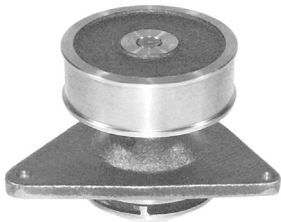

**NKBA10732**



**NKBA10733**

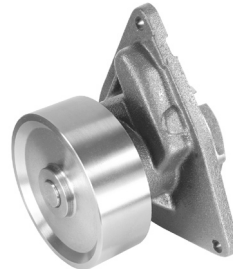

**NKBA10734**



**NKBA11980**



**NKBA11981**

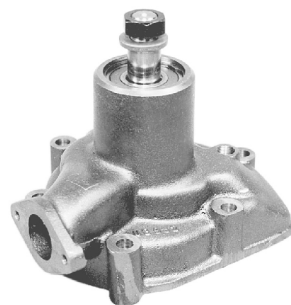

**NKBA11982**



**NKBA11984**



**NKBA12604**



**NKBA12605**

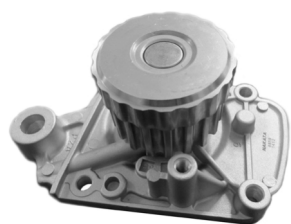

**NKBA12606**



**NKBA16703**

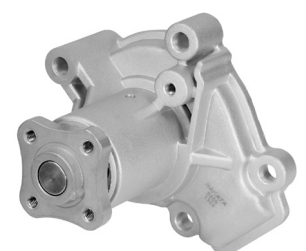

**NKBA17420**

**Bomba d'água**

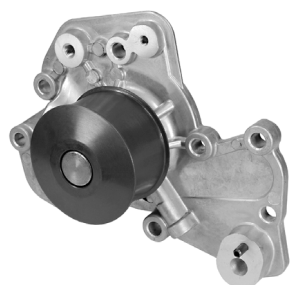

**NKBA17421**



**NKBA33582**



**NKBA089013**



**NKBA089018**

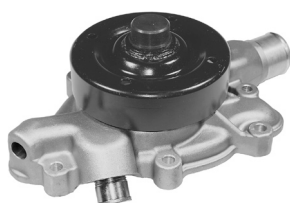

**NKBA139003**

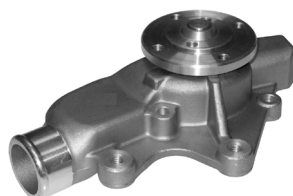

**NKBA139012**



**NKBA169009**



**NKBA169014**



**NKBA169019**

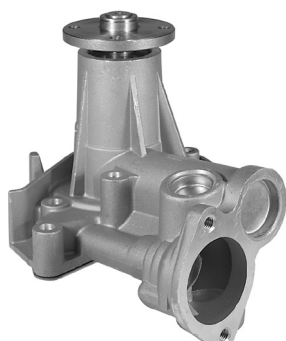

**NKBA179004**

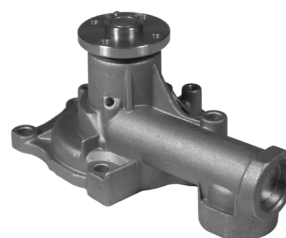

**NKBA179007**



**NKBA189017**

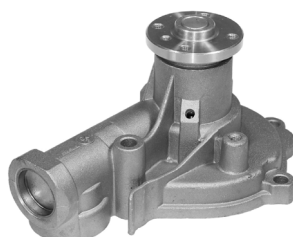

**NKBA309002**



**NKBR02067**



**NKBR03759**

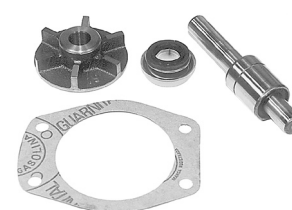

**NKBR04319**

**Bomba d'água**



**NKBR04392**



**NKBR04393**



**NKBR04554**



**NKBR04559**



**NKBR04561**



**NKBR05608**



**NKBR05709**



**NKBR06575**



**NKBR07391**

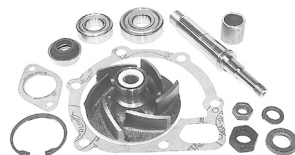

**NKBR11983**



**NKBR11985**



**NKBR14200**



**NKBR14202**



**NKBR33478**



**NKBR051313**



**NKBR051315**



**Bomba d'água**



**NKBR051356**



**NKBR051358**



**NKBR051364**



**NKBR051371**



**NKBR051372**



**NKBR051373**



**NKBR051374**



**NKBR051375**



**NKBR121100**

<b>BROSOL</b>	<b>Nakata</b>	<b>INDISA</b>	<b>Nakata</b>	<b>INDISA</b>	<b>Nakata</b>	<b>INDISA</b>	<b>Nakata</b>
310200	NKBA07625	25013	NKBA03135	7000153000	NKBA04318	7000401000	NKBA05608
310300	NKBA07627	25018	NKBA03150	7000153001	NKBA03329	7000401001	NKBA05314
310400	NKBA07628	25021	NKBA03132	7000153003	NKBA04325	7000401003	NKBA05366
310500	NKBA07629	25047	NKBA03149	7000153005	NKBA04553	7000401004	NKBA05355
310600	NKBA07630	25051	NKBA03140	7000156004	NKBR04561	7000401008	NKBA05610
310700	NKBA07631	25059	NKBA03147	7000201000	NKBA33582	7000401010	NKBA05372
340100	NKBA03149	25061	NKBA03152	7000201003	NKBA02590	7000401011	NKBA05370
341200	NKBA03132	25063	NKBA03157	7000204000	NKBA02944	7000401012	NKBA05368
342100	NKBA03135	25073	NKBA04560	7000204001	NKBA02942	7000401014	NKBA05373
343100	NKBA03152	25075	NKBA03128	7000204002	NKBA02054	7000401018	NKBA05381
344100	NKBA03147	25081	NKBR03759	7000204003	NKBA02092	7000404000	NKBA04340
344200	NKBA03148	35001	NKBA01748	7000204004	NKBA02946	7000404001	NKBA05376
350100	NKBA02943	35005	NKBA01753	7000204005	NKBA02945	7000452000	NKBA10732
350200	NKBA02942	35007	NKBA01752	7000204007	NKBA02948	7000452001	NKBA07630
350300	NKBA02947	35009	NKBA01751	7000204008	NKBA02950	7000452002	NKBA10731
352400	NKBA02944	35013	NKBA01757	7000205000	NKBA02943	7000452003	NKBA07629
380200	NKBA01748	40001	NKBR05608	7000252000	NKBA03150	7000452006	NKBA07633
380300	NKBA01753	40002	NKBA05608	7000252001	NKBA03149	7000452008	NKBA10733
380400	NKBA01749	40005	NKBR051358	7000252002	NKBA03147	7000454000	NKBA07627
380500	NKBA01751	40009	NKBR051356	7000252003	NKBA03152	7000454001	NKBA07625
380600	NKBA01752	40015	NKBA05314	7000252004	NKBA04560	7000454002	NKBA07628
380700	NKBA01761	40017	NKBA05313	7000252005	NKBA03148	7000454003	NKBA07626
380800	NKBA01764	40021	NKBR051313	7000252007	NKBA03157	7000454005	NKBA07632
380850	NKBA01763	40027	NKBA05316	7000252008	NKBA03162	7000552001	NKBA11981
		40033	NKBR051315	7000252009	NKBA03163	7000553000	NKBA11982
		40035	NKBR051364	7000252010	NKBA03167	7000553001	NKBA11984
		40041	NKBA05366	7000253000	NKBA04560	7000854005	NKBA309016
		40045	NKBA05355	7000254000	NKBA03135	7000904000	NKBA169019
		40051	NKBR05709	7000254003	NKBA03140	7000904001	NKBA169014
		40055	NKBA05362	7000254005	NKBA03128	7000952002	NKBA089018
		40063	NKBA05610	7000254006	NKBA03160	7000952003	NKBA089013
		401013	NKBA05380	7000254008	NKBA03341		
		45001	NKBA07627	7000258002	NKBA03132	<b>SCHADEK</b>	<b>Nakata</b>
		45003	NKBA07625	7000352000	NKBA01751	202261	NKBA01769
		45005	NKBA07628	7000352001	NKBA01757	16001	NKBR051315
		45009	NKBA07626	7000352002	NKBA01761	16002	NKBR05608
		45013	NKBA10732	7000352004	NKBA01756	16003	NKBR05709
		55001	NKBR11983	7000352007	NKBA01770	16004	NKBR051364
		55009	NKBR11985	7000352010	NKBA01763	16006	NKBR051358
		55021	NKBA11982	7000354000	NKBA01748	16007	NKBR051356
		55023	NKBA11984	7000354001	NKBA01753	16008	NKBR051313
		552000	NKBA11980	7000354002	NKBA01752	16009	NKBR06574
		7000104000	NKBA06576	7000354003	NKBA01764	16010	NKBR06575
		7000104001	NKBA06578	7000354004	NKBA01758	16011	NKBR04554
		7000105001	NKBA06579	7000354005	NKBA01760	16011	NKBR04559
		7000105002	NKBA06577	7000354007	NKBA01780	16013	NKBR07391
		7000152000	NKBA04326	7000354009	NKBA01766	16014	NKBR04392
		7000152002	NKBA04332	7000354010	NKBA01749	16015	NKBR04561
		7000152003	NKBA03328	7000400001	NKBA05316	16016	NKBR04393
		7000152004	NKBA04554	7000400005	NKBA05369	16020	NKBR051373
		7000152007	NKBA04333	7000400006	NKBA05367	16020	NKBR051374
						16021	NKBR11985

**Tabela de Equivalência / Bomba D'Água AM**  
**Cruce de Referências / Bomba de Agua AM**  
**Cross Reference List / Water Pumps AM**



SCHADEK	Nakata	SCHADEK	Nakata	SCHADEK	Nakata	SKF	Nakata
16022	NKBR11983	20080	NKBA10731	20197	NKBA10733	VKPC4674	NKBA10732
16025	NKBR121300	20084	NKBA11984	20198I	NKBA03341	VKPC4675	NKBA05610
16026	NKBR051372	20085	NKBA11982	20202I	NKBA02950	VKPC4677	NKBA05316
16028	NKBR051371	20086	NKBA07629	20205	NKBA05375	VKPC4678	NKBA05355
16044	NKBR051375	20087	NKBA03157	20206I	NKBA09805	VKPC4681	NKBA05362
16047	NKBR051376	20088	NKBA03148	20207I	NKBA09800	VKPC4685	NKBA05367
20001	NKBA03149	20089	NKBA07630	20209	NKBA16703	VKPC4686	NKBA05370
20002	NKBA01748	20092	NKBA04318	20210I	NKBA09815	VKPC4688	NKBA05372
20004	NKBA02942	20093	NKBA06577	20211I	NKBA02951	VKPC4689	NKBA05373
20005	NKBA02944	20094	NKBA03160	20218	NKBA08807	VKPC4690R	NKBR04392
20008	NKBA02943	20095	NKBA03128	20219	NKBA08808	VKPC4691R	NKBR07391
20009	NKBA05316	20096I	NKBA01761	20221I	NKBA02948	VKPC4692R	NKBR05608
20009A	NKBA05316	20097	NKBA01760	202231	NKBA12606	VKPC4693R	NKBR051356
20010	NKBA06576	20100I	NKBA01780	20225	NKBA12604	VKPC4694R	NKBR051313
20015	NKBA03132	20101	NKBA07632	20227I	NKBA03826	VKPC4695R	NKBR051364
20022	NKBA03135	20102	NKBA02947	20232	NKBA179004	VKPC4696R	NKBR05709
20023	NKBA03140	20104	NKBA01763	20235I	NKBA139003	VKPC4697	NKBA10731
20024	NKBA07625	20108I	NKBA01756	<b>SKF</b>	<b>Nakata</b>	VKPC4698	NKBA05380
20025	NKBA07627	20110	NKBA089018	VKPC4548	NKBA04332	VKPC4699R	NKBR051358
20027	NKBA07626	20119	NKBA05368	VKPC4551	NKBA03328	VKPC4700R	NKBR051315
20028	NKBA01751	20119A	NKBA05367	VKPC4552	NKBA04554	VKPC4702R	NKBR051364
20029	NKBA05608	20120	NKBA05370	VKPC4557	NKBA04553	VKPC4720R	NKBR051371
20030	NKBA05609	20120A	NKBA05369	VKPC4560	NKBA04560	VKPC4721R	NKBR051372
20030	NKBA05610	20127	NKBA01749	VKPC4564	NKBA04333	VKPC4722R	NKBR051373
20031	NKBA05366	20128	NKBA07631	VKPC4566	NKBA02590	VKPC4896	NKBA139003
20031A	NKBA05366	20129	NKBA02590	VKPC4567	NKBA02942	VKPC4897	NKBA01758
20035	NKBA06578	20132	NKBA04326	VKPC4568	NKBA02054	VKPC4900	NKBA05368
20036	NKBA03152	20134	NKBA07633	VKPC4570	NKBA02092	VKPC4902	NKBA05369
20038	NKBA03150	20136	NKBA04325	VKPC4571	NKBA02946	VKPC4903	NKBA10732
20040	NKBA01757	20138	NKBA03329	VKPC4573	NKBA03150	VKPC4906	NKBA11982
20044	NKBA01752	20139	NKBA04553	VKPC4575	NKBA03135	VKPC4910	NKBA11984
20045	NKBA05313	20142	NKBA04332	VKPC4576	NKBA03128	VKPC81210A	NKBA07630
20045A	NKBA05314	20143	NKBA01766	VKPC4580	NKBA01751	VKPC81400	NKBA07626
20046A	NKBA05362	20144	NKBA11980	VKPC4582	NKBA01757	VKPC81401	NKBA07627
20047	NKBA05355	20145	NKBA03162	VKPC4583	NKBA01763	VKPC81401A	NKBA07627
20048	NKBA01753	20146	NKBA03163	VKPC4585	NKBA01752	VKPC81401AD	NKBA07628
20049	NKBA06579	20147	NKBA04333	VKPC4586	NKBA01749	VKPC81411A	NKBA07629
20053	NKBA01764	20150	NKBA04560	VKPC4589	NKBA02943	VKPC81620	NKBA07633
20054	NKBA01764	20153	NKBA05380	VKPC4591	NKBA03167	VKPC82131A	NKBA01764
20055	NKBA03147	20154	NKBA05373	VKPC4601	NKBA03163	VKPC82173A	NKBA01753
20056	NKBA04554	20154	NKBA05374	VKPC4602	NKBA03162	VKPC82208	NKBA01748
20058	NKBA04332	20160I	NKBA09820	VKPC4604	NKBA07636	VKPC82208A	NKBA01748
20060	NKBA04560	20163	NKBA06574	VKPC4663	NKBA06578	VKPC82216	NKBA01752
20061	NKBA04333	20164	NKBA06575	VKPC4664	NKBA33582	VKPC82230A	NKBA03162
20062	NKBA03328	20168	NKBA05381	VKPC4665	NKBA05313	VKPC82245A	NKBA01761
20063	NKBA02946	20176I	NKBA09813	VKPC4666	NKBA05314	VKPC82251A	NKBA01766
20064	NKBA05372	20180	NKBA089013	VKPC4667	NKBA04326	VKPC82441A	NKBA01756
20065	NKBA33582	20182I	NKBA139012	VKPC4668	NKBA05366	VKPC82645A	NKBA01771
20069	NKBA04340	20185	NKBA169014	VKPC4669	NKBA06579	VKPC82646	NKBA01770
20071	NKBA07628	20193	NKBA10734	VKPC4670	NKBA04325	VKPC82647	NKBA01760
20079	NKBA10732	20195	NKBA11981	VKPC4671	NKBA03329	VKPC82652	NKBA01780

**Tabela de Equivalência / Bomba D'Água AM**  
**Cruce de Referencias / Bomba de Agua AM**  
**Cross Reference List / Water Pumps AM**



SKF	Nakata	UNIBOMBAS	Nakata	UNIBOMBAS	Nakata	URBA	Nakata
VKPC83205	NKBA089018	BD9149	NKBA02946	BD9871	NKBA07636	UB0380	NKBA05380
VKPC83428	NKBA089013	BD9163	NKBA02947	RD8401	NKBR051313	UB0381	NKBA05381
VKPC83430	NKBA08808	BD9216	NKBA10732	RD8405	NKBR051315	UB0420	NKBA17420
VKPC83644	NKBA08807	BD9217	NKBA10732	RD8447	NKBR051364	UB0553	NKBA04553
VKPC84131A	NKBA06576	BD9218	NKBA10731	RD8451	NKBR05608	UB0554	NKBA04554
VKPC84132A	NKBA02944	BD9220	NKBA10734	RD8571	NKBR06574	UB0560	NKBA04560
VKPC84215	NKBA02948	BD9250	NKBA169014	RD8783CR	NKBR07391	UB0573	NKBA06573
VKPC84216	NKBA02946	BD9337	NKBA03160	RD8793CR	NKBR04392	UB0574	NKBA06574
VKPC84406	NKBA02945	BD9339	NKBA03157	RD8794CR	NKBR04554	UB0575	NKBA06575
VKPC84406A	NKBA02945	BD9356	NKBA03132			UB0576	NKBA06576
VKPC84419A	NKBA02947	BD9357	NKBA03135	<b>URBA</b>	<b>Nakata</b>	UB0577	NKBA06577
VKPC84425A	NKBA04340	BD9359	NKBA03140	UB0054	NKBA02054	UB0578	NKBA06578
VKPC85093A	NKBA04333	BD9368	NKBA03128	UB0092	NKBA02092	UB0579	NKBA06579
VKPC85206	NKBA03147	BD9376	NKBA03149	UB0128	NKBA03128	UB0582	NKBA33582
VKPC85206A	NKBA03147	BD9377	NKBA03150	UB0134	NKBA03132	UB0590	NKBA02590
VKPC85211	NKBA03148	BD9378	NKBA03152	UB0135	NKBA03135	UB0604	NKBA12604
VKPC85211A	NKBA03148	BD9379	NKBA03148	UB0140	NKBA03140	UB0608	NKBA05608
VKPC85400	NKBA03149	BD9380	NKBA03147	UB0147	NKBA03147	UB0610	NKBA05610
VKPC85400A	NKBA03149	BD9381	NKBA03341	UB0148	NKBA03148	UB0625	NKBA07625
VKPC85409	NKBA03152	BD9411	NKBA05313	UB0149	NKBA03149	UB0626	NKBA07626
VKPC85409A	NKBA03152	BD9412	NKBA05314	UB0150	NKBA03150	UB0627	NKBA07627
VKPC85611A	NKBA03157	BD9420	NKBA05316	UB0152	NKBA03152	UB0628	NKBA07628
VKPC86413A	NKBA09813	BD9424	NKBA05355	UB0157	NKBA03157	UB0629	NKBA07629
VKPC86415	NKBA09815	BD9426	NKBA05368	UB0160	NKBA03160	UB0630	NKBA07630
VKPC86416	NKBA09820	BD9443	NKBA05367	UB0162	NKBA03162	UB0631	NKBA07631
VKPC91416	NKBA169009	BD9444	NKBA05366	UB0163	NKBA03163	UB0632	NKBA07632
VKPC91607A	NKBA169014	BD9450	NKBA05608	UB0165	NKBA03826	UB0633	NKBA07633
VKPC94424	NKBA179007	BD9452	NKBA05610	UB0167	NKBA03167	UB0636	NKBA07636
VKPC95852	NKBA17420	BD9460	NKBA05372	UB0313	NKBA05313	UB0636	NKBA07636
		BD9572	NKBA06576	UB0314	NKBA05314	UB0703	NKBA16703
<b>UNIBOMBAS</b>	<b>Nakata</b>	BD9573	NKBA06579	UB0316	NKBA05316	UB0731	NKBA10731
BD9013	NKBA01749	BD9595	NKBA06577	UB0318	NKBA04318	UB0732	NKBA10732
BD9015	NKBA01748	BD9597	NKBA06578	UB0325	NKBA04325	UB0748	NKBA01748
BD9018	NKBA01752	BD9600	NKBA11982	UB0326	NKBA04326	UB0749	NKBA01749
BD9021	NKBA01764	BD9699	NKBA11984	UB0328	NKBA03328	UB0751	NKBA01751
BD9022	NKBA01751	BD9774	NKBA04340	UB0329	NKBA03329	UB0752	NKBA01752
BD9023	NKBA01763	BD9781	NKBA04318	UB0332	NKBA04332	UB0753	NKBA01753
BD9027	NKBA01756	BD9784	NKBA04326	UB0333	NKBA04333	UB0756	NKBA01756
BD9028	NKBA01761	BD9786	NKBA03328	UB0340	NKBA04340	UB0757	NKBA01757
BD9029	NKBA01757	BD9788	NKBA04332	UB0341	NKBA03341	UB0758	NKBA01758
BD9030	NKBA01753	BD9790	NKBA04333	UB0355	NKBA05355	UB0760	NKBA01760
BD9034	NKBA01766	BD9791	NKBA03329	UB0362	NKBA05362	UB0761	NKBA01761
BD9035	NKBA01770	BD9795	NKBA04553	UB0366	NKBA05366	UB0763	NKBA01763
BD9036	NKBA01752	BD9798	NKBA04554	UB0367	NKBA05367	UB0764	NKBA01764
BD9036	NKBA01758	BD9861	NKBA07625	UB0368	NKBA05368	UB0766	NKBA01766
BD9038	NKBA01780	BD9862	NKBA07627	UB0369	NKBA05369	UB0770	NKBA01770
BD9125	NKBA02942	BD9864	NKBA07626	UB0370	NKBA05370	UB0771	NKBA01771
BD9131	NKBA02943	BD9865	NKBA07628	UB0372	NKBA05372	UB0780	NKBA01780
BD9132	NKBA02945	BD9866	NKBA07628	UB0373	NKBA05373	UB0800	NKBA09800
BD9138	NKBA02944	BD9869	NKBA07630	UB0374	NKBA05374	UB0805	NKBA09805
BD9143	NKBA02950	BD9870	NKBA07629	UB0375	NKBA05375	UB0807	NKBA08807
BD9147	NKBA02948			UB0376	NKBA05376	UB0808	NKBA08808

**Tabela de Equivalência / Bomba D'Água AM**  
**Cruce de Referências / Bomba de Agua AM**  
**Cross Reference List / Water Pumps AM**



<b>URBA</b>	<b>Nakata</b>	<b>URBA</b>	<b>Nakata</b>	<b>VETORE</b>	<b>Nakata</b>	<b>VETORE</b>	<b>Nakata</b>
UB0813	NKBA09813	UR1100RL	NKBR121100	VBD110	NKBA01764	VBD560	NKBA04560
UB0815	NKBA09815	UR1200RL	NKBR12200	VBD111	NKBA01766	VBD576	NKBA06576
UB0820	NKBA09820	UR1300RL	NKBR121300	VBD114	NKBA01756	VBD578	NKBA06578
UB0942	NKBA02942	UR1313RL	NKBR051313	VBD115	NKBA01770	VBD579	NKBA06579
UB0943	NKBA02943	UR1315RL	NKBR051315	VBD116	NKBA03140	VBD580	NKBA06577
UB0944	NKBA02944	UR1356RL	NKBR051356	VBD117	NKBA03149	VBD585	NKBA06573
UB0945	NKBA02945	UR1358RL	NKBR051358	VBD119	NKBA03135	VBD590	NKBA02590
UB0946	NKBA02946	UR1364RL	NKBR051364	VBD120	NKBA03147	VBD608	NKBA05608
UB0947	NKBA02947	UR1371RL	NKBR051371	VBD121	NKBA03152	VBD609	NKBA05609
UB0948	NKBA02948	UR1372RL	NKBR051372	VBD122	NKBA03148	VBD610	NKBA05610
UB0950	NKBA02950	UR1373RL	NKBR051373	VBD123	NKBA03157	VBD611	NKBA05376
UB0955	NKBA02951	UR1374RL	NKBR051374	VBD124	NKBA03150	VBD904	NKBA05380
UB0980	NKBA11980	UR1375RL	NKBR051375	VBD125	NKBA03163	VBD926	NKBA05381
UB0981	NKBA11981	UR1376RL	NKBR051376	VBD127	NKBA02942	VBD982	NKBA11982
UB0982	NKBA11982	UR1377RL	NKBR051377	VBD128	NKBA02947	VBD984	NKBA11984
UB0984	NKBA11984			VBD129	NKBA09820	VBD991	NKBA11981
UB9002	NKBA309002	<b>VETORE</b>	<b>Nakata</b>	VBD139	NKBA089013	VDB335	NKBA10732
UB9003	NKBA139003	VBA1313RL	NKBR051313	VBD142	NKBA07627	VDB988	NKBA11980
UB9004	NKBA179004	VBA1315RL	NKBR051315	VBD143	NKBA169014		
UB9006	NKBA189006	VBA1356RL	NKBR051356	VBD144	NKBA169009		
UB9007	NKBA179007	VBA1358RL	NKBR051358	VBD147	NKBA179004		
UB9008	NKBA189008	VBA1363RL	NKBR051364	VBD157	NKBA179011		
UB9009	NKBA169009	VBA1376RL	NKBR051372	VBD158	NKBA189017		
UB9011	NKBA179011	VBA1386RL	NKBR051371	VBD200	NKBA04340		
UB9012	NKBA139012	VBA1926RL	NKBR051376	VBD250	NKBA01780		
UB9013	NKBA089013	VBA366	NKBR051371	VBD313	NKBA05313		
UB9014	NKBA169014	VBA391RL	NKBR07391	VBD314	NKBA05314		
UB9016	NKBA309016	VBA392RL	NKBR04392	VBD316	NKBA05316		
UB9017	NKBA189017	VBA393RL	NKBR04393	VBD325	NKBA04325		
UB9018	NKBA089018	VBA400RL	NKBR051373	VBD326	NKBA04326		
UB9019	NKBA169019	VBA425RL	NKBR121100	VBD328	NKBA10731		
UB9021	NKBA059021	VBA457RL	NKBR051374	VBD329	NKBA03329		
UR0067	NKBR02067	VBA460RL	NKBR051377	VBD332	NKBA04332		
UR0200RL	NKBR14200	VBA554RL	NKBR04554	VBD333	NKBA04333		
UR0202RL	NKBR14202	VBA561RL	NKBR04561	VBD335	NKBA10732		
UR0319	NKBR04319	VBA574	NKBR06574	VBD338	NKBA10733		
UR0391RL	NKBR07391	VBA575	NKBR06575	VBD340	NKBA10734		
UR0392RL	NKBR04392	VBA608RL	NKBR05608	VBD355	NKBA05355		
UR0393RL	NKBR04393	VBA688RL	NKBR121300	VBD362	NKBA05362		
UR0478	NKBR33478	VBA7010RL	NKBR14202	VBD366	NKBA05366		
UR0554RL	NKBR04554	VBA7020RL	NKBR14200	VBD375	NKBA05369		
UR0559RL	NKBR04559	VBA709RL	NKBR05709	VBD376	NKBA05370		
UR0561RL	NKBR04561	VBA983RL	NKBR11983	VBD385	NKBA05367		
UR0574	NKBR06574	VBA985RL	NKBR11985	VBD386	NKBA05368		
UR0575	NKBR06575	VBD100	NKBA07627	VBD387	NKBA05367		
UR0608RL	NKBR05608	VBD101	NKBA07625	VBD400	NKBA05372		
UR0709RL	NKBR05709	VBD102	NKBA07628	VBD457	NKBA05373		
UR0759	NKBR03759	VBD103	NKBA07630	VBD458	NKBA05374		
UR0983RL	NKBR11983	VBD104	NKBA07629	VBD460	NKBA05375		
UR0985RL	NKBR11985	VBD105	NKBA07632	VBD553	NKBA04553		
UR1000RL	NKBR121000	VBD106	NKBA07633	VBD554	NKBA04554		
		VBD109	NKBA01748				

**Tabela de Equivalência / Bomba D'Água OE****Cruce de Referencias / Bomba de Agua OE****Cross Reference List / Water Pumps OE****NAKATA®**

<b>AGRALE</b>	<b>Nakata</b>	<b>DAEWOO</b>	<b>Nakata</b>	<b>FIAT</b>	<b>Nakata</b>	<b>FORD</b>	<b>Nakata</b>
6013101103007	NKBA06573	92064250	NKBA03157	7762926	NKBA01770	922987310036	NKBA06578
92200507310015	NKBA06576			7770034	NKBA01761	928X8591AA	NKBA02945
922500190057	NKBR06574	<b>DODGE</b>	<b>Nakata</b>	7783006	NKBA01760	961007310016	NKBA06579
922900190417	NKBR06575	53021018	NKBA139003	7784977	NKBA01761	961087310026	NKBA06579
922907310015	NKBA06578	53021018	NKBA309002	7784983	NKBA01752	96BM8501EC	NKBA02946
922987310026	NKBA06576			7784984	NKBA01752	96BM8501FA	NKBA02946
922987310036	NKBA06578	<b>FIAT</b>	<b>Nakata</b>	7784987	NKBA01761	96BX8591AA	NKBA02946
		120170	NKBA01780	7784988	NKBA01761	96MX8591AA	NKBA02948
<b>CHRYSLER</b>	<b>Nakata</b>	4336009	NKBA01748	97000656	NKBA01751	988X8591F1D	NKBA02950
3618992	NKBA06576	4336009	NKBA01749	97053807	NKBA01757	A84SU8591A	NKBA02944
3873005	NKBR06574	4405285	NKBA01752	97054801	NKBA01758	B4MU8501A	NKBA02943
4099220VW	NKBA04553	4429224	NKBA01752	97650785	NKBA01766	BD4B8501A	NKBA02054
4099220VWX	NKBA04554	4465144	NKBA01752	98473452	NKBA01780	BD5D8501	NKBA02092
423623	NKBR07391	46400058	NKBA01756	99440717	NKBA01780	BD5D8501A	NKBA02092
424816	NKBR07391	46410549	NKBA01764			BD9M8591A	NKBA02943
635714	NKBR04554	46437912	NKBA01764	<b>FORD</b>	<b>Nakata</b>	BD9M8591B	NKBA02942
70990329	NKBA03329	46444355	NKBA01756	026121005A	NKBA07627	BE4M8591A	NKBA02943
70990553X	NKBA04554	46463042	NKBA01764	026121005H	NKBA07628	BF5X8501A	NKBA10731
70990563	NKBA04553	46463043	NKBA01764	026121005Q	NKBA07627	BG1X8501AA	NKBA10732
70990563X	NKBA04554	46516713	NKBA01753	068121005A	NKBA07627	BG5X8501AA	NKBA10733
70991068X	NKBA04554	46520401	NKBA01766	10003987	NKBA02946	BG6X8501AA	NKBA10734
70991175X	NKBA04326	46527473	NKBA01763	102567	NKBA02946	BG7X8501AA	NKBA10734
70991409	NKBA04553	46751181	NKBA01766	1S7Z8501AK	NKBA02951	BG9A8591AA	NKBA02947
70991409X	NKBA04554	50003672	NKBA01752	261210052	NKBA07627	D8FZ8501A	NKBA02092
70991412	NKBA03329	55186602	NKBA01766	261210053	NKBA07628	D8NN8501NA	NKBA33582
922500190057	NKBR06574	55205557	NKBA01766	291210121	NKBA02944	E7HN8A513AB	NKBA02590
922507310015	NKBA06576	55208348	NKBA01766	291211211	NKBA02944	EPW55	NKBA02945
922977310026	NKBA06576	55217970	NKBA01766	291950051	NKBA02944	FAPN5A513GG	NKBA33582
P70991409A	NKBA04553	55240487	NKBA01767	291980051	NKBA02944	P635714A	NKBR04554
P70991409AX	NKBA04554	55243968	NKBA01767	2S6G8591AD	NKBA02947	P70991409A	NKBA04553
T93121005X	NKBA04326	5882691	NKBA01748	3802358	NKBA10731	P70991409AX	NKBA04554
T94121005	NKBA04553	5882691	NKBA01749	3802970	NKBA10731	VLBA0330532	NKBA07627
T94121005X	NKBA04554	5890406	NKBA01748	4BF5T8508AA	NKBA04340	WD5T8501A	NKBA06576
		5890406	NKBA01749	4BF7T8501AB	NKBA04340	WD5T8591A	NKBR06574
<b>CITROEN</b>	<b>Nakata</b>	5924366	NKBA01752	4S4Z8501AA	NKBA02951	X56E8501AD	NKBA02947
120100000	NKBA08808	5990701	NKBA01752	5025607	NKBA02945	XS6E8501AD	NKBA02947
1201G0	NKBA08807	60586222	NKBA01771	643534	NKBR02067	YS6G8501A2C	NKBA02948
9608564280	NKBA089013	60811328	NKBA01771	643564	NKBA02054		
		7074817	NKBA01752	646842	NKBR02067	<b>GENERAL MOTORS</b>	<b>Nakata</b>
<b>CUMMINS</b>	<b>Nakata</b>	7075182	NKBA01757	70990553X	NKBA04554	000S4057	NKBA04333
3800984	NKBA10733	7083258	NKBA03162	70990563	NKBA04553	12528917	NKBA03341
3802081	NKBA10732	7083258	NKBA03163	70990563X	NKBA04554	12532528	NKBA03160
3802973	NKBA10732	7083361	NKBA03162	70991409	NKBA04553	12532528	NKBA03341
3806180	NKBA10732	7084922	NKBA03162	70991409X	NKBA04554	1334008	NKBA03150
3913430	NKBA10732	7087004	NKBA03162	7099168X	NKBA04554	1334013	NKBA03149
3973114	NKBA10734	7590753	NKBA01751	84TU8501A	NKBA02092	1334025	NKBA03147
4089647	NKBA10734	7628880	NKBA01748	86AV8501AA	NKBA02944	1334041	NKBA03157
4891252	NKBA10733	7628880	NKBA01749	922500190057	NKBR06574	1334046	NKBA03148
4945053	NKBA10734	7712251	NKBA01753	922507310015	NKBA06576	1334050	NKBA03157
		7720987	NKBA01761	922900190417	NKBR06575	1334054	NKBA03152
<b>DAEWOO</b>	<b>Nakata</b>	7737200	NKBA01761	922907310015	NKBA06578	1334065	NKBA03147
90272361	NKBA03150	7744397	NKBA01761	922987310026	NKBA06576	1334135	NKBA03163
90325660	NKBA03147						
90466343	NKBA03157						

<b>GENERAL MOTORS Nakata</b>		<b>GENERAL MOTORS Nakata</b>		<b>MERCEDES BENZ Nakata</b>		<b>MERCEDES BENZ Nakata</b>	
24405895	NKBA03826	93231147	NKBA03149	0002000101	NKBA04340	4572000201	NKBA05373
41313033	NKBA04560	93231147X	NKBA03150	0002001501	NKBA04340	4572000201	NKBA05374
41313047	NKBA04560	93278547	NKBA03147	0002010101	NKBA04340	4572000501	NKBA05374
424816	NKBR07391	93280924	NKBA03148	0002010101ERR329	NKBA04340	4572004701	NKBA05373
52250937	NKBA03149	93284724	NKBA03157	0090420001	NKBR051375	4572007001	NKBA05373
52250937X	NKBA03150	93284725	NKBA03152	0942002501	NKBA05380	4602000001	NKBA05375
52258899	NKBA03135	93302485	NKBA03167	1662000320	NKBA059021	4752000001	NKBA05372
52258901	NKBA03140	93368514	NKBA03162	2010101	NKBA04340	4752000101	NKBA05372
52258902	NKBA03140	93368514	NKBA03163	3142000601	NKBA05608	4752000201	NKBA05372
52267860	NKBA03132	93385842	NKBA03167	3142002901	NKBA05608	6112000801	NKBA05376
52267860X	NKBA03132	93385844	NKBA03162	3452000201	NKBA05355	6112001101	NKBA05376
52267861X	NKBA03132	93385866	NKBA03163	3452007101	NKBA05355	9042000201	NKBA05380
54057	NKBA04333	940707310035	NKBA06577	3522000560	NKBR051313	9042000204	NKBR051376
7083258	NKBA03162	94603682	NKBA03132	3522000801X	NKBA05362	9042000701	NKBA05380
7083361	NKBA03163	94603682X	NKBA03132	3522003801	NKBA05313	9042001901	NKBA05380
70990553X	NKBA04554	94610549	NKBA03140	3522003801X	NKBA05314	9042001901	NKBR051375
70990563	NKBA04553	94623690	NKBA03132	3522003811	NKBA05313	9042002001	NKBA05380
70990563X	NKBA04554	94623690X	NKBA03132	3522005401X	NKBA05362	9042002201	NKBA05380
70991068X	NKBA04554	94636985	NKBA03149	3522009101	NKBA05313	9042002501	NKBA05380
70991237X	NKBA03328	94647433	NKBA03140	3522009101X	NKBA05314	9042003201	NKBA05380
70991409	NKBA04553	94703783	NKBA03162	3522009401	NKBA05313	9062001401	NKBA05381
70991409X	NKBA04554	P635714A	NKBR04554	3522009401X	NKBA05314	9062002201	NKBA05381
70991416X	NKBA03328	P70991409A	NKBA04553	3522009601X	NKBA05362	9062002901	NKBA05381
70991456X	NKBA04332	P70991409X	NKBA04554	3525860420	NKBR051313	9062004201	NKBA05381
70992164X	NKBA04332	<b>HONDA Nakata</b>		3532000301	NKBA05313	9062004801	NKBA05381
70992165X	NKBA04332	19200PLMA01	NKBA12606	3532000301X	NKBA05314	9062005401	NKBA05381
70992422	NKBA04560	19200PWA003	NKBA12604	3532000301X	NKBA05316	9062005701	NKBA05381
70992563	NKBA04333	19200RNAA01	NKBA12605	3532001101X	NKBA05362	9062006101	NKBA05381
70993494	NKBA04340	<b>HYUNDAI Nakata</b>		3555860220	NKBR051356	9062011901	NKBA05381
7319453	NKBR03759	2510023010	NKBA17420	3642000001	NKBA05609	BF7T8501AA	NKBA04340
7322682	NKBA03135	2510033132	NKBA179007	3642000101	NKBA05610	ERR3290	NKBA04340
7359824	NKBA03128	2510037202	NKBA17421	3642002001	NKBA05610	ERR3290C	NKBA04340
89077748	NKBA03341	2510042540	NKBA179011	3662000401X	NKBA05366	<b>MITSUBISHI Nakata</b>	
90106656	NKBA03149	<b>IVECO Nakata</b>		3662000701X	NKBA05366	MD179030	NKBA139003
90325660	NKBA03147	503120262	NKBR14202	3662005601	NKBA05369	MD179030	NKBA309002
90443549	NKBA03157	503120263	NKBR14200	3662006801	NKBA05367	MD300799	NKBA139003
90444079	NKBA03148	504062854	NKBA10733	3662006801	NKBA05368	MD300799	NKBA309002
90444311	NKBA03157	<b>JEEP Nakata</b>		3662006801X	NKBA05368	MD306414	NKBA139003
90448047	NKBA03152	4626215	NKBA139012	3762000001	NKBA05369	MD306414	NKBA309002
90466343	NKBA03157	4626215AD	NKBA139012	3762000001X	NKBA05370	MD309756	NKBA309016
90466344	NKBA03152	53020280	NKBA139003	3762000501	NKBA05369	MD997150	NKBA179004
90466344	NKBA03157	53020280	NKBA309002	3762000501	NKBA05370	<b>MWM Nakata</b>	
90536039	NKBA03162	85503407	NKBA139012	3762000601	NKBA05369	836764215k	NKBA06576
90536039	NKBA03163	<b>KIA MOTORS Nakata</b>		3762000601X	NKBA05370	922507310015	NKBA06576
9192370	NKBA03157	0K65B15100	NKBA189017	3762000701	NKBA05369	922987310036	NKBA06578
9192797	NKBA03148	2510037102	NKBA17421	3762000901	NKBA05367	940707310035	NKBA06577
9199592	NKBA03148	8A13715010	NKBA189006	3762000901X	NKBA05368	940707310055	NKBA06575
9202460	NKBA03157	8ABB15010	NKBA189008	4222000604	NKBR051374	940807310026	NKBA06574
9306722X	NKBA03132	<b>MERCEDES BENZ Nakata</b>		4532004701	NKBA05373	961087310026	NKBA06579
93205938	NKBA03160			4572000101	NKBA05372	BF7T8501AA	NKBA04340
93224702	NKBA03149			4572000101	NKBA05373		

**Tabela de Equivalência / Bomba D'Água OE****Cruce de Referencias / Bomba de Agua OE****Cross Reference List / Water Pumps OE****NAKATA®**

<b>MWM</b>	<b>Nakata</b>
MMRB1404L	NKBR04392
MMRB1405L	NKBR04554
MMRB1410L	NKBR07391
MMRB1450L	NKBR051313
MMRB1451L	NKBR05608
MMRB1453L	NKBR051364
MMRB1454L	NKBR05709
<b>PERKINS</b>	<b>Nakata</b>
41313033	NKBA04560
41313047	NKBA04560
41313232X	NKBA04326
6354142	NKBA04560
70990318	NKBA04318
70991096X	NKBA04326
70991175X	NKBA04326
70991409	NKBA04553
70991409X	NKBA04554
70991412	NKBA03329
70991414	NKBA04318
70991416X	NKBA03328
70991456X	NKBA04332
70992165	NKBA04332
70992287	NKBA04325
70992287X	NKBA04326
70992422	NKBA04560
<b>PEUGEOT</b>	<b>Nakata</b>
120147	NKBA089018
1201F7	NKBA09800
120718	NKBA089018
120723	NKBA089018
<b>RENAULT</b>	<b>Nakata</b>
120158	NKBA089013
1201E4	NKBA089013
7700105176	NKBA09820
7700105378	NKBA09820
7700274330	NKBA09820
7700861686	NKBA09815
7701473365	NKBA09813
7701478923	NKBA09800
8200146297	NKBA09820
8200238333	NKBA09800
8200266947	NKBA09805
8200397735	NKBA09805
<b>SCANIA</b>	<b>Nakata</b>
1314406	NKBA11984
1353072	NKBA11980
1508533	NKBA11980
1546188	NKBA11981
1672680	NKBA11984
1789522	NKBA11981

<b>SCANIA</b>	<b>Nakata</b>
259065	NKBA11982
292761	NKBA11984
524866	NKBA11984
<b>TOYOTA</b>	<b>Nakata</b>
1610029415	NKBA16703
1610059257	NKBA169014
1611019145	NKBA169009
<b>VOLKSWAGEN</b>	<b>Nakata</b>
0261210053N	NKBA07628
026121005A	NKBA07627
026121005F	NKBA07632
026121005K	NKBA07632
026121005KLF	NKBA07632
026121005L	NKBA07632
026121005Q	NKBA07631
030121005N	NKBA07630
030121005T	NKBA07630
030121008A	NKBA07629
030121008D	NKBA07630
030121008L	NKBA07630
030121008M	NKBA07640
036121005D	NKBA07629
036121005E	NKBA07630
036121005H	NKBA07636
049121005A	NKBA07625
056121005A	NKBA07625
068121005A	NKBA07627
06A121011LT	NKBA07633
06A121011LX	NKBA07633
06A121012	NKBA07633
261210052	NKBA07627
261210053	NKBA07628
291980051	NKBA02944
2P0121004	NKBA06574
2R0121004A	NKBA06573
2R0121004B	NKBA06579
2R0121004B	NKBA10733
2RB121005	NKBA06576
2S0121004A	NKBA10732
2S0121004D	NKBA10731
2T2121004A	NKBA10734
2T2121004B	NKBA10734
36121005	NKBA07629
36121005MX	NKBA07629
681210051	NKBA07626
681210053	NKBA07625
A84SU8591A	NKBA02944
<b>VOLVO</b>	<b>Nakata</b>
20853857	NKBA06573
276814	NKBR12200

<b>VOLVO</b>	<b>Nakata</b>
3097203	NKBR121100
6889583	NKBR121300



Código/ Codigo/ PIN	Página/ Pagina/ Page
------------------------	----------------------------

**Veiculos de Passeio & Pick-ups / Vehiculos de Paseo y Camionet**

NKBA01748	Pag 8, 9, 10, 11, 12
NKBA01749	Pag 8, 9, 10, 11, 12
NKBA01751	Pag 9, 11, 13
NKBA01752	Pag 11, 12, 13
NKBA01756	Pag 8, 9, 10, 11, 12
NKBA01757	Pag 11, 13
NKBA01758	Pag 9, 11, 13
NKBA01761	Pag 12
NKBA01763	Pag 10, 11, 12
NKBA01764	Pag 9, 10, 12
NKBA01766	Pag 8, 9, 10, 11, 12
NKBA01767	Pag 8, 9, 10, 11, 12
NKBA01769	Pag 10, 11, 12, 8, 9
NKBA01772	Pag 8, 9, 10, 11, 12
NKBA01780	Pag 9
NKBA02054	Pag 13, 14
NKBA02092	Pag 13, 14
NKBA02942	Pag 13, 14
NKBA02943	Pag 13, 14
NKBA02944	Pag 13, 14, 20, 21
NKBA02945	Pag 13
NKBA02946	Pag 13, 14
NKBA02947	Pag 13, 14
NKBA02948	Pag 13, 14
NKBA02950	Pag 14
NKBA02951	Pag 13, 14
NKBA02952	Pag 13, 14
NKBA03128	Pag 15, 17
NKBA03132	Pag 15
NKBA03135	Pag 15, 16, 17
NKBA03140	Pag 17
NKBA03147	Pag 15, 16
NKBA03148	Pag 16
NKBA03149	Pag 16
NKBA03150	Pag 16
NKBA03152	Pag 15, 16, 17
NKBA03157	Pag 15, 17
NKBA03160	Pag 15, 16, 17
NKBA03162	Pag 9, 10, 11, 12, 15, 16, 17
NKBA03163	Pag 12, 16
NKBA03167	Pag 15, 16, 17
NKBA03328	Pag 15
NKBA03341	Pag 15, 17

Código/ Codigo/ PIN	Página/ Pagina/ Page
------------------------	----------------------------

**Veiculos de Passeio & Pick-ups / Vehiculos de Paseo y Camionet**

NKBA03826	Pag 16, 17
NKBA04332	Pag 15
NKBA04333	Pag 15, 17
NKBA04340	Pag 14, 15, 17, 18
NKBA05376	Pag 18
NKBA05608	Pag 19
NKBA05609	Pag 19
NKBA05610	Pag 19
NKBA06575	Pag 15, 17, 19
NKBA06576	Pag 13, 14
NKBA06577	Pag 13, 14, 16, 17
NKBA06578	Pag 13
NKBA07625	Pag 21
NKBA07626	Pag 20
NKBA07627	Pag 13, 14, 15, 20, 21
NKBA07628	Pag 14, 15, 20, 21
NKBA07629	Pag 20
NKBA07630	Pag 19, 20, 21
NKBA07631	Pag 21
NKBA07633	Pag 8, 20, 21
NKBA07636	Pag 20, 21
NKBA07640	Pag 20
NKBA08807	Pag 8, 18
NKBA08808	Pag 8, 18
NKBA089013	Pag 8, 18
NKBA089018	Pag 8, 18
NKBA09800	Pag 18, 19
NKBA09805	Pag 19
NKBA09813	Pag 19
NKBA09815	Pag 19
NKBA09820	Pag 19
NKBA12604	Pag 17
NKBA12605	Pag 17
NKBA12606	Pag 17
NKBA139003	Pag 8, 18
NKBA139012	Pag 18
NKBA16703	Pag 19
NKBA169009	Pag 19
NKBA169014	Pag 19
NKBA169019	Pag 19
NKBA17420	Pag 18
NKBA17421	Pag 18
NKBA179004	Pag 18

Código/ Codigo/ PIN	Página/ Pagina/ Page
------------------------	----------------------------

**Veiculos de Passeio & Pick-ups / Vehiculos de Paseo y Camionet**

NKBA189017	Pag 18
NKBA309002	Pag 18
NKBR03759	Pag 15, 17
NKBR04393	Pag 15, 17
NKBR05608	Pag 19
NKBR05709	Pag 19
NKBR06575	Pag 13
NKBR07391	Pag 15

**Motor / Motor / Engine**

NKBA02054	Pag 21
NKBA02092	Pag 22
NKBA02590	Pag 21
NKBA03128	Pag 22
NKBA03329	Pag 23
NKBA04318	Pag 23
NKBA04325	Pag 23
NKBA04326	Pag 23
NKBA04332	Pag 23
NKBA04333	Pag 22
NKBA04340	Pag 22
NKBA04553	Pag 23
NKBA04554	Pag 23
NKBA04560	Pag 23
NKBA05314	Pag 22
NKBA05316	Pag 22
NKBA05355	Pag 22
NKBA05362	Pag 22
NKBA05366	Pag 22, 23
NKBA05367	Pag 23
NKBA05368	Pag 23
NKBA05370	Pag 23
NKBA05372	Pag 23
NKBA05373	Pag 23
NKBA05374	Pag 23
NKBA05375	Pag 23
NKBA05380	Pag 23
NKBA05381	Pag 23
NKBA05608	Pag 22
NKBA05609	Pag 22
NKBA05610	Pag 22
NKBA06573	Pag 22
NKBA06574	Pag 22

Código/ Codigo/ PIN	Página/ Pagina/ Page
------------------------	----------------------------

**Motor / Motor / Engine**

NKBA06575	Pag 22
NKBA06576	Pag 22
NKBA06577	Pag 22
NKBA06578	Pag 22
NKBA06579	Pag 22
NKBA11980	Pag 23, 24
NKBA11981	Pag 23, 24
NKBA11982	Pag 23
NKBA11984	Pag 23
NKBR03759	Pag 22
NKBR04319	Pag 23
NKBR04392	Pag 23
NKBR04393	Pag 22
NKBR04554	Pag 23
NKBR04561	Pag 23
NKBR051313	Pag 22
NKBR051315	Pag 22
NKBR051356	Pag 22
NKBR051358	Pag 22
NKBR051364	Pag 22, 23
NKBR051371	Pag 23
NKBR051373	Pag 23
NKBR051374	Pag 23
NKBR051375	Pag 23
NKBR05608	Pag 22
NKBR05709	Pag 22
NKBR06575	Pag 22
NKBR07391	Pag 23
NKBR11983	Pag 23
NKBR11985	Pag 23

**Máquinas Agrícolas & Fora de Estrada / Vehiculos Fuera de Carr**

NKBA02054	Pag 25, 26, 28
NKBA03128	Pag 26
NKBA03135	Pag 25, 26, 29
NKBA03329	Pag 25, 26
NKBA04325	Pag 25, 27
NKBA04326	Pag 25, 26, 27
NKBA04553	Pag 25, 26
NKBA04554	Pag 25, 26, 27
NKBA04560	Pag 25
NKBA05314	Pag 24, 25, 26
NKBA05316	Pag 24, 26

Código/ Codigo/ PIN	Página/ Pagina/ Page
------------------------	----------------------------

**Máquinas Agrícolas & Fora de Estrada / Vehiculos Fuera de Carr**

NKBA05366	Pag 26
NKBA05608	Pag 25
NKBA06576	Pag 24, 25, 26, 27, 28
NKBA06578	Pag 24, 25, 26, 27, 28
NKBA11982	Pag 25
NKBA33582	Pag 24
NKBR03759	Pag 26
NKBR04392	Pag 25, 26
NKBR04554	Pag 25, 26, 27
NKBR04561	Pag 25
NKBR051313	Pag 24, 25, 26
NKBR051315	Pag 24, 26
NKBR051364	Pag 26
NKBR05608	Pag 25
NKBR06575	Pag 24, 25, 26, 27, 28
NKBR07391	Pag 25, 26, 27
NKBR11983	Pag 25
NKBR33478	Pag 24

**Caminhões & Ônibus / Camiones y Autobuses / Heavy Trucks &**

NKBA02054	Pag 31
NKBA02092	Pag 31
NKBA02590	Pag 29, 30
NKBA03128	Pag 31
NKBA04326	Pag 39
NKBA04332	Pag 31
NKBA04553	Pag 30, 31
NKBA04554	Pag 30, 31, 32
NKBA04560	Pag 31, 32
NKBA05314	Pag 32, 33, 34, 35
NKBA05316	Pag 32, 33, 34, 35
NKBA05355	Pag 33, 34, 36, 37
NKBA05362	Pag 32, 35, 36, 37
NKBA05366	Pag 32, 33, 34, 35, 36, 37
NKBA05369	Pag 36
NKBA05372	Pag 34, 36
NKBA05373	Pag 34, 36
NKBA05374	Pag 34, 35, 36
NKBA05375	Pag 34
NKBA05380	Pag 32, 33, 34, 35, 36, 37
NKBA05381	Pag 34, 35, 36, 37
NKBA05608	Pag 35
NKBA05609	Pag 35

Código/ Codigo/ PIN	Página/ Pagina/ Page
------------------------	----------------------------

**Caminhões & Ônibus / Camiones y Autobuses / Heavy Trucks &**

NKBA05610	Pag 35
NKBA06573	Pag 29, 38, 39
NKBA06574	Pag 39
NKBA06575	Pag 32
NKBA06576	Pag 29, 30, 31, 38, 39
NKBA06577	Pag 31
NKBA06578	Pag 29, 39
NKBA06579	Pag 31, 38, 39
NKBA10731	Pag 29, 30, 31, 38
NKBA10732	Pag 29, 30, 31, 38, 39
NKBA10733	Pag 29, 30, 31, 32, 33, 38, 39
NKBA10734	Pag 30, 38, 39
NKBA11980	Pag 37
NKBA11981	Pag 37, 38
NKBA11982	Pag 37
NKBA11984	Pag 37
NKBR03759	Pag 31
NKBR04554	Pag 30, 31, 32
NKBR04559	Pag 30, 31, 32
NKBR04561	Pag 31, 32
NKBR051313	Pag 32, 33, 34, 35
NKBR051315	Pag 32, 33, 34, 35
NKBR051356	Pag 33, 34, 36, 37
NKBR051358	Pag 34, 35, 36
NKBR051364	Pag 32, 33, 34, 35, 36, 37
NKBR051372	Pag 36
NKBR051373	Pag 34, 36
NKBR051374	Pag 34, 35, 36
NKBR051375	Pag 32, 33, 34, 35, 36, 37
NKBR05608	Pag 32, 35, 36, 37
NKBR05709	Pag 35
NKBR06575	Pag 29, 39
NKBR07391	Pag 31, 39
NKBR11983	Pag 37
NKBR11985	Pag 37
NKBR121100	Pag 39
NKBR14200	Pag 32
NKBR14202	Pag 32

**Anotações**

Notas  
Notes



A series of horizontal lines for writing notes, spaced evenly across the page.

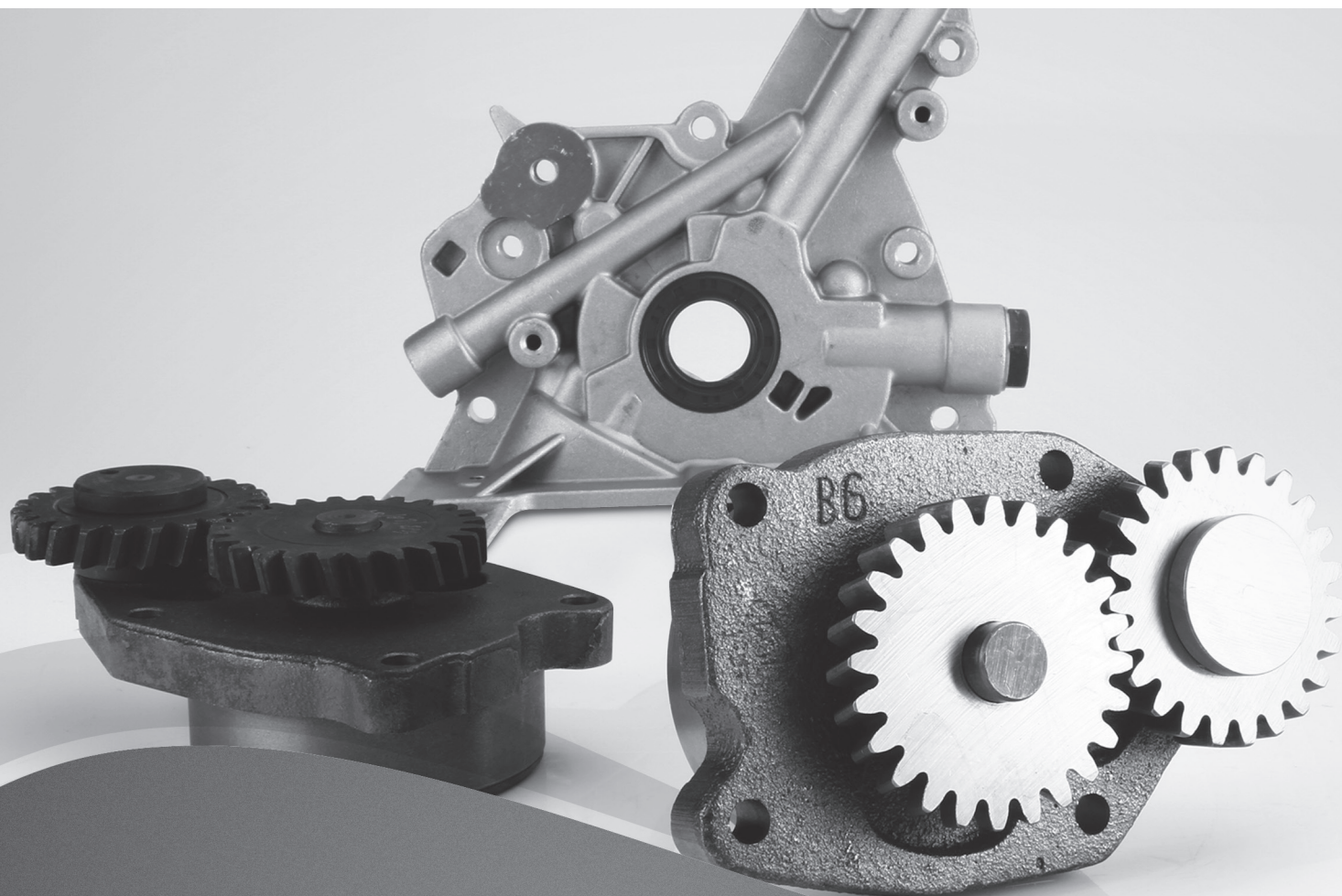

# BOMBAS DE ÓLEO

Bombas de Aceite / Oil Pumps

***Veículos: Leve e Pesado***  
***Vehículos: Liviano y Pesado***  
***Vehicles: Light and Heavy Duty***

<b>NAKATA</b>	<b>Descrição / Descripción / Description</b>		<b>Páginas / Paginas / Pages</b>
NKBO0155	Bomba de Óleo / Bomba de Aceite / Oil pump	FIAT 500 1.4 16V 01/10 12/11 Dianteiro / FIAT Bravo T-Jet 1.4 16V Turbo 01/12 12/16 Dianteiro / FIAT Linea T-Jet 1.4 16V Turbo 01/08 12/12 Dianteiro / FIAT Punto T-Jet 1.4 16V Turbo 01/08 12/16 Dianteiro	
NKBO0160	Bomba de Óleo / Bomba de Aceite / Oil pump	FIAT Bravo 1.8 E.Torq 16V 01/11 12/16 / FIAT Dobló 1.8 E.Torq 16V 01/11 12/16 / FIAT Grand Siena 1.6 E.Torq 16V 01/13 12/16 / FIAT Idea 1.6 E.Torq 16V 01/11 12/16 / FIAT Idea 1.8 E.Torq 16V 01/11 12/16 / FIAT Linea 1.8 E.Torq 16V 01/11 12/16 / FIAT Palio Novo 1.6 E.Torq 16V 01/11 12/16 / FIAT Palio Weekend 1.6 E.Torq 16V 01/11 12/16 / FIAT Palio Weekend 1.8 E.Torq 16V 01/11 12/16 / FIAT Punto 1.6 E.Torq 16V 01/11 12/16 / FIAT Punto 1.8 E.Torq 16V 01/11 12/16 / FIAT Siena 1.6 E.Torq 16V 01/11 12/16 / FIAT Strada 1.8 E.Torq 16V 01/11 12/16	
NKBO0350	Bomba de Óleo / Bomba de Aceite / Oil pump	GM Astra 2.4 16V 4 cil. 01/04 12/12 / GM Vectra 2.4 16V 4 cil. 01/06 12/12 / GM Zafira 2.4 16V 4 cil. 01/04 12/12	
NKBO0773	Bomba de Óleo / Bomba de Aceite / Oil pump	FORD F 250 4.2 TURBO 01/99 12/06 / GM Blazer 2.8 TURBO 01/00 12/12 / GM Grand Blazer SPRINT 4.2 TURBO 01/97 12/01 / GM S10 2.8 TURBO 01/00 12/12 / GM Silverado SPRINT 4.2 TURBO 01/97 12/01 / NISSAN Frontier 2.8 TURBO 01/02 12/07 / VW 5-140 EOD 4.07T 01/00 12/12 / VW 5-140 EOD 6.07T 01/00 12/12 / VW 8-150 EOD 4.07TCA 01/00 12/12 / VW 8-150 EOD 6.07TCA 01/00 12/12	
NKBO0805	Bomba de Óleo / Bomba de Aceite / Oil pump	CITROËN C 4 2.0 16V 01/09 12/16 Dianteiro / CITROËN C 5 2.0 16V 01/01 12/06 Dianteiro / CITROËN Xsara Picasso 2.0 16V 01/01 12/12 Dianteiro / PEUGEOT 307 2.0 16V 01/01 12/12 Dianteiro / PEUGEOT 308 2.0 16V 01/12 12/16 Dianteiro / PEUGEOT 404 2.0 16V 01/01 12/05 Dianteiro / PEUGEOT 407 2.0 16V 01/05 12/11 Dianteiro	
NKBO11000	Bomba de Óleo / Bomba de Aceite / Oil pump	TOYOTA Corolla 1.6 16V 01/02 12/08 Dianteiro / TOYOTA Corolla 1.8 16V 01/02 12/08 Dianteiro / TOYOTA Fielder 1.6 16V 01/02 12/08 Dianteiro / TOYOTA Fielder 1.8 16V 01/02 12/08 Dianteiro	

	Página/ Pagina/ Page
---	----------------------------

**Veiculos de Passeio & Pick-ups / Vehiculos de Paseo y Camionetas / Passenger Cars & Light Pick-ups**

AUDI	66
CITROËN	66
FIAT	66
FORD	69
GENERAL MOTORS	70
HONDA	74
MERCEDES BENZ	74
NISSAN	74
PEUGEOT	74
RENAULT	74
SEAT	75
TOYOTA	75
VOLKSWAGEN	75
	81

**Motor / Motor / Engine**

M.W.M.	81
MERCEDES BENZ	81
PERKINS	81
SCANIA	81

**Máquinas Agrícolas & Fora de Estrada / Vehiculos Fuera de Carretera / Off Highway**

AGCO	82
	81
CBT	82
ENGESA	82
FIAT ALLIS	82
FORD	82
IDEAL	82
	83
SANTA MATILDE	83
VALMET	83

**Caminhões & Ônibus / Camiones y Autobuses / Heavy Trucks & Buses**

AGRALE	84
	83
CHRYSLER	84
FORD	84
GENERAL MOTORS	86
IVECO	86
MERCEDES BENZ	86
SANTAL	90
SCANIA	90
VOLARE	91

	Página/ Pagina/ Page
--	----------------------------

VOLKSWAGEN - MAN	91
VOLVO	94

## Como utilizar este catálogo

Como usar el catálogo

How to use this catalog

# NAKATA®

Neste catálogo você encontrará todas as aplicações da linha de **Bombas Óleo NAKATA**. O catálogo está dividido em três tabelas e um índice por código.

**Aplicação por montadora e veículo:** localizada a partir da página 66 apresenta todas as aplicações de bombas de óleo, divididas de acordo com a montadora do veículo.

**Tabela de ilustração:** localizada a partir da página 95 facilita a identificação do produto desejado.

**Tabela de equivalência:** localizada a partir da página 101, mostra os códigos dos produtos que devem ser aplicados no lugar de modelos fornecidos pelas montadoras.

En este catálogo usted encontrará todas las aplicaciones de la línea de **Bombas de Oleo NAKATA**. El catálogo está dividido en tres tablas y un índice por código.

**Aplicación por marca y modelo:** esta tabla presenta todas las aplicaciones de bombas de oleo, dividida de acuerdo con la ensambladora del vehículo.

**Tabla de ilustraciones:** esta tabla presenta el dibujo de cada producto, para mejor identificación.

**Cruce de referencias:** esta tabla indica los códigos de intercambio con otras marcas de la competencia.

In this catalog, you will find all information about **NAKATA Oil Pumps**. This catalog is divided in three charts and one index code.

**Application by make and model:** this section presents all applications about pumps, divided according to the car maker.

**Illustrations chart:** this section presents the image of each product.

**Cross reference list:** this section presents all competitors cross reference part numbers, divided by competitors.

<b>Aplicação por Montadora e veículo / Bomba de Óleo</b> <b>Aplicación por marca y modelo / Bomba de Aceite</b> <b>Application by maker and model / Oil Pumps</b>						<b>NAKATA®</b>
						
Veículos de Passeio & Pick-ups / Vehículos de Paseo y Camionetas / Passenger Cars & Light Pick-ups						
<b>AUDI</b>						
100	2.0	01/90	12/94	NKBO0725	Engrenagem de 36mm / Engranaje de 36mm / 36mm Gear	
80	1.6 Diesel	01/80	12/89	NKBO0785*		
	1.6 Turbo Diesel	01/80	12/89	NKBO0785*		
	2.0	01/86	12/95	NKBO0725	Engrenagem de 36mm / Engranaje de 36mm / 36mm Gear	
90	1.6 Diesel	01/87	01/97	NKBO0785*		
	1.6 Turbo Diesel	01/87	01/97	NKBO0785*		
A3	1.6 8V (EA111) 4 Cil	08/99	06/01	NKBO0700		
	1.6 8V (EA113) 4 Cil	07/99	12/07	NKBO0787		
	1.8T 150cv 4 Cil	01/99	12/07	NKBO0787		
	1.8T 180cv 4 Cil	01/99	12/07	NKBO0787		
A6	2.0	01/94	12/97	NKBO0725	Engrenagem de 36mm / Engranaje de 36mm / 36mm Gear	
<b>CITROËN</b>						
C 3	1.4 8V 4 Cil	01/05	12/12	NKBO0804		
	1.6 16V 4 Cil	01/02	12/13	NKBO0801		
C 4	2.0 16V 4 Cil	01/09	12/15	NKBO0805		
C 5	2.0 16V 4 Cil	01/01	12/06	NKBO0805		



## Como utilizar este catálogo

Como usar el catálogo

How to use this catalog

# NAKATA®

A estrutura das tabelas é similar, apresentando as seguintes informações:

La estructura de las tablas es similar, presentando las siguientes informaciones:

The structure from the tables is similar, presenting the following information:

- A O tipo de tabela /  
Descripción de la tabla /  
Section description
- B Montadora do veículo /  
Ensambladora del vehículo /  
Carmaker
- C Veículo / Vehículo / Vehicle
- D Motor / Motor / Engine
- E Ano (Ano inicial/Ano final) /  
Año (Año inicial/Año final) /  
Year (Start year/End year)
- F Bomba de óleo / Bomba de aceite / Oil pump
- G Observação / Observación / Remark

### Tabela de ilustrações / Bombas de óleo

Tabla de ilustraciones / Bombas de aceite

Illustrations chart / Oil Pumps

# NAKATA®

NKBO0100



NKBO0105



NKBO0110

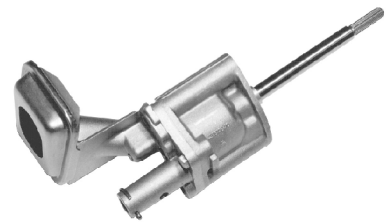

NKBO0115

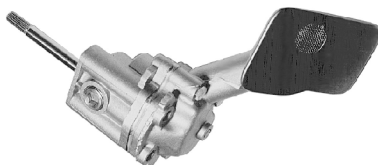

NKBO0120

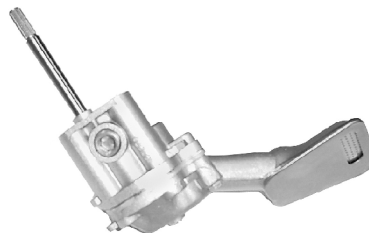

NKBO0130



Tabela de Equivalência / Bomba de Óleo AM  
Cruce de Referencias / Bomba de Aceite AM  
Cross Reference List / Oil Pumps AM

# NAKATA®

#ANROI		#NAKAT		#ANROI		#NAKAT		#SCHADEK	
AR1000	NKBO0715	AT8020	NKBO0235	10175					NKBO0797
AR1065	NKBO0710	AT8021	NKBO0789	10179					NKBO0771
AR1100	NKBO0720	AT9020	NKBO0420	10182A					NKBO0787
AR3020	NKBO0695	AT9021	NKBO0425	10189HD					NKBO0420
AR3060	NKBO0229			10189					NKSO0148
AR3070				10189					NKBO0140
AR4030	NKBO0405			10192					NKBO0904
AR4040	NKBO0400	10003	NKBO0705	10193					NKBO0993
AR5010	NKBO0500	10010	NKBO0710	10194					NKBO0902
AR5020	NKBO0530	10013	NKBO0320	10195					NKBO0740
AR6010	NKBO0600	10017	NKBO0325	10197					NKBO0704
AR7010	NKBO0100	10021	NKBO0400	10199					NKBO0343
AR7030	NKBO0105	10025	NKBO0100	10206					NKBO0331
AT1035	NKBO0705	10028	NKBO0715	10210					NKBO0202
AT1121	NKBO0750	10052	NKBO0105	10210A					NKBO0200
AT1200	NKBO0725	10053	NKBO0600	10215					NKBO0525
AT1250	NKBO0735	10054	NKBO0315	10216					NKBO0540
AT1251	NKBO0735	10055	NKBO0205	10217					NKBO0410

Índice por código / Bomba de Óleo  
Indice por código / Bomba de Aceite  
Index by P/Nh / Oil Pumps

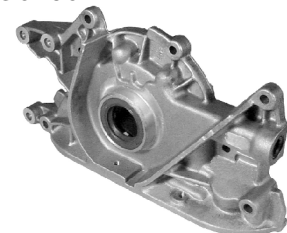
# NAKATA®

Código/ Codigo/ PIN	Página/ Pagina/ Page	Código/ Codigo/ PIN	Página/ Pagina/ Page
<b>Caminhões &amp; Ônibus / Camiones y Autobuses / Heavy Trucks &amp;</b>		<b>Veículos de Passeio &amp; Pick-ups / Vehículos de Paseo y Camionet</b>	
NKBO0230	Pag 83	NKBO1005	Pag 64, 65, 66
NKBO0235	Pag 83	NKBO1110	Pag 64, 65, 66
NKBO0400	Pag 82, 83, 84, 90	NKBO1115	Pag 64, 65, 66
NKBO0410	Pag 87, 88	NKBO1200	Pag 64, 65, 66
NKBO0420	Pag 87, 88	NKBO1300	Pag 66
NKBO0425	Pag 88	NKBO1335	Pag 66
NKBO0500	Pag 84, 85, 86, 87	NKBO1338	Pag 66
NKBO0505	Pag 84, 85, 86, 87	NKBO1400	Pag 64, 65, 66
NKBO0510	Pag 84, 85, 86, 87	NKBO1445	Pag 64, 65, 66
NKBO0520	Pag 85, 86, 87	NKBO1500	Pag 64, 65, 66
NKBO0530	Pag 86, 87	NKBO0200	Pag 66, 67
NKBO0535	Pag 86, 87	NKBO0202	Pag 66, 67

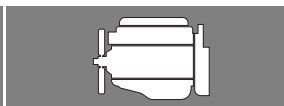

**Veículos de Passeio & Pick-ups / Vehiculos de Paseo y Camionetas / Passenger Cars & Light Pick-ups**

**AUDI**

100	2.0	01/90	12/94	<b>NKBO0725</b>	Engrenagem de 36mm / Engranaje de 36mm / 36mm Gear
80	1.6 Diesel	01/80	12/89	<b>NKBO0785*</b>	
	1.6 Turbo Diesel	01/80	12/89	<b>NKBO0785*</b>	
	2.0	01/86	12/95	<b>NKBO0725</b>	Engrenagem de 36mm / Engranaje de 36mm / 36mm Gear
90	1.6 Diesel	01/87	01/97	<b>NKBO0785*</b>	
	1.6 Turbo Diesel	01/87	01/97	<b>NKBO0785*</b>	
A3	1.6 8V (EA111) 4 Cil	08/99	06/01	<b>NKBO0700</b>	
	1.6 8V (EA113) 4 Cil	07/99	12/07	<b>NKBO0787</b>	
	1.8T 150cv 4 Cil	01/99	12/07	<b>NKBO0787</b>	
	1.8T 180cv 4 Cil	01/99	12/07	<b>NKBO0787</b>	
A6	2.0	01/94	12/97	<b>NKBO0725</b>	Engrenagem de 36mm / Engranaje de 36mm / 36mm Gear

**CITROËN**

C 3	1.4 8V 4 Cil	01/05	12/12	<b>NKBO0804</b>	
	1.6 16V 4 Cil	01/02	12/13	<b>NKBO0801</b>	
C 4	2.0 16V 4 Cil	01/09	12/16	<b>NKBO0805</b>	
C 5	2.0 16V 4 Cil	01/01	12/06	<b>NKBO0805</b>	
Xsara	1.6 16V	01/98	12/03	<b>NKBO0801</b>	
	1.8 16V	01/98	12/03	<b>NKBO0802</b>	
	2.0 16V	01/98	12/03	<b>NKBO0802</b>	
	2.0 16V 4 Cil	01/01	12/12	<b>NKBO0805</b>	

**FIAT**

128	MWM D229 6 Cil	01/83	12/86	<b>NKBO0600</b>	
147	1.050 4 Cil	01/77	12/86	<b>NKBO0100</b>	
	1.3 4 Cil	01/77	12/86	<b>NKBO0105</b>	
	1.5 4 Cil	01/77	12/86	<b>NKBO0105</b>	
500	1.4 16V 4 Cil	01/10	12/11	<b>NKBO0155</b>	
	1.4 Fire Flex 4 Cil	01/12	12/16	<b>NKBO0140</b>	
Brava	1.6 MFI 16V 4 Cil	01/00	12/03	<b>NKBO0120</b>	
Bravo	1.4 16V Turbo 4 Cil	01/12	12/16	<b>NKBO0155</b>	
	1.8 E.Torq 16V 4 Cil	01/11	12/16	<b>NKBO0160</b>	
Dobló	1.3 16V Fire 4 Cil	01/02	12/09	<b>NKBO0140</b>	
	1.4 8V Fire 4 Cil	01/06	12/16	<b>NKBO0150</b>	
	1.8 16V 4 Cil	01/02	12/10	<b>NKBO0333</b>	
	1.8 8V 4 Cil	01/02	12/10	<b>NKBO0335</b>	
	1.8 E.Torq 16V 4 Cil	01/11	12/16	<b>NKBO0160</b>	
Duna	1.6 Sevel	01/88	12/98	<b>NKBO0115</b>	
Elba	1.3	01/87	12/91	<b>NKBO0105</b>	
	1.5	01/91	12/96	<b>NKBO0110</b>	
	1.5 Sevel	01/87	12/89	<b>NKBO0115</b>	
	1.6 Sevel	01/90	12/95	<b>NKBO0115</b>	
Fiorino	1.0 4 Cil	01/94	12/96	<b>NKBO0105</b>	Exceto Motor Fire / Excepto Motor Fire / Except Engine model Fire



**Veículos de Passeio & Pick-ups / Vehiculos de Paseo y Camionetas / Passenger Cars & Light Pick-ups**

**FIAT**

Fiorino	1.050 4 Cil	01/85	12/86	<b>NKBO0100</b>	
	1.3 4 Cil	01/85	12/86	<b>NKBO0105</b>	
	1.3 8V Fire 4 Cil	01/03	12/06	<b>NKBO0145</b>	
	1.5 4 Cil	01/89	12/98	<b>NKBO0110</b>	
	1.6 Sevel 4 Cil	01/92	12/96	<b>NKBO0115</b>	
Grand Siena	1.4 Fire Evo 4 Cil	01/12	12/16	<b>NKBO0140</b>	
	1.6 E.Torq 16V 4 Cil	01/13	12/16	<b>NKBO0160</b>	
Idea	1.4 8V Fire 4 Cil	01/06	12/16	<b>NKBO0150</b>	
	1.6 E.TORQ 16V 4 Cil	01/11	12/16	<b>NKBO0160</b>	
	1.8 8V 4 Cil	01/06	12/10	<b>NKBO0335</b>	
	1.8 E.TORQ 16V 4 Cil	01/11	12/16	<b>NKBO0160</b>	
Linea	1.4 16V Turbo 4 Cil	01/08	12/12	<b>NKBO0155</b>	
	1.8 E.Torq 16V 4 Cil	01/11	12/16	<b>NKBO0160</b>	
Oggi	1.3	01/77	12/86	<b>NKBO0105</b>	
Palio	1.0 16V Fire 4 Cil	01/01	12/03	<b>NKBO0140</b>	
	1.0 8V 4 Cil	01/96	12/00	<b>NKBO0105</b>	Exceto Motor Fire / Excepto Motor Fire / Except Engine model Fire
	1.0 8V Fire 4 Cil	01/01	12/09	<b>NKBO0145</b>	
	1.0 8V Fire 4 Cil	01/01	12/16	<b>NKBO0145</b>	
	1.3 16V Fire 4 Cil	01/01	12/09	<b>NKBO0140</b>	
	1.3 8V Fire 4 Cil	01/03	12/14	<b>NKBO0145</b>	
	1.4 8V Fire 4 Cil	01/06	12/09	<b>NKBO0145</b>	(Até o chassi 2.616.995)
	1.4 8V Fire 4 Cil	01/06	12/16	<b>NKBO0150</b>	A partir do chassi 2.616.996
	1.5 8V 4 Cil	01/96	12/98	<b>NKBO0110</b>	
	1.6 16V 4 Cil	01/96	12/06	<b>NKBO0120</b>	Exceto Motor Step B / Excepto Motor Step B / Except Engine model Step B
	1.6 E.Torq 16V 4 Cil	01/11	12/16	<b>NKBO0160</b>	
Palio Novo	1.0 Fire Evo 4 Cil	01/06	12/16	<b>NKBO0145</b>	
	1.4 Fire Evo 4 Cil	01/06	12/16	<b>NKBO0140</b>	
Palio Weekend	1.0 16V Fire 4 Cil	01/01	12/03	<b>NKBO0140</b>	
	1.0 8V 4 Cil	01/96	12/00	<b>NKBO0105</b>	
	1.3 16V Fire 4 Cil	01/01	12/09	<b>NKBO0140</b>	
	1.3 8V Fire 4 Cil	01/03	12/09	<b>NKBO0145</b>	
	1.4 8V Fire 4 Cil	01/06	12/09	<b>NKBO0145</b>	(Até o chassi 4.145.005)
	1.4 8V Fire 4 Cil	01/06	12/16	<b>NKBO0150</b>	A partir do chassi 4.145.006
	1.5 8V 4 Cil	01/96	12/98	<b>NKBO0110</b>	
	1.6 16V 4 Cil	01/96	12/06	<b>NKBO0120</b>	Exceto Motor Step B / Excepto Motor Step B / Except Engine model Step B
	1.6 E.Torq 16V 4 Cil	01/11	12/16	<b>NKBO0160</b>	
	1.8 8V 4 Cil	01/03	12/10	<b>NKBO0335</b>	
Panorama	1.050 4 Cil	01/77	12/86	<b>NKBO0100</b>	
	1.5	01/89	12/93	<b>NKBO0110</b>	

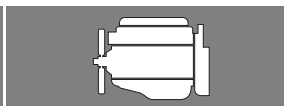

**Veículos de Passeio & Pick-ups / Vehiculos de Paseo y Camionetas / Passenger Cars & Light Pick-ups**

**FIAT**

Premio	1.5 Sevel	01/85	12/89	<b>NKBO0115</b>	
	1.6 Sevel	01/90	12/93	<b>NKBO0115</b>	
Punto	1.4 16V Turbo 4 Cil	01/08	12/16	<b>NKBO0155</b>	
	1.4 8V Fire 4 Cil	01/08	12/16	<b>NKBO0150</b>	
	1.4 Fire Flex 4 Cil	01/13	12/16	<b>NKBO0140</b>	
	1.6 E.Torq 16V 4 Cil	01/11	12/16	<b>NKBO0160</b>	
	1.8 E.Torq 16V 4 Cil	01/11	12/16	<b>NKBO0160</b>	
Siena	1.0 16V Fire 4 Cil	01/01	12/03	<b>NKBO0140</b>	
	1.0 8V 4 Cil	01/98	12/00	<b>NKBO0105</b>	Exceto Motor Fire / Excepto Motor Fire / Except Engine model Fire
	1.0 8V 4 Cil	01/99	12/00	<b>NKBO0110</b>	6 Marchas / 6 Marchas / 6 Gear
	1.0 8V Fire 4 Cil	01/02	12/16	<b>NKBO0145</b>	
	1.3 16V Fire 4 Cil	01/01	12/09	<b>NKBO0140</b>	
	1.3 8V Fire 4 Cil	01/03	12/14	<b>NKBO0145</b>	
	1.4 8V Fire 4 Cil	01/06	12/16	<b>NKBO0150</b>	A partir do chassi 3.173.466
	1.4 8V Fire 4 Cil	01/06	12/14	<b>NKBO0145</b>	(Até o chassi 3.173.465)
	1.5 8V 4 Cil	01/99	12/02	<b>NKBO0110</b>	6 Marchas / 6 Marchas / 6 Gear
	1.6 16V 4 Cil	01/97	12/99	<b>NKBO0120</b>	Exceto Motor Step B / Excepto Motor Step B / Except Engine model Step B
	1.6 E.Torq 16V 4 Cil	01/11	12/16	<b>NKBO0160</b>	
1.8 8V 4 Cil	01/02	12/10	<b>NKBO0335</b>		
Stilo	1.8 16V 4 Cil	01/03	12/07	<b>NKBO0333</b>	
	1.8 8V 4 Cil	01/03	12/11	<b>NKBO0335</b>	
Strada	1.3 8V Fire 4 Cil	01/03	12/06	<b>NKBO0145</b>	
	1.4 8V Fire 4 Cil	01/06	12/06	<b>NKBO0145</b>	(Até o chassi 2.468.755)
	1.4 8V Fire 4 Cil	01/06	12/16	<b>NKBO0150</b>	A partir do chassi 2.468.756
	1.5 8V 4 Cil	01/99	12/02	<b>NKBO0110</b>	
	1.6 16V 4 Cil	01/98	12/06	<b>NKBO0120</b>	Exceto Motor Step B / Excepto Motor Step B / Except Engine model Step B
	1.8 8V 4 Cil	01/02	12/10	<b>NKBO0335</b>	
1.8 E.Torq 16V 4 Cil	01/11	12/16	<b>NKBO0160</b>		
Tempra	2.0 16V 4 Cil	01/93	12/99	<b>NKBO0130</b>	
	2.0 8V 4 Cil	01/92	02/94	<b>NKBO0136</b>	
	2.0 8V 4 Cil	03/94	12/99	<b>NKBO0135</b>	
	2.0 8V Turbo 4 Cil	01/93	12/99	<b>NKBO0130</b>	
Tipo	1.6 Sevel	01/96	12/97	<b>NKBO0115</b>	
Uno	1.0 4 Cil	01/91	12/00	<b>NKBO0105</b>	
	1.0 4 Cil	01/99	12/06	<b>NKBO0110</b>	Exceto Motor Fire / Excepto Motor Fire / Except Engine model Fire
	1.0 8V Fire 4 Cil	01/02	12/16	<b>NKBO0145</b>	
	1.3 4 Cil	01/85	12/91	<b>NKBO0105</b>	
	1.3 8V Fire 4 Cil	01/03	12/08	<b>NKBO0145</b>	
	1.4 EVO 4 Cil	01/11	12/16	<b>NKBO0140</b>	
	1.5 4 Cil	01/89	12/96	<b>NKBO0110</b>	
	1.5 Sevel 4 Cil	01/85	12/91	<b>NKBO0115</b>	
	1.6 Sevel 4 Cil	01/90	12/94	<b>NKBO0115</b>	



**Veículos de Passeio & Pick-ups / Vehiculos de Paseo y Camionetas / Passenger Cars & Light Pick-ups**

**FIAT**

Uno Novo	1.0 Fire Evo 4 Cil	01/11	12/16	<b>NKBO0145</b>	
	1.4 Fire Evo 4 Cil	01/11	12/16	<b>NKBO0140</b>	

**FORD**

Belina	1.3 4 Cil	01/75	12/78	<b>NKBO0205</b>	
	1.4 CHT 4 Cil	01/75	12/78	<b>NKBO0205</b>	
	1.6 CHT 4 Cil	01/78	12/89	<b>NKBO0210</b>	
	1.8 AP 8V 4 Cil	01/89	12/91	<b>NKBO0725</b>	Engrenagem de 36mm / Engranaje de 36mm / 36mm Gear
Corcel I	1.3 4 Cil	01/69	12/78	<b>NKBO0205</b>	
	1.4 CHT 4 Cil	01/69	12/78	<b>NKBO0205</b>	
Corcel II	1.6 CHT 4 Cil	01/78	12/86	<b>NKBO0210</b>	
Courier	1.3 Endura 4 Cil	01/97	01/99	<b>NKBO0203</b>	
	1.6 Zetec Rocan 4 Cil	01/03	12/09	<b>NKBO0202</b>	Sem Polia / Sin Polea / Without Pulley
	1.6 Zetec Rocan 4 Cil	01/99	12/02	<b>NKBO0200</b>	
Del Rey	1.6 CHT	01/81	12/91	<b>NKBO0210</b>	
	1.8 AP 8V	01/89	12/91	<b>NKBO0725</b>	Engrenagem de 36mm / Engranaje de 36mm / 36mm Gear
EcoSport	1.0 8V Supercharger 4 Cil	01/03	12/06	<b>NKBO0201</b>	Polia Dupla
	1.0 SuperCharger 4 Cil	01/03	12/10	<b>NKBO0202</b>	Sem Polia / Sin Polea / Without Pulley
	1.0 Zetec Rocan 4 Cil	01/03	12/10	<b>NKBO0200</b>	Exceto Supercharger / Excepto Motor Supercharger / Except Supercharger Engine
	1.6 Zetec Rocan 4 Cil	01/03	06/12	<b>NKBO0202</b>	Sem Polia / Sin Polea / Without Pulley
	1.6 Zetec Rocan 4 Cil	01/03	06/12	<b>NKBO0200</b>	
	2.0 8V Duratec 4 Cil	01/03	12/11	<b>NKBO0225</b>	
Escort	2.0 8V Duratec 4 Cil	01/12	12/16	<b>NKBO0225</b>	
	1.6 AP 4 Cil	01/93	12/96	<b>NKBO0730</b>	Engrenagem de 36mm, Com Defletor de Óleo / Engranaje de 36mm Con Deflector de Aceite / 3mm Gear with Oil Deflector
	1.6 CHT 4 Cil	01/83	12/96	<b>NKBO0215</b>	
Escort Hobby	1.8 AP 4 Cil	01/93	12/96	<b>NKBO0730</b>	Engrenagem de 36mm, Com Defletor de Óleo / Engranaje de 36mm Con Deflector de Aceite / 3mm Gear with Oil Deflector
	1.0 CHT 4 Cil	01/93	12/96	<b>NKBO0215</b>	
Escort Sedan	1.6 CHT 4 Cil	01/93	12/96	<b>NKBO0215</b>	
	1.8 Zetec	01/97	12/02	<b>NKBO0245</b>	
Escort SW	2.0 Zetec	01/97	12/02	<b>NKBO0245</b>	
	1.8 Zetec	01/97	12/02	<b>NKBO0245</b>	
F 1000	2.5 HSD TURBO Diesel	01/96	12/98	<b>NKBO0343</b>	
F 350	3.9 Diesel	01/98	01/05	<b>NKBO0235</b>	Altura do rotor 12,20 mm
Fiesta	1.0 8V Supercharger 4 Cil	01/03	12/14	<b>NKBO0201</b>	Polia Dupla
	1.0 Endura 4 Cil	01/96	01/99	<b>NKBO0203</b>	
	1.0 Supercharger 4 Cil	01/03	12/14	<b>NKBO0202</b>	Sem Polia / Sin Polea / Without Pulley
	1.0 Zetec Rocan 4 Cil	01/03	12/14	<b>NKBO0202</b>	Sem Polia / Sin Polea / Without Pulley
	1.0 Zetec Rocan 4 Cil	01/99	12/14	<b>NKBO0200</b>	Exceto Supercharger / Excepto Motor Supercharger / Except Supercharger Engine
	1.3 Endura 4 Cil	01/96	12/98	<b>NKBO0203</b>	
	1.6 Zetec Rocan 4 Cil	01/03	12/13	<b>NKBO0202</b>	Sem Polia / Sin Polea / Without Pulley

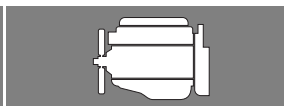

**Veículos de Passeio & Pick-ups / Vehiculos de Paseo y Camionetas / Passenger Cars & Light Pick-ups**

**FORD**

Fiesta	1.6 Zetec Rocan 4 Cil	01/99	12/13	<b>NKBO0200</b>	
Fiesta Sedan	1.0 Supercharger 4 Cil	01/04	12/10	<b>NKBO0202</b>	Sem Polia / Sin Polea / Without Pulley
	1.0 Zetec Rocan 4 Cil	01/03	12/13	<b>NKBO0202</b>	Sem Polia / Sin Polea / Without Pulley
	1.6 Zetec Rocan 4 Cil	01/03	12/13	<b>NKBO0202</b>	Sem Polia / Sin Polea / Without Pulley
Focus	1.6 Zetec Rocan 4 Cil	01/04	12/09	<b>NKBO0202</b>	Sem Polia / Sin Polea / Without Pulley
	1.6 Zetec Rocan 4 Cil	01/04	12/09	<b>NKBO0200</b>	
	2.0 8V Duratec 4 Cil	01/05	12/08	<b>NKBO0225</b>	
Jeep	2.3 4 Cil	01/75	12/83	<b>NKBO0220</b>	
Ka	1.0 Endura 4 Cil	01/97	01/99	<b>NKBO0203</b>	
	1.0 Zetec Rocan 4 Cil	01/03	12/14	<b>NKBO0202</b>	Sem Polia / Sin Polea / Without Pulley
	1.0 Zetec Rocan 4 Cil	09/99	12/02	<b>NKBO0200</b>	
	1.3 Endura 4 Cil	01/97	01/99	<b>NKBO0203</b>	
	1.6 Zetec Rocan 4 Cil	01/03	12/13	<b>NKBO0202</b>	Sem Polia / Sin Polea / Without Pulley
	1.6 Zetec Rocan 4 Cil	09/99	12/02	<b>NKBO0200</b>	
Maverick	2.3 4 Cil	01/75	12/79	<b>NKBO0220</b>	
Mondeo	2.0 8V Duratec 4 Cil	01/01	12/07	<b>NKBO0225</b>	
Pampa	1.6 CHT	01/82	12/96	<b>NKBO0210</b>	
	1.8 AP 8V	01/90	12/97	<b>NKBO0725</b>	Engrenagem de 36mm / Engranaje de 36mm / 36mm Gear
Ranger	2.3 Duratec 4 Cil	01/01	12/08	<b>NKBO0225</b>	
	2.5 Diesel	01/98	12/01	<b>NKBO0343</b>	
	2.8 Diesel	01/98	12/01	<b>NKBO0343</b>	
Royale	1.8 AP 8V	01/92	12/97	<b>NKBO0725</b>	Engrenagem de 36mm / Engranaje de 36mm / 36mm Gear
	2.0 AP 8V	01/92	12/97	<b>NKBO0725</b>	Engrenagem de 36mm / Engranaje de 36mm / 36mm Gear
Verona	1.6 CHT	01/90	12/92	<b>NKBO0215</b>	
Versailles	1.8 AP 8V	01/92	12/96	<b>NKBO0725</b>	Engrenagem de 36mm / Engranaje de 36mm / 36mm Gear
	2.0 AP 8V	01/92	12/96	<b>NKBO0725</b>	Engrenagem de 36mm / Engranaje de 36mm / 36mm Gear

**GENERAL MOTORS**

A/C/D 10	Maxion S4 4 Cil Diesel	01/79	12/90	<b>NKBO0400</b>	
	Perkins 4236 4 Cil Diesel	01/79	12/91	<b>NKBO0400</b>	
A/C/D 20	4.1 4 Cil	01/85	12/96	<b>NKBO0325</b>	Corpo em Alumínio Injetado / Cuerpo de Aluminio Inyectado / Injected Aluminum Body
	Maxion S4 4 Cil Diesel	01/88	12/96	<b>NKBO0400</b>	
	Perkins 4236 4 Cil Diesel	01/79	12/91	<b>NKBO0400</b>	
Agile	1.4 8V 4 Cil	01/10	12/14	<b>NKBO0300</b>	
Astra	1.8 8V 4 Cil	01/99	12/02	<b>NKBO0340</b>	Rosca de 8 mm para fixação do carter / Thread with 8 mm to fix in the carter
	1.8 8V 4 Cil	01/99	12/02	<b>NKBO0305</b>	Rosca de 6 mm para fixação do carter / Thread with 6 mm to fix in the carter
	2.0 16V 4 Cil	01/95	12/10	<b>NKBO0340</b>	Rosca de 8 mm para fixação do carter / Thread with 8 mm to fix in the carter
	2.0 16V 4 Cil	01/99	12/10	<b>NKBO0330</b>	
	2.0 8V 4 Cil	01/95	12/12	<b>NKBO0305</b>	Rosca de 6 mm para fixação do carter / Thread with 6 mm to fix in the carter

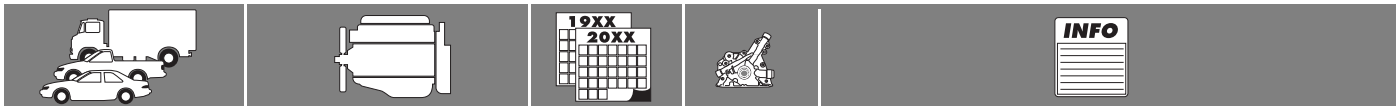

**Veículos de Passeio & Pick-ups / Vehiculos de Paseo y Camionetas / Passenger Cars & Light Pick-ups**

**GENERAL MOTORS**

Astra	2.0 8V 4 Cil	01/95	12/12	<b>NKBO0340</b>	Rosca de 8 mm para fixação do carter / Thread with 8 mm to fix in the carter
	2.4 16V 4 Cil	01/04	12/12	<b>NKBO0350</b>	
Blazer	2.8 TURBO	01/00	12/12	<b>NKBO0773</b>	
	2.2 EFI 4 Cil	01/96	12/99	<b>NKBO0305</b>	Rosca de 6 mm para fixação do carter / Thread with 6 mm to fix in the carter
	2.4 MPFI 4 Cil	01/01	12/11	<b>NKBO0305</b>	Rosca de 6 mm para fixação do carter / Thread with 6 mm to fix in the carter
	2.4 MPFI 4 Cil	01/01	12/11	<b>NKBO0340</b>	Rosca de 8 mm para fixação do carter / Thread with 8 mm to fix in the carter
	2.5 4 Cil Diesel	01/96	12/00	<b>NKBO0343</b>	
Bonanza	4.1	01/91	12/94	<b>NKBO0325</b>	Corpo em Alumínio Injetado / Cuerpo de Aluminio Inyectado / Injected Aluminum Body
Caravan GM	2.5	01/75	12/92	<b>NKBO0325</b>	Corpo em Alumínio Injetado / Cuerpo de Aluminio Inyectado / Injected Aluminum Body
	4.1	01/75	12/92	<b>NKBO0325</b>	Corpo em Alumínio Injetado / Cuerpo de Aluminio Inyectado / Injected Aluminum Body
Celta	1.0 8V 4 Cil	01/00	12/15	<b>NKBO0300</b>	
	1.4 8V 4 Cil	01/03	12/14	<b>NKBO0300</b>	
Chevette	1.0	01/73	12/93	<b>NKBO0320</b>	Tampa em Alumínio Injetado / Tapa de Aluminio inyectado / Injected Aluminum Cover
	1.4	01/73	12/93	<b>NKBO0320</b>	Tampa em Alumínio Injetado / Tapa de Aluminio inyectado / Injected Aluminum Cover
	1.6	01/73	12/93	<b>NKBO0320</b>	Tampa em Alumínio Injetado / Tapa de Aluminio inyectado / Injected Aluminum Cover
Chevy 500	1.4	01/84	12/95	<b>NKBO0320</b>	Tampa em Alumínio Injetado / Tapa de Aluminio inyectado / Injected Aluminum Cover
	1.6	01/84	12/95	<b>NKBO0320</b>	Tampa em Alumínio Injetado / Tapa de Aluminio inyectado / Injected Aluminum Cover
Corsa	1.0 16V 4 Cil	01/94	12/01	<b>NKBO0300</b>	
	1.0 8V 4 Cil	01/94	12/01	<b>NKBO0300</b>	
	1.0 VHC 4 Cil	01/02	12/12	<b>NKBO0300</b>	
	1.4 8V 4 Cil	01/07	12/12	<b>NKBO0300</b>	
	1.4 8V 4 Cil	01/94	12/98	<b>NKBO0300</b>	
	1.6 16V 4 Cil	01/94	12/09	<b>NKBO0300</b>	
	1.6 8V 4 Cil	01/94	12/09	<b>NKBO0300</b>	
	1.8 8V 4 Cil	01/02	12/04	<b>NKBO0331</b>	
	1.8 8V 4 Cil	01/05	12/12	<b>NKBO0335</b>	
Corsa Classic	1.0 16V 4 Cil	01/96	12/02	<b>NKBO0300</b>	
	1.0 8V 4 Cil	01/96	12/02	<b>NKBO0300</b>	
	1.0 VHC 4 Cil	01/02	12/14	<b>NKBO0300</b>	
	1.6 16V 4 Cil	01/96	12/02	<b>NKBO0300</b>	
	1.6 8V 4 Cil	01/96	12/09	<b>NKBO0300</b>	
Corsa Pick-up	1.6 8V 4 Cil	01/95	12/03	<b>NKBO0300</b>	
Corsa Wagon	1.0 16V 4 Cil	01/97	12/02	<b>NKBO0300</b>	
	1.0 8V 4 Cil	01/97	12/02	<b>NKBO0300</b>	
	1.6 16V 4 Cil	01/97	12/02	<b>NKBO0300</b>	

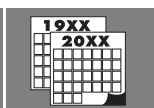
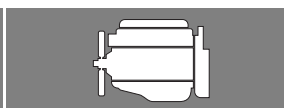

**Veículos de Passeio & Pick-ups / Vehiculos de Paseo y Camionetas / Passenger Cars & Light Pick-ups**

**GENERAL MOTORS**

Corsa Wagon	1.6 8V 4 Cil	01/97	12/02	<b>NKBO0300</b>	
Cruze	1.8 16V ECOTEC	01/12	12/16	<b>NKBO0345</b>	
D20	Perkins 4236 4 Cil	01/85	12/95	<b>NKBO0400</b>	
Grand Blazer	SPRINT 4.2 TURBO	01/97	12/01	<b>NKBO0773</b>	
	4.1	01/98	12/99	<b>NKBO0325</b>	Corpo em Alumínio Injetado / Cuerpo de Aluminio Inyectado / Injected Aluminum Body
Ipanema	1.8 8V	01/87	12/97	<b>NKBO0310</b>	
	1.8 8V 4 Cil	01/97	12/98	<b>NKBO0340</b>	Rosca de 8 mm para fixação do carter / Thread with 8 mm to fix in the carter
	2.0 8V	01/87	12/97	<b>NKBO0310</b>	
	2.0 8V 4 Cil	01/97	12/98	<b>NKBO0340</b>	Rosca de 8 mm para fixação do carter / Thread with 8 mm to fix in the carter
	2.0 8V 4 Cil	01/97	12/98	<b>NKBO0305</b>	Rosca de 6 mm para fixação do carter / Thread with 6 mm to fix in the carter
	2.2 8V 4 Cil	01/97	12/98	<b>NKBO0340</b>	Rosca de 8 mm para fixação do carter / Thread with 8 mm to fix in the carter
Kadett	1.8 8V	01/87	12/97	<b>NKBO0310</b>	
	1.8 8V 4 Cil	01/97	12/98	<b>NKBO0340</b>	Rosca de 8 mm para fixação do carter / Thread with 8 mm to fix in the carter
	2.0 8V	01/87	12/97	<b>NKBO0310</b>	
	2.0 8V 4 Cil	01/97	12/98	<b>NKBO0305</b>	Rosca de 6 mm para fixação do carter / Thread with 6 mm to fix in the carter
	2.0 8V 4 Cil	01/97	12/98	<b>NKBO0340</b>	Rosca de 8 mm para fixação do carter / Thread with 8 mm to fix in the carter
Marajó	1.4 8V	01/81	12/90	<b>NKBO0320</b>	Tampa em Alumínio Injetado / Tapa de Aluminio inyectado / Injected Aluminum Cover
	1.6 8V	01/81	12/90	<b>NKBO0320</b>	Tampa em Alumínio Injetado / Tapa de Aluminio inyectado / Injected Aluminum Cover
Meriva	1.4 8V 4 Cil	01/09	12/14	<b>NKBO0300</b>	
	1.8 16V 4 Cil	01/02	12/04	<b>NKBO0331</b>	
	1.8 16V 4 Cil	01/05	12/07	<b>NKBO0333</b>	
	1.8 8V 4 Cil	01/05	12/12	<b>NKBO0335</b>	
Montana	1.4 8V 4 Cil	01/10	12/16	<b>NKBO0300</b>	
	1.8 8V 4 Cil	01/04	12/11	<b>NKBO0335</b>	
Monza	1.6 8V	01/82	12/86	<b>NKBO0315</b>	
	1.8 8V	01/82	12/86	<b>NKBO0315</b>	
	1.8 8V	01/87	12/96	<b>NKBO0310</b>	
	2.0 8V	01/87	12/96	<b>NKBO0310</b>	
	2.0 8V 4 Cil	01/87	12/96	<b>NKBO0340</b>	Rosca de 8 mm para fixação do carter / Thread with 8 mm to fix in the carter
Omega	2.0 4 Cil	01/93	12/94	<b>NKBO0310</b>	
	2.0 8V 4 Cil	01/93	12/98	<b>NKBO0340</b>	Rosca de 8 mm para fixação do carter / Thread with 8 mm to fix in the carter
	2.2 4 Cil	01/93	12/98	<b>NKBO0305</b>	Rosca de 6 mm para fixação do carter / Thread with 6 mm to fix in the carter
	4.1 4 Cil	01/95	12/97	<b>NKBO0325</b>	Corpo em Alumínio Injetado / Cuerpo de Aluminio Inyectado / Injected Aluminum Body





**Veículos de Passeio & Pick-ups / Vehiculos de Paseo y Camionetas / Passenger Cars & Light Pick-ups**

**GENERAL MOTORS**

Opala	2.5	01/68	12/92	<b>NKBO0325</b>	Corpo em Alumínio Injetado / Cuerpo de Aluminio Inyectado / Injected Aluminum Body
	4.1	01/68	12/92	<b>NKBO0325</b>	Corpo em Alumínio Injetado / Cuerpo de Aluminio Inyectado / Injected Aluminum Body
Prisma	1.0 VHC 4 Cil	01/09	12/14	<b>NKBO0300</b>	
	1.4 8V 4 Cil	01/07	12/12	<b>NKBO0300</b>	
S10	2.8 TURBO	01/00	12/12	<b>NKBO0773</b>	
	2.2 EFI 4 Cil	01/96	12/00	<b>NKBO0305</b>	Rosca de 6 mm para fixação do carter / Thread with 6 mm to fix in the carter
	2.4 MPFI 4 Cil	01/01	12/11	<b>NKBO0305</b>	Rosca de 6 mm para fixação do carter / Thread with 6 mm to fix in the carter
	2.4 MPFI 4 Cil	01/01	12/11	<b>NKBO0340</b>	Rosca de 8 mm para fixação do carter / Thread with 8 mm to fix in the carter
	2.5 4 Cil Diesel	01/96	12/00	<b>NKBO0343</b>	
Silverado	SPRINT 4.2 TURBO	01/97	12/01	<b>NKBO0773</b>	
	4.1 4 Cil	01/97	12/02	<b>NKBO0325</b>	Corpo em Alumínio Injetado / Cuerpo de Aluminio Inyectado / Injected Aluminum Body
	S4 Maxion 4 Cil	01/97	12/02	<b>NKBO0400</b>	
Sonic	1.6 16V ECOTEC	01/12	12/14	<b>NKBO0345</b>	
Suprema	2.0 4 Cil	01/93	12/94	<b>NKBO0310</b>	
	2.0 8V 4 Cil	01/93	12/98	<b>NKBO0340</b>	Rosca de 8 mm para fixação do carter / Thread with 8 mm to fix in the carter
	2.2 4 Cil	01/93	12/98	<b>NKBO0305</b>	Rosca de 6 mm para fixação do carter / Thread with 6 mm to fix in the carter
	4.1 4 Cil	01/95	12/96	<b>NKBO0325</b>	Corpo em Alumínio Injetado / Cuerpo de Aluminio Inyectado / Injected Aluminum Body
Tigra	1.6	01/98	12/98	<b>NKBO0300</b>	
Vectra	2.0 16V 4 Cil	01/97	01/98	<b>NKBO0340</b>	Rosca de 8 mm para fixação do carter / Thread with 8 mm to fix in the carter
	2.0 16V 4 Cil	01/97	12/05	<b>NKBO0330</b>	
	2.0 8V 4 Cil	01/94	12/11	<b>NKBO0305</b>	Rosca de 6 mm para fixação do carter / Thread with 6 mm to fix in the carter
	2.0 8V 4 Cil	01/97	12/11	<b>NKBO0340</b>	Rosca de 8 mm para fixação do carter / Thread with 8 mm to fix in the carter
	2.2 16V 4 Cil	01/97	12/05	<b>NKBO0330</b>	
	2.2 16V 4 Cil	01/97	12/98	<b>NKBO0340</b>	Rosca de 8 mm para fixação do carter / Thread with 8 mm to fix in the carter
	2.2 8V 4 Cil	01/97	12/05	<b>NKBO0305</b>	Rosca de 6 mm para fixação do carter / Thread with 6 mm to fix in the carter
	2.2 8V 4 Cil	01/97	12/98	<b>NKBO0340</b>	Rosca de 8 mm para fixação do carter / Thread with 8 mm to fix in the carter
	2.4 16V 4 Cil	01/06	12/12	<b>NKBO0350</b>	
	Veraneio	4.1	01/91	12/94	<b>NKBO0325</b>
Zafira	2.0 16V 4 Cil	01/01	12/07	<b>NKBO0340</b>	Rosca de 8 mm para fixação do carter / Thread with 8 mm to fix in the carter
	2.0 16V 4 Cil	01/01	12/07	<b>NKBO0330</b>	
	2.0 8V 4 Cil	01/01	12/12	<b>NKBO0305</b>	Rosca de 6 mm para fixação do carter / Thread with 6 mm to fix in the carter

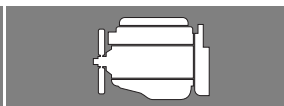

**Veículos de Passeio & Pick-ups / Vehiculos de Paseo y Camionetas / Passenger Cars & Light Pick-ups**

**GENERAL MOTORS**

Zafira	2.0 8V 4 Cil	01/01	12/12	<b>NKBO0340</b>	Rosca de 8 mm para fixação do carter / Thread with 8 mm to fix in the carter
	2.4 16V 4 Cil	01/04	12/12	<b>NKBO0350</b>	

**HONDA**

Fit	1.4 16V 4 Cil	01/04	12/08	<b>NKBO10000</b>	
	1.4 8V 4 Cil	01/04	12/08	<b>NKBO10000</b>	
	1.5 16V 4 Cil	01/04	12/08	<b>NKBO10000</b>	
New Fit	1.4 16V 4 Cil	01/11	06/14	<b>NKBO10001</b>	
	1.5 16V 4 Cil	01/09	06/14	<b>NKBO10001</b>	

**MERCEDES BENZ**

Sprinter	2.5 Diesel	01/97	12/09	<b>NKBO0343</b>	
	OM611 LA 4 Cil Diesel	01/02	12/10	<b>NKBO0525</b>	

**NISSAN**

Frontier	2.8 TURBO	01/02	12/07	<b>NKBO0773</b>	
----------	-----------	-------	-------	-----------------	--

**PEUGEOT**

206	1.4	01/05	12/10	<b>NKBO0804</b>	
	1.6 16V 4 Cil	01/99	12/06	<b>NKBO0801</b>	
	1.6 8V 4 Cil	01/99	12/01	<b>NKBO0803</b>	Engrenagem 29 Dentes / Engranaje 29 dientes / Gear 29 Teeth
207	1.4 8V 4 Cil	01/05	12/14	<b>NKBO0804</b>	
	1.6 16V 4 Cil	01/09	12/14	<b>NKBO0801</b>	
208	1.4 8V 4 Cil	01/13	12/15	<b>NKBO0804</b>	
306	1.8 16V	01/97	12/06	<b>NKBO0802</b>	
307	1.6 16V 4 Cil	01/02	12/06	<b>NKBO0801</b>	
	2.0 16V 4 Cil	01/01	12/12	<b>NKBO0805</b>	
308	1.6 16V 4 Cil	01/12	12/16	<b>NKBO0801</b>	
	2.0 16V 4 Cil	01/12	12/16	<b>NKBO0805</b>	
404	2.0 16V 4 Cil	01/01	12/05	<b>NKBO0805</b>	
406	2.0 16V	01/98	12/06	<b>NKBO0802</b>	
407	2.0 16V 4 Cil	01/05	12/11	<b>NKBO0805</b>	
504	2.3 Diesel	01/68	12/87	<b>NKBO0800</b>	

**RENAULT**

Clio	1.6 16V 4 Cil	01/02	12/11	<b>NKBO0905</b>	Engrenagem 22 dentes / Engranaje 22 dientes / Gear 22 Teeth
	1.6 16V 4 Cil	01/05	12/11	<b>NKBO0909</b>	Engrenagem 22 Dentes / Engranaje 22 dientes / Gear 22 Teeth
	1.6 16V 4 Cil	01/99	12/11	<b>NKBO0903</b>	Engrenagem 24 dentes / Engranaje 24 dientes / Gear 24 Teeth
	1.6 8V 4 Cil	01/99	12/11	<b>NKBO0904</b>	Engrenagem 24 dentes / Engranaje 24 dientes / Gear 24 Teeth
Clio Sedan	1.6 16V 4 Cil	01/02	12/11	<b>NKBO0905</b>	Engrenagem 22 dentes / Engranaje 22 dientes / Gear 22 Teeth
	1.6 16V 4 Cil	01/99	12/11	<b>NKBO0903</b>	Engrenagem 24 dentes / Engranaje 24 dientes / Gear 24 Teeth
Duster	1.6 16V Hi-flex 4 Cil	01/12	12/16	<b>NKBO0909</b>	Engrenagem 22 Dentes / Engranaje 22 dientes / Gear 22 Teeth
Fuego	2.0	01/81	12/85	<b>NKBO0900</b>	
Kangoo	1.6 16V 4 Cil	01/02	06/12	<b>NKBO0909</b>	Engrenagem 22 Dentes / Engranaje 22 dientes / Gear 22 Teeth
	1.6 8V 4 Cil	01/00	12/03	<b>NKBO0904</b>	Engrenagem 24 dentes / Engranaje 24 dientes / Gear 24 Teeth



**Veículos de Passeio & Pick-ups / Vehiculos de Paseo y Camionetas / Passenger Cars & Light Pick-ups**

**RENAULT**

Logan	1.6 16V 4 Cil	01/08	12/13	<b>NKBO0909</b>	Engrenagem 22 Dentes / Engranaje 22 dientes / Gear 22 Teeth
	1.6 8V 4 Cil	01/08	12/13	<b>NKBO0908</b>	Engrenagem 22 Dentes / Engranaje 22 dientes / Gear 22 Teeth
Megane	1.6 16V 4 Cil	01/02	12/05	<b>NKBO0905</b>	Engrenagem 22 dentes / Engranaje 22 dientes / Gear 22 Teeth
	1.6 16V 4 Cil	01/05	12/12	<b>NKBO0909</b>	Engrenagem 22 Dentes / Engranaje 22 dientes / Gear 22 Teeth
	1.6 16V 4 Cil	01/99	12/06	<b>NKBO0903</b>	Engrenagem 24 dentes / Engranaje 24 dientes / Gear 24 Teeth
	1.6 8V 4 Cil	01/98	12/04	<b>NKBO0904</b>	Engrenagem 24 dentes / Engranaje 24 dientes / Gear 24 Teeth
	2.0 8V 4 Cil	01/98	12/01	<b>NKBO0902</b>	Engrenagem 24 dentes / Engranaje 24 dientes / Gear 24 Teeth
R18	2.0	01/82	12/86	<b>NKBO0900</b>	
	2.1 Diesel	01/81	12/86	<b>NKBO0900</b>	
R19	1.8 8V Diesel	01/86	12/94	<b>NKBO0900</b>	
	2.0 8V Diesel	01/86	12/94	<b>NKBO0900</b>	
R21	Todos 4 Cil	01/86	12/94	<b>NKBO0900</b>	
Sandero	1.6 16V 4 Cil	01/08	12/16	<b>NKBO0909</b>	Engrenagem 22 Dentes / Engranaje 22 dientes / Gear 22 Teeth
	1.6 8V 4 Cil	01/08	12/16	<b>NKBO0908</b>	Engrenagem 22 Dentes / Engranaje 22 dientes / Gear 22 Teeth
Scénic	1.6 16V 4 Cil	01/02	12/04	<b>NKBO0905</b>	Engrenagem 22 dentes / Engranaje 22 dientes / Gear 22 Teeth
	1.6 16V 4 Cil	01/05	12/12	<b>NKBO0909</b>	Engrenagem 22 Dentes / Engranaje 22 dientes / Gear 22 Teeth
	2.0 16V 4 Cil	01/02	12/12	<b>NKBO0906</b>	
	2.0 8V 4 Cil	01/99	06/12	<b>NKBO0902</b>	Engrenagem 24 dentes / Engranaje 24 dientes / Gear 24 Teeth
Symbol	1.6 16V Hi-flex 4 Cil	01/09	12/13	<b>NKBO0909</b>	Engrenagem 22 Dentes / Engranaje 22 dientes / Gear 22 Teeth
Traffic	2.2 Diesel	01/94	12/06	<b>NKBO0900</b>	

**SEAT**

Alhambra	2.0	01/96	01/05	<b>NKBO0760*</b>	Com Defletor de Óleo / Con Deflector de Aceite / With Oil Deflector
Cordoba	1.6 8V EA113 4 Cil	01/99	12/07	<b>NKBO0787</b>	
	1.8	01/94	01/05	<b>NKBO0760*</b>	Com Defletor de Óleo / Con Deflector de Aceite / With Oil Deflector
	2.0	03/94	04/98	<b>NKBO0795*</b>	
Ibiza	1.6 8V EA113 4 Cil	01/99	12/07	<b>NKBO0787</b>	
	1.8	01/93	12/98	<b>NKBO0760*</b>	Com Defletor de Óleo / Con Deflector de Aceite / With Oil Deflector
	2.0	06/96	12/05	<b>NKBO0795*</b>	
Inca	1.6 EFI	01/88	12/98	<b>NKBO0730</b>	Engrenagem de 36mm, Com Defletor de Óleo / Engranaje de 36mm Con Deflector de Aceite / 3mm Gear with Oil Deflector
Toledo	2.0	08/92	08/97	<b>NKBO0795*</b>	
Vario	1.6 8V EA113 4 Cil	01/99	12/07	<b>NKBO0787</b>	

**TOYOTA**

Bandeirantes	OM 314 4 Cil Diesel	01/73	12/83	<b>NKBO0500</b>	Engrenagens de 40 mm Sem Contagiado / Engranajes de 40 mm Sin Contragiado / Without Counter-rotation
Corolla	1.6 16V 4 Cil	01/02	12/08	<b>NKBO11000</b>	
	1.8 16V 4 Cil	01/02	12/08	<b>NKBO11000</b>	
Fielder	1.6 16V 4 Cil	01/02	12/08	<b>NKBO11000</b>	
	1.8 16V 4 Cil	01/02	12/08	<b>NKBO11000</b>	

**VOLKSWAGEN**

Apollo	1.8 AP 8V	01/90	12/92	<b>NKBO0730</b>	Engrenagem de 36mm, Com Defletor de Óleo / Engranaje de 36mm Con Deflector de Aceite / 3mm Gear with Oil Deflector
--------	-----------	-------	-------	-----------------	---

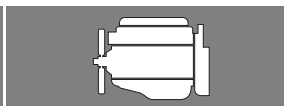

**Veículos de Passeio & Pick-ups / Vehículos de Paseo y Camionetas / Passenger Cars & Light Pick-ups**

**VOLKSWAGEN**

Apollo	1.8 AP 8V	01/90	12/92	<b>NKBO0745</b>	Sem Defletor de Óleo / Sin Deflector de Aceite / Without Oil Deflector
	2.0 AP 8V	01/90	12/92	<b>NKBO0745</b>	Sem Defletor de Óleo / Sin Deflector de Aceite / Without Oil Deflector
	2.0 AP 8V	01/90	12/92	<b>NKBO0730</b>	Engrenagem de 36mm, Com Defletor de Óleo / Engranaje de 36mm Con Deflector de Aceite / 3mm Gear with Oil Deflector
Bora	2.0 8V 4 Cil	01/00	12/11	<b>NKBO0787</b>	
Brasília	1.5	01/73	12/82	<b>NKBO0705</b>	Engrenagem de 21mm, Flange de 8mm e Furos de 8mm sem tampa / Engranaje de 21 mm, Flange de 8mm y huecos de 8mm sin tapa / 21mm Gear, 8mm Flange with 8mm Holes without cover
	1.5	01/73	12/82	<b>NKBO0710</b>	Engrenagem de 26mm, Flange de 12mm e Furos de 8mm sem tampa / Engranaje de 26 mm, Flange de 12mm y huecos de 8mm sin tapa / 26mm Gear, 12mm Flange with 8mm Holes without cover
	1.6	01/73	12/82	<b>NKBO0710</b>	Engrenagem de 26mm, Flange de 12mm e Furos de 8mm sem tampa / Engranaje de 26 mm, Flange de 12mm y huecos de 8mm sin tapa / 26mm Gear, 12mm Flange with 8mm Holes without cover
	1.6	01/73	12/82	<b>NKBO0705</b>	Engrenagem de 21mm, Flange de 8mm e Furos de 8mm sem tampa / Engranaje de 21 mm, Flange de 8mm y huecos de 8mm sin tapa / 21mm Gear, 8mm Flange with 8mm Holes without cover
Caddy	1.6 EFI	01/88	12/98	<b>NKBO0730</b>	Engrenagem de 36mm, Com Defletor de Óleo / Engranaje de 36mm Con Deflector de Aceite / 3mm Gear with Oil Deflector
Crossfox	1.0 8V AT 4 Cil	01/05	12/14	<b>NKBO0700</b>	
	1.6 8V AT 4 Cil	01/05	12/14	<b>NKBO0700</b>	
Fox	1.0 8V AT 4 Cil	01/04	12/14	<b>NKBO0700</b>	
	1.6 8V AT 4 Cil	01/04	12/14	<b>NKBO0700</b>	
Fusca	1.3	01/67	12/96	<b>NKBO0705</b>	Engrenagem de 21mm, Flange de 8mm e Furos de 8mm sem tampa / Engranaje de 21 mm, Flange de 8mm y huecos de 8mm sin tapa / 21mm Gear, 8mm Flange with 8mm Holes without cover
	1.3	01/67	12/96	<b>NKBO0710</b>	Engrenagem de 26mm, Flange de 12mm e Furos de 8mm sem tampa / Engranaje de 26 mm, Flange de 12mm y huecos de 8mm sin tapa / 26mm Gear, 12mm Flange with 8mm Holes without cover
	1.5	01/67	12/96	<b>NKBO0705</b>	Engrenagem de 21mm, Flange de 8mm e Furos de 8mm sem tampa / Engranaje de 21 mm, Flange de 8mm y huecos de 8mm sin tapa / 21mm Gear, 8mm Flange with 8mm Holes without cover
	1.5	01/67	12/96	<b>NKBO0710</b>	Engrenagem de 26mm, Flange de 12mm e Furos de 8mm sem tampa / Engranaje de 26 mm, Flange de 12mm y huecos de 8mm sin tapa / 26mm Gear, 12mm Flange with 8mm Holes without cover
	1.6	01/67	12/96	<b>NKBO0710</b>	Engrenagem de 26mm, Flange de 12mm e Furos de 8mm sem tampa / Engranaje de 26 mm, Flange de 12mm y huecos de 8mm sin tapa / 26mm Gear, 12mm Flange with 8mm Holes without cover
	1.6	01/67	12/96	<b>NKBO0705</b>	Engrenagem de 21mm, Flange de 8mm e Furos de 8mm sem tampa / Engranaje de 21 mm, Flange de 8mm y huecos de 8mm sin tapa / 21mm Gear, 8mm Flange with 8mm Holes without cover
Gol	1.0 16V 4 Cil	01/97	12/98	<b>NKBO0704</b>	Corrente não inclusa / Cadena no incluida / Chain not included
	1.0 16V Power 4 Cil	01/98	12/08	<b>NKBO0700</b>	
	1.0 8V 4 Cil	11/96	12/98	<b>NKBO0704</b>	Corrente não inclusa / Cadena no incluida / Chain not included
	1.0 8V AT 4 Cil	10/08	12/16	<b>NKBO0700</b>	
	1.0 8V Power 4 Cil	01/98	12/14	<b>NKBO0700</b>	
	1.0 AE 4 Cil	01/93	12/96	<b>NKBO0735</b>	
	1.3 Ar 4 Cil	01/80	12/83	<b>NKBO0710</b>	Engrenagem de 26mm, Flange de 12mm e Furos de 8mm sem tampa / Engranaje de 26 mm, Flange de 12mm y huecos de 8mm sin tapa / 26mm Gear, 12mm Flange with 8mm Holes without cover
1.3 Ar 4 Cil	01/80	12/83	<b>NKBO0705</b>	Engrenagem de 21mm, Flange de 8mm e Furos de 8mm sem tampa / Engranaje de 21 mm, Flange de 8mm y huecos de 8mm sin tapa / 21mm Gear, 8mm Flange with 8mm Holes without cover	



**Veículos de Passeio & Pick-ups / Vehículos de Paseo y Camionetas / Passenger Cars & Light Pick-ups**

**VOLKSWAGEN**

Gol	1.6 4 Cil	01/81	12/83	<b>NKBO0715</b>	
	1.6 4 Cil	01/85	12/89	<b>NKBO0720</b>	Engrenagem de 30mm / Engranaje de 30mm / 30mm Gear
	1.6 8V 4 Cil	01/03	12/08	<b>NKBO0776</b>	
	1.6 8V AT 4 Cil	10/08	12/16	<b>NKBO0700</b>	
	1.6 AE 4 Cil	01/90	12/94	<b>NKBO0735</b>	
	1.6 AP 8V 4 Cil	01/85	12/89	<b>NKBO0720</b>	Engrenagem de 30mm / Engranaje de 30mm / 30mm Gear
	1.6 AP 8V 4 Cil	01/88	12/02	<b>NKBO0725</b>	Engrenagem de 36mm / Engranaje de 36mm / 36mm Gear
	1.6 Ar 4 Cil	01/80	12/83	<b>NKBO0705</b>	Engrenagem de 21mm, Flange de 8mm e Furos de 8mm sem tampa / Engranaje de 21 mm, Flange de 8mm y huecos de 8mm sin tapa / 21mm Gear, 8mm Flange with 8mm Holes without cover
	1.6 Ar 4 Cil	01/80	12/83	<b>NKBO0710</b>	Engrenagem de 26mm, Flange de 12mm e Furos de 8mm sem tampa / Engranaje de 26 mm, Flange de 12mm y huecos de 8mm sin tapa / 26mm Gear, 12mm Flange with 8mm Holes without cover
	1.8 8V 4 Cil	01/03	12/08	<b>NKBO0776</b>	
	1.8 AP 8V 4 Cil	01/85	12/89	<b>NKBO0720</b>	Engrenagem de 30mm / Engranaje de 30mm / 30mm Gear
	1.8 AP 8V 4 Cil	01/88	12/02	<b>NKBO0725</b>	Engrenagem de 36mm / Engranaje de 36mm / 36mm Gear
	2.0 16V 4 Cil	01/96	12/02	<b>NKBO0740</b>	
	2.0 AP 8V 4 Cil	01/88	12/02	<b>NKBO0725</b>	Engrenagem de 36mm / Engranaje de 36mm / 36mm Gear
	Golf	1.5 4 Cil Diesel	01/82	12/84	<b>NKBO0796*</b>
1.6 8V (EA111) 4 Cil		07/99	12/14	<b>NKBO0700</b>	
1.6 8V (EA113) 4 Cil		08/99	06/01	<b>NKBO0787</b>	
1.6 8V 4 Cil		01/84	12/84	<b>NKBO0794*</b>	Com Defletor de Óleo / Con Deflector de Aceite / With Oil Deflector
1.8 8V 4 Cil		01/82	12/84	<b>NKBO0796*</b>	Com Defletor de Óleo / Con Deflector de Aceite / With Oil Deflector
1.8 8V 4 Cil		01/84	12/84	<b>NKBO0794*</b>	Com Defletor de Óleo / Con Deflector de Aceite / With Oil Deflector
1.8 8V 4 Cil		01/86	12/91	<b>NKBO0798*</b>	Com Defletor de Óleo / Con Deflector de Aceite / With Oil Deflector
1.8 8V 4 Cil		01/92	12/98	<b>NKBO0760*</b>	Com Defletor de Óleo / Con Deflector de Aceite / With Oil Deflector
1.8T 150cv 4 Cil		08/99	06/01	<b>NKBO0787</b>	
2.0 16V 4 Cil		08/92	08/97	<b>NKBO0795*</b>	
Jetta	2.0 8V 4 Cil	01/92	12/98	<b>NKBO0760*</b>	Com Defletor de Óleo / Con Deflector de Aceite / With Oil Deflector
	2.0 8V 4 Cil	08/99	06/01	<b>NKBO0787</b>	
	1.5	01/82	12/84	<b>NKBO0796*</b>	Com Defletor de Óleo / Con Deflector de Aceite / With Oil Deflector
	1.6	01/80	12/80	<b>NKBO0793*</b>	
	1.6	01/84	12/84	<b>NKBO0794*</b>	Com Defletor de Óleo / Con Deflector de Aceite / With Oil Deflector
	1.7	01/81	12/84	<b>NKBO0793*</b>	
	1.8	01/82	12/84	<b>NKBO0796*</b>	Com Defletor de Óleo / Con Deflector de Aceite / With Oil Deflector
1.8	01/84	12/84	<b>NKBO0794*</b>	Com Defletor de Óleo / Con Deflector de Aceite / With Oil Deflector	
1.8 16V	01/85	12/92	<b>NKBO0798*</b>	Com Defletor de Óleo / Con Deflector de Aceite / With Oil Deflector	
Kombi	1.4 8V AT 4 Cil	01/06	12/14	<b>NKBO0700</b>	
	1.5	01/57	12/06	<b>NKBO0710</b>	Engrenagem de 26mm, Flange de 12mm e Furos de 8mm sem tampa / Engranaje de 26 mm, Flange de 12mm y huecos de 8mm sin tapa / 26mm Gear, 12mm Flange with 8mm Holes without cover
	1.5	01/57	12/56	<b>NKBO0705</b>	Engrenagem de 21mm, Flange de 8mm e Furos de 8mm sem tampa / Engranaje de 21 mm, Flange de 8mm y huecos de 8mm sin tapa / 21mm Gear, 8mm Flange with 8mm Holes without cover
	1.6	01/57	12/96	<b>NKBO0705</b>	Engrenagem de 21mm, Flange de 8mm e Furos de 8mm sem tampa / Engranaje de 21 mm, Flange de 8mm y huecos de 8mm sin tapa / 21mm Gear, 8mm Flange with 8mm Holes without cover

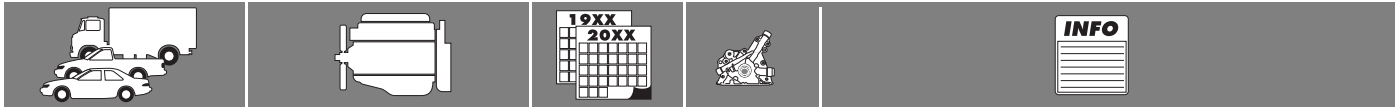

**Veículos de Passeio & Pick-ups / Vehiculos de Paseo y Camionetas / Passenger Cars & Light Pick-ups**

**VOLKSWAGEN**

Kombi	1.6	01/57	12/96	<b>NKBO0710</b>	Engrenagem de 26mm, Flange de 12mm e Furos de 8mm sem tampa / Engranaje de 26 mm, Flange de 12mm y huecos de 8mm sin tapa / 26mm Gear, 12mm Flange with 8mm Holes without cover
	1.6 Diesel	01/81	12/82	<b>NKBO0785*</b>	
	1200	01/57	12/96	<b>NKBO0705</b>	Engrenagem de 21mm, Flange de 8mm e Furos de 8mm sem tampa / Engranaje de 21 mm, Flange de 8mm y huecos de 8mm sin tapa / 21mm Gear, 8mm Flange with 8mm Holes without cover
Logus	1200	01/57	12/96	<b>NKBO0710</b>	Engrenagem de 26mm, Flange de 12mm e Furos de 8mm sem tampa / Engranaje de 26 mm, Flange de 12mm y huecos de 8mm sin tapa / 26mm Gear, 12mm Flange with 8mm Holes without cover
	1.8 AP 8V	01/93	12/97	<b>NKBO0745</b>	Sem Defletor de Óleo / Sin Deflector de Aceite / Without Oil Deflector
	1.8 AP 8V	01/93	12/97	<b>NKBO0730</b>	Engrenagem de 36mm, Com Defletor de Óleo / Engranaje de 36mm Con Deflector de Aceite / 3mm Gear with Oil Deflector
	2.0 AP 8V	01/93	12/97	<b>NKBO0730</b>	Engrenagem de 36mm, Com Defletor de Óleo / Engranaje de 36mm Con Deflector de Aceite / 3mm Gear with Oil Deflector
New Beetle	2.0 AP 8V	01/93	12/97	<b>NKBO0745</b>	Sem Defletor de Óleo / Sin Deflector de Aceite / Without Oil Deflector
	2.0 8V 4 Cil	01/99	12/11	<b>NKBO0787</b>	
Parati	1.0 16V 4 Cil	01/97	12/98	<b>NKBO0704</b>	Corrente não inclusa / Cadena no incluida / Chain not included
	1.0 16V Power 4 Cil	01/98	12/09	<b>NKBO0700</b>	
	1.0 8V Power 4 Cil	01/98	12/09	<b>NKBO0700</b>	
	1.6 4 Cil	01/82	12/83	<b>NKBO0715</b>	
	1.6 8V 4 Cil	01/03	12/08	<b>NKBO0776</b>	
	1.6 AE 4 Cil	01/90	12/95	<b>NKBO0735</b>	
	1.6 AP 8V 4 Cil	01/84	12/89	<b>NKBO0720</b>	Engrenagem de 30mm / Engranaje de 30mm / 30mm Gear
	1.6 AP 8V 4 Cil	01/88	12/02	<b>NKBO0725</b>	Engrenagem de 36mm / Engranaje de 36mm / 36mm Gear
	1.8 4 Cil	01/84	12/89	<b>NKBO0720</b>	Engrenagem de 30mm / Engranaje de 30mm / 30mm Gear
	1.8 8V 4 Cil	01/03	12/08	<b>NKBO0776</b>	
	1.8 AP 8V 4 Cil	01/84	12/89	<b>NKBO0720</b>	Engrenagem de 30mm / Engranaje de 30mm / 30mm Gear
	1.8 AP 8V 4 Cil	01/88	12/02	<b>NKBO0725</b>	Engrenagem de 36mm / Engranaje de 36mm / 36mm Gear
	2.0 16V 4 Cil	01/97	12/02	<b>NKBO0740</b>	
	2.0 AP 8V 4 Cil	01/88	12/02	<b>NKBO0725</b>	Engrenagem de 36mm / Engranaje de 36mm / 36mm Gear
Passat	1.5 4 Cil	01/74	12/83	<b>NKBO0715</b>	
	1.5 4 Cil Diesel	01/78	12/88	<b>NKBO0785*</b>	
	1.6 4 Cil	01/74	12/83	<b>NKBO0715</b>	
	1.6 4 Cil	01/84	12/89	<b>NKBO0720</b>	Engrenagem de 30mm / Engranaje de 30mm / 30mm Gear
	1.6 4 Cil Diesel	01/78	12/88	<b>NKBO0785*</b>	
	1.6 AP 8V 4 Cil	01/84	12/89	<b>NKBO0720</b>	Engrenagem de 30mm / Engranaje de 30mm / 30mm Gear
	1.6 Turbo 4 Cil Diesel	01/81	12/88	<b>NKBO0785*</b>	
	1.8 20V Turbo 4 Cil	11/96	12/06	<b>NKBO0797</b>	
	1.8 4 Cil	01/84	12/89	<b>NKBO0720</b>	Engrenagem de 30mm / Engranaje de 30mm / 30mm Gear
	1.8 AP 8V 4 Cil	01/84	12/89	<b>NKBO0720</b>	Engrenagem de 30mm / Engranaje de 30mm / 30mm Gear
	1.8T 150cv 4 Cil	03/01	09/05	<b>NKBO0787</b>	
	2.0 16V 4 Cil	08/88	09/93	<b>NKBO0795*</b>	
	2.0 4 Cil	01/90	12/97	<b>NKBO0760*</b>	Com Defletor de Óleo / Con Deflector de Aceite / With Oil Deflector
2.0 4 Cil	01/95	12/97	<b>NKBO0795*</b>		
2.0 FSI 4 Cil	01/07	12/09	<b>NKBO0776</b>		



**Veículos de Passeio & Pick-ups / Vehiculos de Paseo y Camionetas / Passenger Cars & Light Pick-ups**

**VOLKSWAGEN**

Pointer	1.8 AP 8V	01/94	12/96	<b>NKBO0730</b>	Engrenagem de 36mm, Com Defletor de Óleo / Engranaje de 36mm Con Deflector de Aceite / 3mm Gear with Oil Deflector
	1.8 AP 8V	01/94	12/96	<b>NKBO0745</b>	Sem Defletor de Óleo / Sin Deflector de Aceite / Without Oil Deflector
	2.0 AP 8V	01/94	12/96	<b>NKBO0745</b>	Sem Defletor de Óleo / Sin Deflector de Aceite / Without Oil Deflector
	2.0 AP 8V	01/94	12/96	<b>NKBO0730</b>	Engrenagem de 36mm, Com Defletor de Óleo / Engranaje de 36mm Con Deflector de Aceite / 3mm Gear with Oil Deflector
Polo	1.6 8V AT 4 Cil	01/02	12/16	<b>NKBO0700</b>	
	2.0 8V 4 Cil	01/03	12/14	<b>NKBO0787</b>	
Polo Classic	1.0 16V AT 4 Cil	01/00	12/03	<b>NKBO0700</b>	
	1.8 AP 8V 4 Cil	01/97	12/01	<b>NKBO0745</b>	Sem Defletor de Óleo / Sin Deflector de Aceite / Without Oil Deflector
	1.8 AP 8V 4 Cil	01/97	12/01	<b>NKBO0730</b>	Engrenagem de 36mm, Com Defletor de Óleo / Engranaje de 36mm Con Deflector de Aceite / 3mm Gear with Oil Deflector
Polo Sedan	1.6 8V AT 4 Cil	01/02	12/14	<b>NKBO0700</b>	
	2.0 8V 4 Cil	01/03	12/14	<b>NKBO0787</b>	
	2.0 AP 8V 4 Cil	01/97	12/01	<b>NKBO0745</b>	Sem Defletor de Óleo / Sin Deflector de Aceite / Without Oil Deflector
Quantum	1.8	01/86	12/89	<b>NKBO0720</b>	Engrenagem de 30mm / Engranaje de 30mm / 30mm Gear
	1.8 AP 8V	01/88	12/02	<b>NKBO0725</b>	Engrenagem de 36mm / Engranaje de 36mm / 36mm Gear
	2.0 AP 8V	01/88	12/02	<b>NKBO0725</b>	Engrenagem de 36mm / Engranaje de 36mm / 36mm Gear
Rabbit	1.5	01/74	12/80	<b>NKBO0793*</b>	
	1.6	01/76	12/80	<b>NKBO0793*</b>	
	1.7	01/81	12/84	<b>NKBO0793*</b>	
Santana	1.5 Diesel	01/84	12/88	<b>NKBO0785*</b>	
	1.6 Diesel	01/81	12/88	<b>NKBO0785*</b>	
	1.6 Turbo Diesel	01/81	12/88	<b>NKBO0785*</b>	
	1.8	01/85	12/89	<b>NKBO0720</b>	Engrenagem de 30mm / Engranaje de 30mm / 30mm Gear
	1.8 AP 8V	01/85	12/89	<b>NKBO0720</b>	Engrenagem de 30mm / Engranaje de 30mm / 30mm Gear
	1.8 AP 8V	01/88	12/02	<b>NKBO0725</b>	Engrenagem de 36mm / Engranaje de 36mm / 36mm Gear
	2.0 AP 8V	01/88	12/02	<b>NKBO0725</b>	Engrenagem de 36mm / Engranaje de 36mm / 36mm Gear
Saveiro	1.6	01/84	12/89	<b>NKBO0720</b>	Engrenagem de 30mm / Engranaje de 30mm / 30mm Gear
	1.6 8V 4 Cil	01/03	12/09	<b>NKBO0776</b>	
	1.6 8V AT 4 Cil	01/10	06/12	<b>NKBO0700</b>	
	1.6 AE	01/90	12/96	<b>NKBO0735</b>	
	1.6 AP 8V	01/84	12/89	<b>NKBO0720</b>	Engrenagem de 30mm / Engranaje de 30mm / 30mm Gear
	1.6 AP 8V	01/88	12/02	<b>NKBO0725</b>	Engrenagem de 36mm / Engranaje de 36mm / 36mm Gear
	1.8 8V 4 Cil	01/03	12/09	<b>NKBO0776</b>	
	1.8 AP 8V	01/84	12/89	<b>NKBO0720</b>	Engrenagem de 30mm / Engranaje de 30mm / 30mm Gear
	1.8 AP 8V	01/88	12/02	<b>NKBO0725</b>	Engrenagem de 36mm / Engranaje de 36mm / 36mm Gear
	2.0 AP 8V	01/88	12/02	<b>NKBO0725</b>	Engrenagem de 36mm / Engranaje de 36mm / 36mm Gear
Scirocco	1.5 4 Cil	01/75	12/79	<b>NKBO0793*</b>	
	1.5 4 Cil	01/82	12/84	<b>NKBO0796*</b>	Com Defletor de Óleo / Con Deflector de Aceite / With Oil Deflector
	1.6 4 Cil	01/76	12/89	<b>NKBO0793*</b>	
	1.6 4 Cil	01/84	12/84	<b>NKBO0794*</b>	Com Defletor de Óleo / Con Deflector de Aceite / With Oil Deflector
	1.7 4 Cil	01/81	12/83	<b>NKBO0793*</b>	
	1.8 16V 4 Cil	01/85	12/92	<b>NKBO0798*</b>	Com Defletor de Óleo / Con Deflector de Aceite / With Oil Deflector

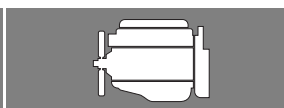

**Veículos de Passeio & Pick-ups / Vehiculos de Paseo y Camionetas / Passenger Cars & Light Pick-ups**

**VOLKSWAGEN**

Scirocco	1.8 4 Cil	01/82	12/84	<b>NKBO0796*</b>	Com Defletor de Óleo / Con Deflector de Aceite / With Oil Deflector
	1.8 4 Cil	01/84	12/84	<b>NKBO0794*</b>	Com Defletor de Óleo / Con Deflector de Aceite / With Oil Deflector
Spacefox	1.6 8V AT 4 Cil	01/05	12/14	<b>NKBO0700</b>	
Transporter	1.3 Diesel	01/69	12/71	<b>NKBO0765*</b>	Engrenagem de 26mm, Flange de 8mm e Furos de 8mm sem tampa / Engranaje de 26 mm, Flange de 8mm y huecos de 8mm sin tapa / 26mm Gear, 8mm Flange with 8mm Holes without cover
	1.3 Diesel	01/69	12/71	<b>NKBO0775*</b>	Engrenagem de 30mm, Flange de 12mm e Furos de 8mm sem tampa / Engranaje de 30 mm, Flange de 12mm y huecos de 8mm sin tapa / 30mm Gear, 12mm Flange with 8mm Holes without cover
	1.3 Diesel	01/71	12/79	<b>NKBO0770*</b>	Engrenagem de 30mm, Flange de 8mm e Furos de 8mm sem tampa / Engranaje de 30 mm, Flange de 8mm y huecos de 8mm sin tapa / 30mm Gear, 8mm Flange with 8mm Holes without cover
	1.5 Diesel	01/69	12/86	<b>NKBO0790*</b>	Engrenagem de 21mm, Flange de 4mm e Furos de 8mm / Engranaje de 21 mm, Flange de 4mm y huecos de 8mm / 21mm Gear, 4mm Flange with 8mm Holes
	1.5 Diesel	01/71	12/92	<b>NKBO0792*</b>	Engrenagem de 26mm, Flange de 4mm e Furos de 8mm / Engranaje de 26 mm, Flange de 4mm y huecos de 8mm / 26mm Gear, 4mm Flange with 8mm Holes
	1.6 Diesel	01/69	12/86	<b>NKBO0790*</b>	Engrenagem de 21mm, Flange de 4mm e Furos de 8mm / Engranaje de 21 mm, Flange de 4mm y huecos de 8mm / 21mm Gear, 4mm Flange with 8mm Holes
	1.6 Diesel	01/69	12/71	<b>NKBO0775*</b>	Engrenagem de 30mm, Flange de 12mm e Furos de 8mm sem tampa / Engranaje de 30 mm, Flange de 12mm y huecos de 8mm sin tapa / 30mm Gear, 12mm Flange with 8mm Holes without cover
	1.6 Diesel	01/69	12/71	<b>NKBO0765*</b>	Engrenagem de 26mm, Flange de 8mm e Furos de 8mm sem tampa / Engranaje de 26 mm, Flange de 8mm y huecos de 8mm sin tapa / 26mm Gear, 8mm Flange with 8mm Holes without cover
	1.6 Diesel	01/71	12/92	<b>NKBO0792*</b>	Engrenagem de 26mm, Flange de 4mm e Furos de 8mm / Engranaje de 26 mm, Flange de 4mm y huecos de 8mm / 26mm Gear, 4mm Flange with 8mm Holes
	1.6 Diesel	01/71	12/79	<b>NKBO0770*</b>	Engrenagem de 30mm, Flange de 8mm e Furos de 8mm sem tampa / Engranaje de 30 mm, Flange de 8mm y huecos de 8mm sin tapa / 30mm Gear, 8mm Flange with 8mm Holes without cover
Van	1.6L EFI	01/97	12/98	<b>NKBO0730</b>	Engrenagem de 36mm, Com Defletor de Óleo / Engranaje de 36mm Con Deflector de Aceite / 3mm Gear with Oil Deflector
Variant	1.6 Diesel	01/81	12/88	<b>NKBO0785*</b>	
	1.6 Turbo Diesel	01/81	12/88	<b>NKBO0785*</b>	
	1.8 20V	11/96	12/06	<b>NKBO0797</b>	
	1.8 20V Turbo	11/96	12/06	<b>NKBO0797</b>	
	1.8T 150cv 4 Cil	03/01	09/05	<b>NKBO0787</b>	
	2.0	01/90	12/97	<b>NKBO0760*</b>	Com Defletor de Óleo / Con Deflector de Aceite / With Oil Deflector
Vento	2.0	01/91	12/97	<b>NKBO0760*</b>	Com Defletor de Óleo / Con Deflector de Aceite / With Oil Deflector
	2.0	06/96	12/05	<b>NKBO0795*</b>	
Voyage	1.0 8V AT 4 Cil	01/09	06/12	<b>NKBO0700</b>	
	1.5	01/82	12/83	<b>NKBO0715</b>	
	1.6	01/82	12/83	<b>NKBO0715</b>	
	1.6 8V AT 4 Cil	01/09	12/16	<b>NKBO0700</b>	
	1.6 AE	01/90	12/94	<b>NKBO0735</b>	
	1.6 AP 8V	01/84	12/89	<b>NKBO0720</b>	Engrenagem de 30mm / Engranaje de 30mm / 30mm Gear
	1.6 AP 8V	01/88	12/94	<b>NKBO0725</b>	Engrenagem de 36mm / Engranaje de 36mm / 36mm Gear
	1.8 AP 8V	01/84	12/89	<b>NKBO0720</b>	Engrenagem de 30mm / Engranaje de 30mm / 30mm Gear





**Veículos de Passeio & Pick-ups / Vehiculos de Paseo y Camionetas / Passenger Cars & Light Pick-ups**

**VOLKSWAGEN**

Voyage	1.8 AP 8V	01/88	12/94	<b>NKBO0725</b>	Engrenagem de 36mm / Engranaje de 36mm / 36mm Gear
	2.0 AP 8V	01/88	12/94	<b>NKBO0725</b>	Engrenagem de 36mm / Engranaje de 36mm / 36mm Gear

**Motor / Motor / Engine**

**M.W.M.**

MWM	D225 3/4/6 Cil Diesel	01/50	12/06	<b>NKBO0600</b>	
	D226 4 Cil Diesel	01/50	12/06	<b>NKBO0600</b>	
	D229 3/4/6 Cil Diesel	01/50	12/06	<b>NKBO0600</b>	

**MERCEDES BENZ**

MERCEDES BENZ	OM 314 6 Cil Diesel	01/80	12/90	<b>NKBO0500</b>	Engrenagens de 40 mm Sem Contagiado / Engranajes de 40mm Sin Contragiado / 40mm Gears, Without Counter-rotation
	OM 352 6 Cil Diesel	01/80	12/90	<b>NKBO0500</b>	Engrenagens de 40 mm Sem Contagiado / Engranajes de 40mm Sin Contragiado / 40mm Gears, Without Counter-rotation
	OM 352A 6 Cil Diesel	01/80	12/90	<b>NKBO0500</b>	Engrenagens de 40 mm Sem Contagiado / Engranajes de 40mm Sin Contragiado / 40mm Gears, Without Counter-rotation
	OM 362 6 Cil Diesel	01/80	12/90	<b>NKBO0500</b>	Engrenagens de 40 mm Sem Contagiado / Engranajes de 40mm Sin Contragiado / 40mm Gears, Without Counter-rotation
	OM 364 4 Cil Diesel	01/80	12/90	<b>NKBO0505</b>	Engrenagens de 40 mm / Engranajes de 40mm / 40mm Gears
	OM 364 6 Cil Diesel	01/80	12/90	<b>NKBO0505</b>	Engrenagens de 40 mm / Engranajes de 40mm / 40mm Gears
	OM 364A 4 Cil Diesel	01/80	12/90	<b>NKBO0505</b>	Engrenagens de 40 mm / Engranajes de 40mm / 40mm Gears
	OM 364A 6 Cil Diesel	01/80	12/90	<b>NKBO0505</b>	Engrenagens de 40 mm / Engranajes de 40mm / 40mm Gears
	OM 366 4 Cil Diesel	01/80	12/90	<b>NKBO0505</b>	Engrenagens de 40 mm / Engranajes de 40mm / 40mm Gears
	OM 366 6 Cil Diesel	01/80	12/90	<b>NKBO0505</b>	Engrenagens de 40 mm / Engranajes de 40mm / 40mm Gears
	OM 366A 6 Cil Diesel	01/80	12/90	<b>NKBO0510</b>	Engrenagens de 50 mm / Engranajes de 50mm / 50mm Gears
	OM 366LA 6 Cil Diesel	01/80	12/90	<b>NKBO0510</b>	Engrenagens de 50 mm / Engranajes de 50mm / 50mm Gears
	OM 447A 5 Cil Diesel	01/80	12/90	<b>NKBO0520</b>	Engrenagens de 34 mm / Engranajes de 34mm / 34mm Gears
	OM 447A 6 Cil Diesel	01/80	12/90	<b>NKBO0520</b>	Engrenagens de 34 mm / Engranajes de 34mm / 34mm Gears
	OM 447LA 5 Cil Diesel	01/80	12/90	<b>NKBO0520</b>	Engrenagens de 34 mm / Engranajes de 34mm / 34mm Gears
	OM 447LA 6 Cil Diesel	01/80	12/90	<b>NKBO0520</b>	Engrenagens de 34 mm / Engranajes de 34mm / 34mm Gears
	OM 449A 5 Cil Diesel	01/80	12/90	<b>NKBO0520</b>	Engrenagens de 34 mm / Engranajes de 34mm / 34mm Gears
	OM 449A 6 Cil Diesel	01/80	12/90	<b>NKBO0520</b>	Engrenagens de 34 mm / Engranajes de 34mm / 34mm Gears
	OM 449LA 5 Cil Diesel	01/80	12/90	<b>NKBO0520</b>	Engrenagens de 34 mm / Engranajes de 34mm / 34mm Gears
	OM 449LA 6 Cil Diesel	01/80	12/90	<b>NKBO0520</b>	Engrenagens de 34 mm / Engranajes de 34mm / 34mm Gears

**PERKINS**

Perkins	4203 4 Cil Diesel	01/80	12/90	<b>NKBO0405</b>	
	4236 4 Cil Diesel	01/80	12/90	<b>NKBO0400</b>	
	4248 4 Cil Diesel	01/80	12/90	<b>NKBO0400</b>	
	D4203 4 Cil Diesel	01/80	12/90	<b>NKBO0405</b>	
	Q20B4236 4 Cil Diesel	01/80	12/90	<b>NKBO0400</b>	

**SCANIA**

Diferencial	8 Cil Diesel	01/00	12/14	<b>NKBO0435</b>	Bomba de Óleo do Câmbio
	8 Cil Diesel	01/70	12/09	<b>NKBO0425</b>	Haste 27,7mm

**Máquinas Agrícolas & Fora de Estrada / Vehiculos Fuera de Carretera / Off Highway**

**AGCO**

FG70 Trator	OM 352 6 Cil Diesel	01/80	12/90	<b>NKBO0500</b>	Engrenagens de 40 mm Sem Contagiado / Engranajes de 40 mm Sin Contragiado / Without Counter-rotation
-------------	---------------------	-------	-------	-----------------	--

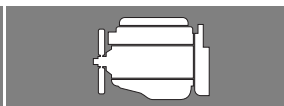

**Máquinas Agrícolas & Fora de Estrada / Vehiculos Fuera de Carretera / Off Highway**

**AGCO**

FG70 Trator	OM 352A 6 Cil Diesel	01/80	12/90	<b>NKBO0500</b>	Engrenagens de 40 mm Sem Contagiro / Engrenajes de 40 mm Sin Contragiro / Without Counter-rotation
FG75 Trator	OM 352 6 Cil Diesel	01/80	12/90	<b>NKBO0500</b>	Engrenagens de 40 mm Sem Contagiro / Engrenajes de 40 mm Sin Contragiro / Without Counter-rotation
	OM 352A 6 Cil Diesel	01/80	12/90	<b>NKBO0500</b>	Engrenagens de 40 mm Sem Contagiro / Engrenajes de 40 mm Sin Contragiro / Without Counter-rotation
Trator	OM 352 6 Cil Diesel	01/80	12/90	<b>NKBO0500</b>	Engrenagens de 40 mm Sem Contagiro / Engrenajes de 40 mm Sin Contragiro / Without Counter-rotation

**CBT**

Trator 1000	Perkins 4203 Diesel	01/76	12/79	<b>NKBO0405</b>	
Trator 1065	OM 314 4 Cil Diesel	01/72	12/82	<b>NKBO0500</b>	Engrenagens de 40 mm Sem Contagiro / Engrenajes de 40 mm Sin Contragiro / Without Counter-rotation
Trator 1105	OM 352 6 Cil Diesel	01/73	12/83	<b>NKBO0500</b>	Engrenagens de 40 mm Sem Contagiro / Engrenajes de 40 mm Sin Contragiro / Without Counter-rotation
Trator 2070	Perkins 4203 Diesel	01/76	12/79	<b>NKBO0405</b>	
Trator 8240	Perkins 4236 4 Cil Diesel	01/85	12/95	<b>NKBO0400</b>	
	Perkins 4248 4 Cil Diesel	01/85	12/95	<b>NKBO0400</b>	
Trator 8440	MWM D229 4 Cil Diesel	01/85	12/95	<b>NKBO0600</b>	

**ENGESA**

EE-510	MWM D229 6 Cil Diesel	01/76	12/86	<b>NKBO0600</b>	
--------	-----------------------	-------	-------	-----------------	--

**FIAT ALLIS**

Trator Rodoviário	OM 352 6 Cil Diesel	01/80	12/90	<b>NKBO0500</b>	Engrenagens de 40 mm Sem Contagiro / Engrenajes de 40 mm Sin Contragiro / Without Counter-rotation
	OM 352A 6 Cil Diesel	01/80	12/90	<b>NKBO0500</b>	Engrenagens de 40 mm Sem Contagiro / Engrenajes de 40 mm Sin Contragiro / Without Counter-rotation

**FORD**

4600 Trator Ford	3 Cil Diesel	01/50	12/07	<b>NKBO0229</b>	
	4 Cil Diesel	01/50	12/07	<b>NKBO0229</b>	
4610 Trator Ford	3 Cil Diesel	01/50	12/07	<b>NKBO0229</b>	
	4 Cil Diesel	01/50	12/07	<b>NKBO0229</b>	
5600 Trator Ford	3 Cil Diesel	01/50	12/07	<b>NKBO0229</b>	
	4 Cil Diesel	01/50	12/07	<b>NKBO0229</b>	
5610 Trator Ford	3 Cil Diesel	01/50	12/07	<b>NKBO0229</b>	
	4 Cil Diesel	01/50	12/07	<b>NKBO0229</b>	
6600 Trator Ford	3 Cil Diesel	01/50	12/07	<b>NKBO0229</b>	
	4 Cil Diesel	01/50	12/07	<b>NKBO0229</b>	
6610 Trator Ford	Ford 4 Cil Diesel	01/50	12/07	<b>NKBO0230</b>	
7610 Trator Ford	Ford 4 Cil Diesel	01/50	12/07	<b>NKBO0230</b>	

**IDEAL**

CA1140	MWM D226 4 Cil Diesel	01/80	12/86	<b>NKBO0600</b>	
CA1170	MWM D225 6 Cil Diesel	01/86	12/96	<b>NKBO0600</b>	
	MWM D229 6 Cil Diesel	01/86	12/96	<b>NKBO0600</b>	
CA1175	MWM D225 6 Cil Diesel	01/86	12/96	<b>NKBO0600</b>	



**Máquinas Agrícolas & Fora de Estrada / Vehiculos Fuera de Carretera / Off Highway**

**IDEAL**

CA1175	MWM D229 6 Cil Diesel	01/86	12/96	<b>NKBO0600</b>	
CA875	MWM D226 4 Cil Diesel	01/80	12/86	<b>NKBO0600</b>	
Colheitadeira	OM 366 6 Cil Diesel	01/80	12/90	<b>NKBO0505</b>	Engrenagens de 40 mm / Engrenajes de 40 mm / 40 mm Gears
	OM 366 6 Cil Diesel	01/80	12/90	<b>NKBO0510</b>	Engrenagens de 50 mm / Engrenajes de 50 mm / 50 mm Gears

**SANTA MATILDE**

300	Perkins 4203 Diesel	01/79	01/89	<b>NKBO0405</b>	
	Perkins 4236 4 Cil Diesel	01/79	01/89	<b>NKBO0400</b>	
	Perkins 4248 4 Cil Diesel	01/79	01/89	<b>NKBO0400</b>	
400	Perkins 4203 Diesel	01/79	01/89	<b>NKBO0405</b>	
	Perkins 4236 4 Cil Diesel	01/79	01/89	<b>NKBO0400</b>	
	Perkins 4248 4 Cil Diesel	01/79	01/89	<b>NKBO0400</b>	
500(CR)	Perkins 4203 Diesel	01/79	12/89	<b>NKBO0405</b>	
SM 1200	MWM D225 6 Cil Diesel	01/78	12/88	<b>NKBO0600</b>	
	MWM D229 6 Cil Diesel	01/78	12/88	<b>NKBO0600</b>	
SM 5105	MWM D225 6 Cil Diesel	01/78	12/88	<b>NKBO0600</b>	
	MWM D229 6 Cil Diesel	01/78	12/88	<b>NKBO0600</b>	
SM3000C	Perkins 4203 Diesel	01/79	12/89	<b>NKBO0405</b>	
	Perkins 4236 4 Cil Diesel	01/79	12/89	<b>NKBO0400</b>	
	Perkins 4248 4 Cil Diesel	01/79	12/89	<b>NKBO0400</b>	

**VALMET**

118	MWM D229 6 Cil Diesel	01/83	12/86	<b>NKBO0600</b>	
138.4	MWM D229 6 Cil Diesel	01/83	12/86	<b>NKBO0600</b>	
880TA	MWM D225 6 Cil Diesel	01/77	12/80	<b>NKBO0600</b>	Florestal / Florestal / Florestal
885	MWM D229 4 Cil Diesel	01/87	01/92	<b>NKBO0600</b>	
980.4	MWM D229 4 Cil Diesel	01/86	12/96	<b>NKBO0600</b>	

**Caminhões & Ônibus / Camiones y Autobuses / Heavy Trucks & Buses**

**AGRALE**

6000	4.07T 4 CIL.	01/01	12/05	<b>NKBO0773</b>	
	4.07T 6 CIL.	01/01	12/05	<b>NKBO0773</b>	
	4.07TCA 4 CIL.	01/01	12/05	<b>NKBO0773</b>	
	4.07TCA 6 CIL.	01/01	12/05	<b>NKBO0773</b>	
	6.07T 4 CIL.	01/01	12/05	<b>NKBO0773</b>	
	6.07T 6 CIL.	01/01	12/05	<b>NKBO0773</b>	
	6.07TCA 4 CIL.	01/01	12/05	<b>NKBO0773</b>	
	6.07TCA 6 CIL.	01/01	12/05	<b>NKBO0773</b>	
7000	MWM 4.10	01/50	12/11	<b>NKBO0771</b>	Engrenagem 15°
	MWM 4.10T	01/50	12/11	<b>NKBO0771</b>	Engrenagem 15°
	MWM 4.10TCA	01/50	12/11	<b>NKBO0771</b>	Engrenagem 15°
	MWM 6.10	01/50	12/11	<b>NKBO0771</b>	Engrenagem 15°
	MWM 6.10T	01/50	12/11	<b>NKBO0771</b>	Engrenagem 15°
	MWM 6.10TCA	01/50	12/11	<b>NKBO0771</b>	Engrenagem 15°

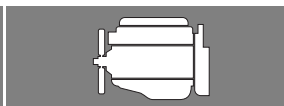

**Caminhões & Ônibus / Camiones y Autobuses / Heavy Trucks & Buses**

**AGRALE**

7500	MWM 4.10	01/50	12/11	<b>NKBO0771</b>	Engrenagem 15°
	MWM 4.10T	01/50	12/11	<b>NKBO0771</b>	Engrenagem 15°
	MWM 4.10TCA	01/50	12/11	<b>NKBO0771</b>	Engrenagem 15°
	MWM 6.10	01/50	12/11	<b>NKBO0771</b>	Engrenagem 15°
	MWM 6.10T	01/50	12/11	<b>NKBO0771</b>	Engrenagem 15°
	MWM 6.10TCA	01/50	12/11	<b>NKBO0771</b>	Engrenagem 15°
8500	MWM 4.10	01/50	12/11	<b>NKBO0771</b>	Engrenagem 15°
	MWM 4.10T	01/50	12/11	<b>NKBO0771</b>	Engrenagem 15°
	MWM 4.10TCA	01/50	12/11	<b>NKBO0771</b>	Engrenagem 15°
	MWM 6.10	01/50	12/11	<b>NKBO0771</b>	Engrenagem 15°
	MWM 6.10T	01/50	12/11	<b>NKBO0771</b>	Engrenagem 15°
	MWM 6.10TCA	01/50	12/11	<b>NKBO0771</b>	Engrenagem 15°
BX 130	MWM D229 6 Cil Diesel	01/80	12/90	<b>NKBO0600</b>	
BX 490	MWM D229 4 Cil Diesel	01/80	12/90	<b>NKBO0600</b>	
BX 90	MWM D229 4 Cil Diesel	01/80	12/90	<b>NKBO0600</b>	
TX1600	MWM D229 3 Cil Diesel	01/84	12/96	<b>NKBO0600</b>	
TX1800	MWM D229 4 Cil Diesel	01/89	12/99	<b>NKBO0600</b>	

**CHRYSLER**

D 100	Perkins 4236 4 Cil Diesel	01/70	12/81	<b>NKBO0400</b>	
D 400	Perkins 4236 4 Cil Diesel	01/70	12/81	<b>NKBO0400</b>	

**FORD**

1215 Cargo	5.9 Diesel	01/92	12/02	<b>NKBO0789</b>	Altura do rotor 16,80 mm
1217 Cargo	5.9 Diesel	01/99	12/02	<b>NKBO0789</b>	Altura do rotor 16,80 mm
1317 Cargo	3.9L 4 Cil Diesel	01/05	12/11	<b>NKBO0250</b>	Altura do rotor 13,64mm
1415 Cargo	5.9 Diesel	01/92	12/02	<b>NKBO0789</b>	Altura do rotor 16,80 mm
1417 Cargo	5.9 Diesel	01/02	12/02	<b>NKBO0789</b>	Altura do rotor 16,80 mm
1421 Cargo	5.9 Diesel	01/99	12/99	<b>NKBO0789</b>	Altura do rotor 16,80 mm
1422 Cargo	Cummins 6CT 8.3 Diesel	01/80	12/90	<b>NKBO0788</b>	Altura do rotor 21,48mm
	Cummins 6CTA 8.3 Diesel	01/80	12/90	<b>NKBO0788</b>	Altura do rotor 21,48mm
	Cummins 6CTAA 8.3 Dese	01/80	12/90	<b>NKBO0788</b>	Altura do rotor 21,48mm
1517 Cargo	3.9L 4 Cil Diesel	01/05	12/11	<b>NKBO0250</b>	Altura do rotor 13,64mm
1617 Cargo	5.9 Diesel	01/93	12/02	<b>NKBO0789</b>	Altura do rotor 16,80 mm
	Cummins 6CT 8.3 Diesel	01/76	12/86	<b>NKBO0788</b>	Altura do rotor 21,48mm
	Cummins 6CTA 8.3 Diesel	01/76	12/86	<b>NKBO0788</b>	Altura do rotor 21,48mm
	Cummins 6CTAA 8.3 Dese	01/76	12/86	<b>NKBO0788</b>	Altura do rotor 21,48mm
1621 Cargo	5.9 Diesel	01/99	12/02	<b>NKBO0789</b>	Altura do rotor 16,80 mm
1622 Cargo	Cummins 6CT 8.3 Diesel	01/80	12/90	<b>NKBO0788</b>	Altura do rotor 21,48mm
	Cummins 6CTA 8.3 Diesel	01/80	12/90	<b>NKBO0788</b>	Altura do rotor 21,48mm
	Cummins 6CTAA 8.3 Dese	01/80	12/90	<b>NKBO0788</b>	Altura do rotor 21,48mm
1630 Cargo	Cummins 6CT 8.3 Diesel	01/91	12/01	<b>NKBO0788</b>	Altura do rotor 21,48mm
	Cummins 6CTA 8.3 Diesel	01/91	12/01	<b>NKBO0788</b>	Altura do rotor 21,48mm



**Caminhões & Ônibus / Camiones y Autobuses / Heavy Trucks & Buses**

**FORD**

1630 Cargo	Cummins 6CTAA 8.3 Dese	01/91	12/01	<b>NKBO0788</b>	Altura do rotor 21,48mm
1717 Cargo	3.9L 4 Cil Diesel	01/05	12/11	<b>NKBO0250</b>	Altura do rotor 13,64mm
1721 Cargo	5.9 Diesel	01/99	12/02	<b>NKBO0789</b>	Altura do rotor 16,80 mm
1722 Cargo	5.9L 4 Cil Diesel	01/06	12/11	<b>NKBO0255</b>	Altura do rotor 16,80mm
1731 Cargo	Cummins 6CT 8.3 Diesel	01/03	12/05	<b>NKBO0788</b>	Altura do rotor 21,48mm
	Cummins 6CTA 8.3 Diesel	01/03	12/05	<b>NKBO0788</b>	Altura do rotor 21,48mm
	Cummins 6CTAA 8.3 Dese	01/03	12/05	<b>NKBO0788</b>	Altura do rotor 21,48mm
2322 Cargo	Cummins 6CT 8.3 Diesel	01/80	12/90	<b>NKBO0788</b>	Altura do rotor 21,48mm
	Cummins 6CTA 8.3 Diesel	01/80	12/90	<b>NKBO0788</b>	Altura do rotor 21,48mm
	Cummins 6CTAA 8.3 Dese	01/80	12/90	<b>NKBO0788</b>	Altura do rotor 21,48mm
2422 Cargo	5.9L 4 Cil Diesel	01/06	12/11	<b>NKBO0255</b>	Altura do rotor 16,80mm
	Cummins 6CT 8.3 Diesel	01/80	12/90	<b>NKBO0788</b>	Altura do rotor 21,48mm
	Cummins 6CTA 8.3 Diesel	01/80	12/90	<b>NKBO0788</b>	Altura do rotor 21,48mm
	Cummins 6CTAA 8.3 Dese	01/80	12/90	<b>NKBO0788</b>	Altura do rotor 21,48mm
2425 Cargo	Cummins 6CT 8.3 Diesel	01/97	12/03	<b>NKBO0788</b>	Altura do rotor 21,48mm
	Cummins 6CTA 8.3 Diesel	01/97	12/03	<b>NKBO0788</b>	Altura do rotor 21,48mm
	Cummins 6CTAA 8.3 Dese	01/97	12/03	<b>NKBO0788</b>	Altura do rotor 21,48mm
2428 Cargo	5.9L 4 Cil Diesel	01/06	12/11	<b>NKBO0255</b>	Altura do rotor 16,80mm
2622 Cargo	5.9L 4 Cil Diesel	01/06	12/11	<b>NKBO0255</b>	Altura do rotor 16,80mm
2628 Cargo	5.9L 4 Cil Diesel	01/06	12/11	<b>NKBO0255</b>	Altura do rotor 16,80mm
2630 Cargo	Cummins 6CT 8.3 Diesel	01/98	12/02	<b>NKBO0788</b>	Altura do rotor 21,48mm
	Cummins 6CTA 8.3 Diesel	01/98	12/02	<b>NKBO0788</b>	Altura do rotor 21,48mm
	Cummins 6CTAA 8.3 Dese	01/98	12/02	<b>NKBO0788</b>	Altura do rotor 21,48mm
3224 Cargo	Cummins 6CT 8.3 Diesel	01/80	12/90	<b>NKBO0788</b>	Altura do rotor 21,48mm
	Cummins 6CTA 8.3 Diesel	01/80	12/90	<b>NKBO0788</b>	Altura do rotor 21,48mm
	Cummins 6CTAA 8.3 Dese	01/80	12/90	<b>NKBO0788</b>	Altura do rotor 21,48mm
3530 Cargo	Cummins 6CT 8.3 Diesel	01/80	12/90	<b>NKBO0788</b>	Altura do rotor 21,48mm
	Cummins 6CTA 8.3 Diesel	01/80	12/90	<b>NKBO0788</b>	Altura do rotor 21,48mm
	Cummins 6CTAA 8.3 Dese	01/80	12/90	<b>NKBO0788</b>	Altura do rotor 21,48mm
4030 Cargo	Cummins 6CT 8.3 Diesel	01/94	12/02	<b>NKBO0788</b>	Altura do rotor 21,48mm
	Cummins 6CTA 8.3 Diesel	01/94	12/02	<b>NKBO0788</b>	Altura do rotor 21,48mm
	Cummins 6CTAA 8.3 Dese	01/94	12/02	<b>NKBO0788</b>	Altura do rotor 21,48mm
712 Cargo	3.9 Diesel			<b>NKBO0235</b>	Altura do rotor 12,20 mm
814 Cargo	3.9 Diesel			<b>NKBO0235</b>	Altura do rotor 12,20 mm
815 Cargo	3.9 Diesel			<b>NKBO0235</b>	Altura do rotor 12,20 mm
	3.9L 4 Cil Diesel	01/05	12/11	<b>NKBO0250</b>	Altura do rotor 13,64mm
915 Cargo	3.9 Diesel			<b>NKBO0235</b>	Altura do rotor 12,20 mm
B1618	MWM 6.10TCA	01/99	12/00	<b>NKBO0771</b>	Engrenagem 15°
B1621	MWM 6.10TCA	01/99	12/00	<b>NKBO0771</b>	Engrenagem 15°
F 12000	5.9 Diesel	01/98	12/99	<b>NKBO0789</b>	Altura do rotor 16,80 mm
	MWM D229 6 Cil Diesel	01/85	12/95	<b>NKBO0600</b>	



**Caminhões & Ônibus / Camiones y Autobuses / Heavy Trucks & Buses**

**FORD**

F 13000	MWM D229 6 Cil Diesel	01/85	12/95	<b>NKBO0600</b>	
F 14000	5.9 Diesel	01/98	12/99	<b>NKBO0789</b>	Altura do rotor 16,80 mm
F 16000	5.9 Diesel	01/98	12/99	<b>NKBO0789</b>	Altura do rotor 16,80 mm
F 19000	MWM D229 6 Cil Diesel	01/85	12/95	<b>NKBO0600</b>	
F 2000	MWM D229 4 Cil Diesel	01/90	12/92	<b>NKBO0600</b>	
F 21000	MWM D229 6 Cil Diesel	01/85	12/95	<b>NKBO0600</b>	
F 22000	MWM D229 6 Cil Diesel	01/85	12/95	<b>NKBO0600</b>	
F 250	4.2 6 CIL. TURBO	01/99	12/06	<b>NKBO0773</b>	
	3.9 Diesel	01/99	01/11	<b>NKBO0235</b>	Altura do rotor 12,20 mm
F 4000	3.9 Diesel			<b>NKBO0235</b>	Altura do rotor 12,20 mm
	Ford 4 Cil Diesel	01/84	12/89	<b>NKBO0230</b>	
	MWM D229 4 Cil Diesel	01/80	12/92	<b>NKBO0600</b>	
FB 4000	MWM D229 4 Cil Diesel	01/80	12/92	<b>NKBO0600</b>	

**GENERAL MOTORS**

12000	Perkins 4236 4 Cil Diesel	01/85	01/95	<b>NKBO0400</b>	
14000	Perkins 4236 4 Cil Diesel	01/85	01/95	<b>NKBO0400</b>	
6.100	4.07T 4 CIL.	01/96	12/00	<b>NKBO0773</b>	
6.150	4.07T 4 CIL.	01/96	12/00	<b>NKBO0773</b>	
A/C/D 40	Perkins 4236 4 Cil Diesel	01/85	12/95	<b>NKBO0400</b>	
D40	Perkins 4236 4 Cil Diesel	01/85	12/95	<b>NKBO0400</b>	

**IVECO**

Eurocargo	MWM 4.10	01/50	12/11	<b>NKBO0771</b>	Engrenagem 15°
	MWM 4.10T	01/50	12/11	<b>NKBO0771</b>	Engrenagem 15°
	MWM 4.10TCA	01/50	12/11	<b>NKBO0771</b>	Engrenagem 15°
	MWM 6.10	01/50	12/11	<b>NKBO0771</b>	Engrenagem 15°
	MWM 6.10T	01/50	12/11	<b>NKBO0771</b>	Engrenagem 15°
	MWM 6.10TCA	01/50	12/11	<b>NKBO0771</b>	Engrenagem 15°

**MERCEDES BENZ**

1111	OM 352 6 Cil Diesel	01/69	12/70	<b>NKBO0500</b>	Engrenagens de 40 mm Sem Contagiro / Engrenajes de 40 mm Sin Contragiro / Without Counter-rotation
1113	OM 352 6 Cil Diesel	01/69	12/89	<b>NKBO0500</b>	Engrenagens de 40 mm Sem Contagiro / Engrenajes de 40 mm Sin Contragiro / Without Counter-rotation
	OM 352A 6 Cil Diesel	01/74	12/89	<b>NKBO0500</b>	Engrenagens de 40 mm Sem Contagiro / Engrenajes de 40 mm Sin Contragiro / Without Counter-rotation
1116	OM 352 6 Cil Diesel	01/69	12/70	<b>NKBO0500</b>	Engrenagens de 40 mm Sem Contagiro / Engrenajes de 40 mm Sin Contragiro / Without Counter-rotation
	OM 352A 6 Cil Diesel	01/86	12/89	<b>NKBO0500</b>	Engrenagens de 40 mm Sem Contagiro / Engrenajes de 40 mm Sin Contragiro / Without Counter-rotation
1214	OM 366 6 Cil Diesel	01/89	12/99	<b>NKBO0510</b>	Engrenagens de 50 mm / Engrenajes de 50 mm / 50 mm Gears
	OM 366 6 Cil Diesel	01/89	12/99	<b>NKBO0505</b>	Engrenagens de 40 mm / Engrenajes de 40 mm / 40 mm Gears
1218	OM 366 6 Cil Diesel	01/89	12/99	<b>NKBO0505</b>	Engrenagens de 40 mm / Engrenajes de 40 mm / 40 mm Gears
	OM 366 6 Cil Diesel	01/89	12/99	<b>NKBO0510</b>	Engrenagens de 50 mm / Engrenajes de 50 mm / 50 mm Gears



**Caminhões & Ônibus / Camiones y Autobuses / Heavy Trucks & Buses**

**MERCEDES BENZ**

1313	OM 352 6 Cil Diesel	01/69	12/70	<b>NKBO0500</b>	Engrenagens de 40 mm Sem Contagiado / Engrenajes de 40 mm Sin Contagiado / Without Counter-rotation
	OM 352A 6 Cil Diesel	01/86	12/89	<b>NKBO0500</b>	Engrenagens de 40 mm Sem Contagiado / Engrenajes de 40 mm Sin Contagiado / Without Counter-rotation
1315	OM 366 6 Cil Diesel	01/89	12/96	<b>NKBO0505</b>	Engrenagens de 40 mm / Engrenajes de 40 mm / 40 mm Gears
	OM 366 6 Cil Diesel	01/89	12/96	<b>NKBO0510</b>	Engrenagens de 50 mm / Engrenajes de 50 mm / 50 mm Gears
1316	OM 352 6 Cil Diesel	01/69	12/70	<b>NKBO0500</b>	Engrenagens de 40 mm Sem Contagiado / Engrenajes de 40 mm Sin Contagiado / Without Counter-rotation
	OM 352A 6 Cil Diesel	01/86	12/89	<b>NKBO0500</b>	Engrenagens de 40 mm Sem Contagiado / Engrenajes de 40 mm Sin Contagiado / Without Counter-rotation
1318	OM 366 6 Cil Diesel	01/89	12/01	<b>NKBO0510</b>	Engrenagens de 50 mm / Engrenajes de 50 mm / 50 mm Gears
	OM 366 6 Cil Diesel	01/89	12/01	<b>NKBO0505</b>	Engrenagens de 40 mm / Engrenajes de 40 mm / 40 mm Gears
1414	OM 366 6 Cil Diesel	01/89	12/01	<b>NKBO0510</b>	Engrenagens de 50 mm / Engrenajes de 50 mm / 50 mm Gears
	OM 366 6 Cil Diesel	01/89	12/01	<b>NKBO0505</b>	Engrenagens de 40 mm / Engrenajes de 40 mm / 40 mm Gears
1418	OM 366 6 Cil Diesel	01/89	12/99	<b>NKBO0505</b>	Engrenagens de 40 mm / Engrenajes de 40 mm / 40 mm Gears
	OM 366 6 Cil Diesel	01/89	12/99	<b>NKBO0510</b>	Engrenagens de 50 mm / Engrenajes de 50 mm / 50 mm Gears
1418 Atego	OM 906LA 6 Cil Diesel	01/03	12/11	<b>NKBO0550</b>	
1513	OM 352 6 Cil Diesel	01/69	12/70	<b>NKBO0500</b>	Engrenagens de 40 mm Sem Contagiado / Engrenajes de 40 mm Sin Contagiado / Without Counter-rotation
	OM 352A 6 Cil Diesel	01/86	12/89	<b>NKBO0500</b>	Engrenagens de 40 mm Sem Contagiado / Engrenajes de 40 mm Sin Contagiado / Without Counter-rotation
1516	OM 352 6 Cil Diesel	01/69	12/70	<b>NKBO0500</b>	Engrenagens de 40 mm Sem Contagiado / Engrenajes de 40 mm Sin Contagiado / Without Counter-rotation
	OM 352A 6 Cil Diesel	01/86	12/89	<b>NKBO0500</b>	Engrenagens de 40 mm Sem Contagiado / Engrenajes de 40 mm Sin Contagiado / Without Counter-rotation
1518 Atego	OM 906LA 6 Cil Diesel	01/03	12/11	<b>NKBO0550</b>	
1519	OM 355 6 Cil Diesel	01/73	12/87	<b>NKBO0515</b>	Com engrenagens de 55mm
1520	OM 355 6 Cil Diesel	01/87	12/05	<b>NKBO0515</b>	Com engrenagens de 55mm
1614	OM 366 6 Cil Diesel	01/89	12/99	<b>NKBO0505</b>	Engrenagens de 40 mm / Engrenajes de 40 mm / 40 mm Gears
	OM 366 6 Cil Diesel	01/89	12/99	<b>NKBO0510</b>	Engrenagens de 50 mm / Engrenajes de 50 mm / 50 mm Gears
1618	OM 366 6 Cil Diesel	01/89	12/99	<b>NKBO0505</b>	Engrenagens de 40 mm / Engrenajes de 40 mm / 40 mm Gears
	OM 366 6 Cil Diesel	01/89	12/99	<b>NKBO0510</b>	Engrenagens de 50 mm / Engrenajes de 50 mm / 50 mm Gears
1620	OM 366 6 Cil Diesel	01/89	12/99	<b>NKBO0505</b>	Engrenagens de 40 mm / Engrenajes de 40 mm / 40 mm Gears
	OM 366 6 Cil Diesel	01/89	12/99	<b>NKBO0510</b>	Engrenagens de 50 mm / Engrenajes de 50 mm / 50 mm Gears
1621	OM 366 6 Cil Diesel	01/89	12/99	<b>NKBO0505</b>	Engrenagens de 40 mm / Engrenajes de 40 mm / 40 mm Gears
	OM 366 6 Cil Diesel	01/89	12/99	<b>NKBO0510</b>	Engrenagens de 50 mm / Engrenajes de 50 mm / 50 mm Gears
1625	OM 449 A Diesel	01/85	12/95	<b>NKBO0520</b>	
1630	OM 449 A Diesel	01/85	12/95	<b>NKBO0520</b>	
	OM 449 LA Diesel	01/96	12/06	<b>NKBO0520</b>	
1714	OM 366 6 Cil Diesel	01/89	12/99	<b>NKBO0510</b>	Engrenagens de 50 mm / Engrenajes de 50 mm / 50 mm Gears
	OM 366 6 Cil Diesel	01/89	12/99	<b>NKBO0505</b>	Engrenagens de 40 mm / Engrenajes de 40 mm / 40 mm Gears
1718	OM 366 6 Cil Diesel	01/89	12/99	<b>NKBO0505</b>	Engrenagens de 40 mm / Engrenajes de 40 mm / 40 mm Gears
	OM 366 6 Cil Diesel	01/89	12/99	<b>NKBO0510</b>	Engrenagens de 50 mm / Engrenajes de 50 mm / 50 mm Gears
1718 Atego	OM 906LA 6 Cil Diesel	01/03	12/11	<b>NKBO0550</b>	

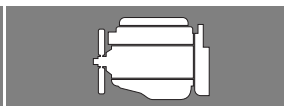

**Caminhões & Ônibus / Camiones y Autobuses / Heavy Trucks & Buses**

**MERCEDES BENZ**

1721	OM 366 6 Cil Diesel	01/89	12/99	<b>NKBO0505</b>	Engrenagens de 40 mm / Engranajes de 40 mm / 40 mm Gears
	OM 366 6 Cil Diesel	01/89	12/99	<b>NKBO0510</b>	Engrenagens de 50 mm / Engranajes de 50 mm / 50 mm Gears
1725 Atego	OM 906LA 6 Cil Diesel	01/03	12/11	<b>NKBO0550</b>	
1728 Atego	OM 906LA 6 Cil Diesel	01/03	12/11	<b>NKBO0550</b>	
1819	OM 355 6 Cil Diesel	01/80	12/90	<b>NKBO0515</b>	Com engrenagens de 55mm
1820	OM 355 6 Cil Diesel	01/96	12/05	<b>NKBO0515</b>	Com engrenagens de 55mm
1924	OM 355 6 Cil Diesel	01/76	12/83	<b>NKBO0515</b>	Com engrenagens de 55mm
1929	OM 355 6 Cil Diesel	01/83	12/87	<b>NKBO0515</b>	Com engrenagens de 55mm
1933 Atego	OM 906LA 6 Cil Diesel	01/03	12/11	<b>NKBO0550</b>	
1933 Axor	OM 926LA 6 Cil Diesel	01/03	12/11	<b>NKBO0550</b>	
1935	OM 447 LA Diesel	01/90	12/06	<b>NKBO0520</b>	Engrenagens de 34 mm / Engranajes de 34 mm / 34 mm Gears
1941	OM 447 LA Diesel	01/90	12/06	<b>NKBO0520</b>	Engrenagens de 34 mm / Engranajes de 34 mm / 34 mm Gears
2013	OM 352 6 Cil Diesel	01/69	12/70	<b>NKBO0500</b>	Engrenagens de 40 mm Sem Contagiado / Engranajes de 40 mm Sin Contagiado / Without Counter-rotation
	OM 352A 6 Cil Diesel	01/86	12/89	<b>NKBO0500</b>	Engrenagens de 40 mm Sem Contagiado / Engranajes de 40 mm Sin Contagiado / Without Counter-rotation
2016	OM 352 6 Cil Diesel	01/69	12/70	<b>NKBO0500</b>	Engrenagens de 40 mm Sem Contagiado / Engranajes de 40 mm Sin Contagiado / Without Counter-rotation
	OM 352A 6 Cil Diesel	01/86	12/89	<b>NKBO0500</b>	Engrenagens de 40 mm Sem Contagiado / Engranajes de 40 mm Sin Contagiado / Without Counter-rotation
2035 Axor	OM457 LA 6 Cil Diesel	01/05	12/11	<b>NKBO0540</b>	Engrenagem 43 Dentes / Engranaje 43 dientes / Gear 43 Teeth
2040 Axor	OM457 LA 6 Cil Diesel	01/05	12/11	<b>NKBO0540</b>	Engrenagem 43 Dentes / Engranaje 43 dientes / Gear 43 Teeth
2044 Axor	OM457 LA 6 Cil Diesel	01/05	12/11	<b>NKBO0540</b>	Engrenagem 43 Dentes / Engranaje 43 dientes / Gear 43 Teeth
2213	OM 352 6 Cil Diesel	01/69	12/70	<b>NKBO0500</b>	Engrenagens de 40 mm Sem Contagiado / Engranajes de 40 mm Sin Contagiado / Without Counter-rotation
	OM 352A 6 Cil Diesel	01/86	12/89	<b>NKBO0500</b>	Engrenagens de 40 mm Sem Contagiado / Engranajes de 40 mm Sin Contagiado / Without Counter-rotation
2216	OM 352 6 Cil Diesel	01/69	12/70	<b>NKBO0500</b>	Engrenagens de 40 mm Sem Contagiado / Engranajes de 40 mm Sin Contagiado / Without Counter-rotation
	OM 352A 6 Cil Diesel	01/86	12/89	<b>NKBO0500</b>	Engrenagens de 40 mm Sem Contagiado / Engranajes de 40 mm Sin Contagiado / Without Counter-rotation
2219	OM 355 6 Cil Diesel	01/78	12/87	<b>NKBO0515</b>	Com engrenagens de 55mm
2220	OM 355 6 Cil Diesel	01/87	12/91	<b>NKBO0515</b>	Com engrenagens de 55mm
2314	OM 366 6 Cil Diesel	01/89	12/99	<b>NKBO0505</b>	Engrenagens de 40 mm / Engranajes de 40 mm / 40 mm Gears
	OM 366 6 Cil Diesel	01/89	12/99	<b>NKBO0510</b>	Engrenagens de 50 mm / Engranajes de 50 mm / 50 mm Gears
2318	OM 366 6 Cil Diesel	01/89	12/99	<b>NKBO0510</b>	Engrenagens de 50 mm / Engranajes de 50 mm / 50 mm Gears
	OM 366 6 Cil Diesel	01/89	12/99	<b>NKBO0505</b>	Engrenagens de 40 mm / Engranajes de 40 mm / 40 mm Gears
2325	OM 449 A Diesel	01/85	12/95	<b>NKBO0520</b>	
	OM 449 LA Diesel	01/96	01/06	<b>NKBO0520</b>	
2418	OM 366 6 Cil Diesel	01/89	12/99	<b>NKBO0505</b>	Engrenagens de 40 mm / Engranajes de 40 mm / 40 mm Gears
	OM 366 6 Cil Diesel	01/89	12/99	<b>NKBO0510</b>	Engrenagens de 50 mm / Engranajes de 50 mm / 50 mm Gears
2425 Atego	OM 906LA 6 Cil Diesel	01/03	12/11	<b>NKBO0550</b>	
2428 Atego	OM 906LA 6 Cil Diesel	01/03	12/11	<b>NKBO0550</b>	





**Caminhões & Ônibus / Camiones y Autobuses / Heavy Trucks & Buses**

**MERCEDES BENZ**

2533 Axor	OM 926LA 6 Cil Diesel	01/03	12/11	<b>NKBO0550</b>	
2540 Axor	OM457 LA 6 Cil Diesel	01/05	12/11	<b>NKBO0540</b>	Engrenagem 43 Dentes / Engranaje 43 dientes / Gear 43 Teeth
2544 Axor	OM457 LA 6 Cil Diesel	01/05	12/11	<b>NKBO0540</b>	Engrenagem 43 Dentes / Engranaje 43 dientes / Gear 43 Teeth
2635	OM 447 LA Diesel	01/96	12/06	<b>NKBO0520</b>	Engrenagens de 34 mm / Engranajes de 34 mm / 34 mm Gears
2640 Axor	OM457 LA 6 Cil Diesel	01/05	12/11	<b>NKBO0540</b>	Engrenagem 43 Dentes / Engranaje 43 dientes / Gear 43 Teeth
2644 Axor	OM457 LA 6 Cil Diesel	01/05	12/11	<b>NKBO0540</b>	Engrenagem 43 Dentes / Engranaje 43 dientes / Gear 43 Teeth
2826 Axor	OM 926LA 6 Cil Diesel	01/03	12/11	<b>NKBO0550</b>	
2831 Axor	OM 926LA 6 Cil Diesel	01/03	12/11	<b>NKBO0550</b>	
3340 Axor	OM457 LA 6 Cil Diesel	01/05	12/11	<b>NKBO0540</b>	Engrenagem 43 Dentes / Engranaje 43 dientes / Gear 43 Teeth
3344 Axor	OM457 LA 6 Cil Diesel	01/05	12/11	<b>NKBO0540</b>	Engrenagem 43 Dentes / Engranaje 43 dientes / Gear 43 Teeth
4140 Axor	OM457 LA 6 Cil Diesel	01/05	12/11	<b>NKBO0540</b>	Engrenagem 43 Dentes / Engranaje 43 dientes / Gear 43 Teeth
4144 Axor	OM457 LA 6 Cil Diesel	01/05	12/11	<b>NKBO0540</b>	Engrenagem 43 Dentes / Engranaje 43 dientes / Gear 43 Teeth
608	OM 314 4 Cil Diesel	01/72	12/90	<b>NKBO0500</b>	Engrenagens de 40 mm Sem Contagiado / Engrenajes de 40 mm Sin Contagiado / Without Counter-rotation
709	OM 364 4 Cil Diesel	01/90	01/95	<b>NKBO0505</b>	Engrenagens de 40 mm / Engrenajes de 40 mm / 40 mm Gears
712	OM 364A 4 Cil Diesel	01/90	01/95	<b>NKBO0505</b>	Engrenagens de 40 mm / Engrenajes de 40 mm / 40 mm Gears
809	OM 364 4 Cil Diesel	01/90	12/98	<b>NKBO0505</b>	Engrenagens de 40 mm / Engrenajes de 40 mm / 40 mm Gears
812	OM 364 4 Cil Diesel	01/90	12/98	<b>NKBO0505</b>	Engrenagens de 40 mm / Engrenajes de 40 mm / 40 mm Gears
	OM 364A 4 Cil Diesel	01/90	01/95	<b>NKBO0505</b>	Engrenagens de 40 mm / Engrenajes de 40 mm / 40 mm Gears
912	OM 364A 4 Cil Diesel	01/90	12/06	<b>NKBO0505</b>	Engrenagens de 40 mm / Engrenajes de 40 mm / 40 mm Gears
914	OM 364A 4 Cil Diesel	01/81	12/06	<b>NKBO0505</b>	Engrenagens de 40 mm / Engrenajes de 40 mm / 40 mm Gears
915C Accelo	OM 904LA 6 Cil Diesel	01/03	12/11	<b>NKBO0550</b>	
O352	OM 352 6 Cil Diesel	01/70	12/89	<b>NKBO0500</b>	Engrenagens de 40 mm Sem Contagiado / Engrenajes de 40 mm Sin Contagiado / Without Counter-rotation
	OM 352A 6 Cil Diesel	01/86	12/89	<b>NKBO0500</b>	Engrenagens de 40 mm Sem Contagiado / Engrenajes de 40 mm Sin Contagiado / Without Counter-rotation
O362	OM 352 6 Cil Diesel	01/74	12/89	<b>NKBO0500</b>	Engrenagens de 40 mm Sem Contagiado / Engrenajes de 40 mm Sin Contagiado / Without Counter-rotation
	OM 352A 6 Cil Diesel	01/74	12/89	<b>NKBO0500</b>	Engrenagens de 40 mm Sem Contagiado / Engrenajes de 40 mm Sin Contagiado / Without Counter-rotation
	OM352 6 Cil Diesel	01/74	12/89	<b>NKBO0530</b>	Com Conta-Giros e Engrenagem de 40mm
	OM352-A 6 Cil Diesel	01/74	12/89	<b>NKBO0535</b>	Com Conta-Giros e Engrenagem de 50mm Montado no motor a partir do nº 781.818
O364	OM 352 5/6 Cil Diesel	01/82	12/89	<b>NKBO0500</b>	Engrenagens de 40 mm Sem Contagiado / Engrenajes de 40 mm Sin Contagiado / Without Counter-rotation
	OM 352A 5/6 Cil Diesel	01/82	12/89	<b>NKBO0500</b>	Engrenagens de 40 mm Sem Contagiado / Engrenajes de 40 mm Sin Contagiado / Without Counter-rotation
	OM352 6 Cil Diesel	01/82	12/89	<b>NKBO0530</b>	Com Conta-Giros e Engrenagem de 40mm
O365	OM352 6 Cil Diesel	01/82	12/89	<b>NKBO0530</b>	Com Conta-Giros e Engrenagem de 40mm
O371	OM 366 6 Cil Diesel	01/89	12/99	<b>NKBO0505</b>	Engrenagens de 40 mm / Engrenajes de 40 mm / 40 mm Gears
	OM 366 6 Cil Diesel	01/89	12/99	<b>NKBO0510</b>	Engrenagens de 50 mm / Engrenajes de 50 mm / 50 mm Gears
O400	OM-447 6 Cil Diesel	01/95	12/05	<b>NKBO0520</b>	Engrenagens de 34 mm / Engranajes de 34 mm / 34 mm Gears

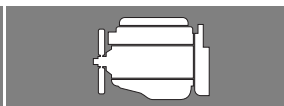

**Caminhões & Ônibus / Camiones y Autobuses / Heavy Trucks & Buses**

**MERCEDES BENZ**

OF1113	OM 352 6 Cil Diesel	01/82	12/89	<b>NKBO0500</b>	Engrenagens de 40 mm Sem Contagiro / Engrenajes de 40 mm Sin Contragiro / Without Counter-rotation
	OM 352A 6 Cil Diesel	01/82	12/89	<b>NKBO0500</b>	Engrenagens de 40 mm Sem Contagiro / Engrenajes de 40 mm Sin Contragiro / Without Counter-rotation
OF1115	OM 366 6 Cil Diesel	01/89	12/99	<b>NKBO0505</b>	Engrenagens de 40 mm / Engrenajes de 40 mm / 40 mm Gears
	OM 366 6 Cil Diesel	01/89	12/99	<b>NKBO0510</b>	Engrenagens de 50 mm / Engrenajes de 50 mm / 50 mm Gears
OF1313	OM 352 6 Cil Diesel	01/74	12/89	<b>NKBO0500</b>	Engrenagens de 40 mm Sem Contagiro / Engrenajes de 40 mm Sin Contragiro / Without Counter-rotation
	OM 352A 6 Cil Diesel	01/74	12/89	<b>NKBO0500</b>	Engrenagens de 40 mm Sem Contagiro / Engrenajes de 40 mm Sin Contragiro / Without Counter-rotation
	OM 366 6 Cil Diesel	01/89	12/99	<b>NKBO0505</b>	Engrenagens de 40 mm / Engrenajes de 40 mm / 40 mm Gears
	OM 366 6 Cil Diesel	01/89	12/99	<b>NKBO0510</b>	Engrenagens de 50 mm / Engrenajes de 50 mm / 50 mm Gears
OF1318	OM 366 6 Cil Diesel	01/89	12/99	<b>NKBO0505</b>	Engrenagens de 40 mm / Engrenajes de 40 mm / 40 mm Gears
	OM 366 6 Cil Diesel	01/89	12/99	<b>NKBO0510</b>	Engrenagens de 50 mm / Engrenajes de 50 mm / 50 mm Gears
OF1721	OM 366 6 Cil Diesel	01/80	12/90	<b>NKBO0505</b>	Engrenagens de 40 mm / Engrenajes de 40 mm / 40 mm Gears
	OM 366 6 Cil Diesel	01/80	12/90	<b>NKBO0510</b>	Engrenagens de 50 mm / Engrenajes de 50 mm / 50 mm Gears
OH1313	OM 352 6 Cil Diesel	01/82	12/89	<b>NKBO0500</b>	Engrenagens de 40 mm Sem Contagiro / Engrenajes de 40 mm Sin Contragiro / Without Counter-rotation
	OM 352A 6 Cil Diesel	01/82	12/89	<b>NKBO0500</b>	Engrenagens de 40 mm Sem Contagiro / Engrenajes de 40 mm Sin Contragiro / Without Counter-rotation
	OM352 6 Cil Diesel	01/82	12/89	<b>NKBO0530</b>	Com Conta-Giros e Engrenagem de 40mm
OH1314	OM352 6 Cil Diesel	01/82	12/89	<b>NKBO0530</b>	Com Conta-Giros e Engrenagem de 40mm
OH1316	OM 352 6 Cil Diesel	01/82	12/89	<b>NKBO0500</b>	Engrenagens de 40 mm Sem Contagiro / Engrenajes de 40 mm Sin Contragiro / Without Counter-rotation
	OM 352A 6 Cil Diesel	01/82	12/89	<b>NKBO0500</b>	Engrenagens de 40 mm Sem Contagiro / Engrenajes de 40 mm Sin Contragiro / Without Counter-rotation
	OM352-A 6 Cil Diesel	01/82	12/89	<b>NKBO0535</b>	Com Conta-Giros e Engrenagem de 50mm Montado no motor a partir do nº 781.818
OH1317	OM 366 6 Cil Diesel	01/89	12/99	<b>NKBO0505</b>	Engrenagens de 40 mm / Engrenajes de 40 mm / 40 mm Gears
	OM 366 6 Cil Diesel	01/89	12/99	<b>NKBO0510</b>	Engrenagens de 50 mm / Engrenajes de 50 mm / 50 mm Gears
OH1635	OM 447 LA Diesel	01/96	01/06	<b>NKBO0520</b>	Engrenagens de 34 mm / Engrenajes de 34 mm / 34 mm Gears

**SANTAL**

115	MWM D225 6 Cil Diesel	01/80	12/90	<b>NKBO0600</b>	
116	MWM D225 6 Cil Diesel	01/80	12/90	<b>NKBO0600</b>	

**SCANIA**

K124	DSC12 6 Cil	01/98	12/11	<b>NKBO0410</b>	
P114	DC11 / DC12 6 Cil	01/98	12/11	<b>NKBO0410</b>	
R114	DC11 / DC12 6 Cil	01/98	12/11	<b>NKBO0410</b>	
R124	DC11 / DC12 6 Cil	01/98	12/11	<b>NKBO0410</b>	
R143	8 Cil Diesel	01/70	12/09	<b>NKBO0415</b>	Haste 19,8mm
R164	DC11 / DC12 6 Cil	01/98	12/11	<b>NKBO0410</b>	
T114	DC11 / DC12 6 Cil	01/98	12/11	<b>NKBO0410</b>	
T124	DC11 / DC12 6 Cil	01/98	12/11	<b>NKBO0410</b>	
T143	8 Cil Diesel	01/70	12/09	<b>NKBO0415</b>	Haste 19,8mm



**Caminhões & Ônibus / Camiones y Autobuses / Heavy Trucks & Buses**

**VOLARE**

A 6	4.07T 4 CIL.	01/99	12/06	<b>NKBO0773</b>	
	4.07T 6 CIL.	01/99	12/06	<b>NKBO0773</b>	
	4.07TCA 4 CIL.	01/99	12/06	<b>NKBO0773</b>	
	4.07TCA 6 CIL.	01/99	12/06	<b>NKBO0773</b>	
	6.07T 4 CIL.	01/99	12/06	<b>NKBO0773</b>	
	6.07T 6 CIL.	01/99	12/06	<b>NKBO0773</b>	
	6.07TCA 4 CIL.	01/99	12/06	<b>NKBO0773</b>	
	6.07TCA 6 CIL.	01/99	12/06	<b>NKBO0773</b>	
A 8	MWM 4.10	01/50	12/11	<b>NKBO0771</b>	Engrenagem 15°
	MWM 4.10T	01/50	12/11	<b>NKBO0771</b>	Engrenagem 15°
	MWM 4.10TCA	01/50	12/11	<b>NKBO0771</b>	Engrenagem 15°
	MWM 6.10	01/50	12/11	<b>NKBO0771</b>	Engrenagem 15°
	MWM 6.10T	01/50	12/11	<b>NKBO0771</b>	Engrenagem 15°
	MWM 6.10TCA	01/50	12/11	<b>NKBO0771</b>	Engrenagem 15°
V5	4.07T 4 CIL.	01/99	12/06	<b>NKBO0773</b>	
	4.07T 6 CIL.	01/99	12/06	<b>NKBO0773</b>	
	4.07TCA 4 CIL.	01/99	12/06	<b>NKBO0773</b>	
	4.07TCA 6 CIL.	01/99	12/06	<b>NKBO0773</b>	
	6.07T 4 CIL.	01/99	12/06	<b>NKBO0773</b>	
	6.07T 6 CIL.	01/99	12/06	<b>NKBO0773</b>	
	6.07TCA 4 CIL.	01/99	12/06	<b>NKBO0773</b>	
	6.07TCA 6 CIL.	01/99	12/06	<b>NKBO0773</b>	
V6	4.07T 4 CIL.	01/99	12/06	<b>NKBO0773</b>	
	4.07T 6 CIL.	01/99	12/06	<b>NKBO0773</b>	
	4.07TCA 4 CIL.	01/99	12/06	<b>NKBO0773</b>	
	4.07TCA 6 CIL.	01/99	12/06	<b>NKBO0773</b>	
	6.07T 4 CIL.	01/99	12/06	<b>NKBO0773</b>	
	6.07T 6 CIL.	01/99	12/06	<b>NKBO0773</b>	
	6.07TCA 4 CIL.	01/99	12/06	<b>NKBO0773</b>	
	6.07TCA 6 CIL.	01/99	12/06	<b>NKBO0773</b>	

**VOLKSWAGEN - MA**

11-130	MWM D229 6 Cil Diesel	01/83	12/92	<b>NKBO0600</b>	Canavieiro / Canavieiro / Canavieiro
11-140	MWM D229 6 Cil Diesel	01/92	12/97	<b>NKBO0600</b>	
12-140	MWM D229 6 Cil Diesel	01/83	12/92	<b>NKBO0600</b>	Canavieiro / Canavieiro / Canavieiro
	MWM D229 6 Cil Diesel	01/92	12/97	<b>NKBO0600</b>	
12-170	5.9 Diesel	01/97	12/00	<b>NKBO0789</b>	Altura do rotor 16,80 mm
13-130	MWM D229 6 Cil Diesel	01/83	12/92	<b>NKBO0600</b>	Canavieiro / Canavieiro / Canavieiro
13-150 Worker	MWM 4.10TCA	01/00	09/06	<b>NKBO0771</b>	Engrenagem 15°
13-170	3.9L 4 Cil Diesel	01/03	12/12	<b>NKBO0250</b>	Altura do rotor 13,64mm
	5.9 Diesel			<b>NKBO0789</b>	Altura do rotor 16,80 mm
13-180	3.9L 4 Cil Diesel	01/03	12/12	<b>NKBO0250</b>	Altura do rotor 13,64mm
13-190	5.9 Diesel	01/01	12/06	<b>NKBO0789</b>	Altura do rotor 16,80 mm

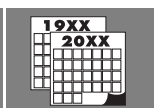
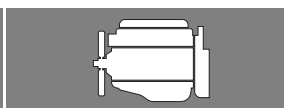

**Caminhões & Ônibus / Camiones y Autobuses / Heavy Trucks & Buses**

**VOLKSWAGEN - MA**

13-190 Worker	MWM 4.10TCA	01/00	09/06	<b>NKBO0771</b>	Engrenagem 15°
14-140	MWM D229 6 Cil Diesel	01/86	12/92	<b>NKBO0600</b>	Canavieiro / Canavieiro / Canavieiro
14-170	5.9 Diesel	01/97	12/00	<b>NKBO0789</b>	Altura do rotor 16,80 mm
14-210	Cummins 6CT 8.3 Diesel	01/80	12/90	<b>NKBO0788</b>	Altura do rotor 21,48mm
	Cummins 6CTA 8.3 Diesel	01/80	12/90	<b>NKBO0788</b>	Altura do rotor 21,48mm
	Cummins 6CTAA 8.3 Dese	01/80	12/90	<b>NKBO0788</b>	Altura do rotor 21,48mm
14-220	Cummins 6CT 8.3 Diesel	01/80	12/90	<b>NKBO0788</b>	Altura do rotor 21,48mm
	Cummins 6CTA 8.3 Diesel	01/80	12/90	<b>NKBO0788</b>	Altura do rotor 21,48mm
	Cummins 6CTAA 8.3 Dese	01/80	12/90	<b>NKBO0788</b>	Altura do rotor 21,48mm
15-160	MWM D229 6 Cil Diesel	01/83	12/92	<b>NKBO0600</b>	Canavieiro / Canavieiro / Canavieiro
15-170	3.9L 4 Cil Diesel	01/03	12/12	<b>NKBO0250</b>	Altura do rotor 13,64mm
	5.9 Diesel	01/00	01/01	<b>NKBO0789</b>	Altura do rotor 16,80 mm
15-180	3.9L 4 Cil Diesel	01/03	12/12	<b>NKBO0250</b>	Altura do rotor 13,64mm
15-180 Worker	MWM 6.10TCA	01/06	12/11	<b>NKBO0771</b>	Engrenagem 15°
15-190	5.9 Diesel	01/01	12/07	<b>NKBO0789</b>	Altura do rotor 16,80 mm
	5.9L 4 Cil Diesel	01/03	12/12	<b>NKBO0255</b>	Altura do rotor 16,80mm
16-170	5.9 Diesel			<b>NKBO0789</b>	Altura do rotor 16,80 mm
	Cummins 6CT 8.3 Diesel	01/76	12/86	<b>NKBO0788</b>	Altura do rotor 21,48mm
	Cummins 6CTA 8.3 Diesel	01/76	12/86	<b>NKBO0788</b>	Altura do rotor 21,48mm
	Cummins 6CTAA 8.3 Dese	01/76	12/86	<b>NKBO0788</b>	Altura do rotor 21,48mm
16-200	5.9 Diesel			<b>NKBO0789</b>	Altura do rotor 16,80 mm
16-210	Cummins 6CT 8.3 Diesel	01/80	12/90	<b>NKBO0788</b>	Altura do rotor 21,48mm
	Cummins 6CTA 8.3 Diesel	01/80	12/90	<b>NKBO0788</b>	Altura do rotor 21,48mm
	Cummins 6CTAA 8.3 Dese	01/80	12/90	<b>NKBO0788</b>	Altura do rotor 21,48mm
16-220	Cummins 6CT 8.3 Diesel	01/80	12/90	<b>NKBO0788</b>	Altura do rotor 21,48mm
	Cummins 6CTA 8.3 Diesel	01/80	12/90	<b>NKBO0788</b>	Altura do rotor 21,48mm
	Cummins 6CTAA 8.3 Dese	01/80	12/90	<b>NKBO0788</b>	Altura do rotor 21,48mm
16-300	Cummins 6CT 8.3 Diesel	01/96	12/00	<b>NKBO0788</b>	Altura do rotor 21,48mm
	Cummins 6CTA 8.3 Diesel	01/96	12/00	<b>NKBO0788</b>	Altura do rotor 21,48mm
	Cummins 6CTAA 8.3 Dese	01/96	12/00	<b>NKBO0788</b>	Altura do rotor 21,48mm
17-180	MWM 4.10	01/50	12/11	<b>NKBO0771</b>	Engrenagem 15°
	MWM 4.10T	01/50	12/11	<b>NKBO0771</b>	Engrenagem 15°
	MWM 4.10TCA	01/50	12/11	<b>NKBO0771</b>	Engrenagem 15°
	MWM 6.10	01/50	12/11	<b>NKBO0771</b>	Engrenagem 15°
	MWM 6.10T	01/50	12/11	<b>NKBO0771</b>	Engrenagem 15°
	MWM 6.10TCA	01/50	12/11	<b>NKBO0771</b>	Engrenagem 15°
17-210	5.9 Diesel	01/00	12/07	<b>NKBO0789</b>	Altura do rotor 16,80 mm
	MWM 6.10TCA	01/00	12/08	<b>NKBO0771</b>	Engrenagem 15°
	MWM 6.10TCA	01/00	12/07	<b>NKBO0771</b>	Engrenagem 15°
17-220	Cummins 6CT 8.3 Diesel	01/00	12/06	<b>NKBO0788</b>	Altura do rotor 21,48mm
	Cummins 6CTA 8.3 Diesel	01/00	12/06	<b>NKBO0788</b>	Altura do rotor 21,48mm
	Cummins 6CTAA 8.3 Dese	01/00	12/06	<b>NKBO0788</b>	Altura do rotor 21,48mm



**Caminhões & Ônibus / Camiones y Autobuses / Heavy Trucks & Buses**

**VOLKSWAGEN - MA**

17-250	5.9L 4 Cil Diesel	01/03	12/12	<b>NKBO0255</b>	Altura do rotor 16,80mm
17-300	Cummins 6CT 8.3 Diesel	01/00	12/02	<b>NKBO0788</b>	Altura do rotor 21,48mm
	Cummins 6CTA 8.3 Diesel	01/00	12/02	<b>NKBO0788</b>	Altura do rotor 21,48mm
	Cummins 6CTAA 8.3 Dese	01/00	12/02	<b>NKBO0788</b>	Altura do rotor 21,48mm
17-300 Worker	MWM 6.10TCA	01/06	12/10	<b>NKBO0771</b>	Engrenagem 15°
17-310	Cummins 6CT 8.3 Diesel	01/02	12/06	<b>NKBO0788</b>	Altura do rotor 21,48mm
	Cummins 6CTA 8.3 Diesel	01/02	12/06	<b>NKBO0788</b>	Altura do rotor 21,48mm
	Cummins 6CTAA 8.3 Dese	01/02	12/06	<b>NKBO0788</b>	Altura do rotor 21,48mm
18-300	Cummins 6CT 8.3 Diesel	01/02	12/06	<b>NKBO0788</b>	Altura do rotor 21,48mm
	Cummins 6CTA 8.3 Diesel	01/02	12/06	<b>NKBO0788</b>	Altura do rotor 21,48mm
	Cummins 6CTAA 8.3 Dese	01/02	12/06	<b>NKBO0788</b>	Altura do rotor 21,48mm
18-350	Cummins 6CT 8.3 Diesel	01/02	12/06	<b>NKBO0788</b>	Altura do rotor 21,48mm
	Cummins 6CTA 8.3 Diesel	01/02	12/06	<b>NKBO0788</b>	Altura do rotor 21,48mm
	Cummins 6CTAA 8.3 Dese	01/02	12/06	<b>NKBO0788</b>	Altura do rotor 21,48mm
19-320	5.9L 4 Cil Diesel	01/03	12/12	<b>NKBO0255</b>	Altura do rotor 16,80mm
22-140	MWM D229 6 Cil Diesel	01/83	12/92	<b>NKBO0600</b>	Canavieiro / Canavieiro / Canavieiro
23-210	5.9 Diesel	01/02	12/06	<b>NKBO0789</b>	Altura do rotor 16,80 mm
23-210 Worker	MWM 6.10TCA	01/02	12/06	<b>NKBO0771</b>	Engrenagem 15°
23-250	5.9L 4 Cil Diesel	01/03	12/12	<b>NKBO0255</b>	Altura do rotor 16,80mm
23-310	Cummins 6CT 8.3 Diesel	01/02	12/06	<b>NKBO0788</b>	Altura do rotor 21,48mm
	Cummins 6CTA 8.3 Diesel	01/02	12/06	<b>NKBO0788</b>	Altura do rotor 21,48mm
	Cummins 6CTAA 8.3 Dese	01/02	12/06	<b>NKBO0788</b>	Altura do rotor 21,48mm
24-220	Cummins 6CT 8.3 Diesel	01/80	12/90	<b>NKBO0788</b>	Altura do rotor 21,48mm
	Cummins 6CTA 8.3 Diesel	01/80	12/90	<b>NKBO0788</b>	Altura do rotor 21,48mm
	Cummins 6CTAA 8.3 Dese	01/80	12/90	<b>NKBO0788</b>	Altura do rotor 21,48mm
24-250	5.9L 4 Cil Diesel	01/03	12/12	<b>NKBO0255</b>	Altura do rotor 16,80mm
	Cummins 6CT 8.3 Diesel	01/80	12/90	<b>NKBO0788</b>	Altura do rotor 21,48mm
	Cummins 6CTA 8.3 Diesel	01/80	12/90	<b>NKBO0788</b>	Altura do rotor 21,48mm
	Cummins 6CTAA 8.3 Dese	01/80	12/90	<b>NKBO0788</b>	Altura do rotor 21,48mm
26-220	Cummins 6CT 8.3 Diesel	01/01	12/06	<b>NKBO0788</b>	Altura do rotor 21,48mm
	Cummins 6CTA 8.3 Diesel	01/01	12/06	<b>NKBO0788</b>	Altura do rotor 21,48mm
	Cummins 6CTAA 8.3 Dese	01/01	12/06	<b>NKBO0788</b>	Altura do rotor 21,48mm
26-300	Cummins 6CT 8.3 Diesel	01/00	12/06	<b>NKBO0788</b>	Altura do rotor 21,48mm
	Cummins 6CTA 8.3 Diesel	01/00	12/06	<b>NKBO0788</b>	Altura do rotor 21,48mm
	Cummins 6CTAA 8.3 Dese	01/00	12/06	<b>NKBO0788</b>	Altura do rotor 21,48mm
26-310	Cummins 6CT 8.3 Diesel	01/01	12/06	<b>NKBO0788</b>	Altura do rotor 21,48mm
	Cummins 6CTA 8.3 Diesel	01/01	12/06	<b>NKBO0788</b>	Altura do rotor 21,48mm
	Cummins 6CTAA 8.3 Dese	01/01	12/06	<b>NKBO0788</b>	Altura do rotor 21,48mm
3.560	MWM D229 6 Cil Diesel	01/92	12/97	<b>NKBO0600</b>	
35-300	Cummins 6CT 8.3 Diesel	01/80	12/90	<b>NKBO0788</b>	Altura do rotor 21,48mm
	Cummins 6CTA 8.3 Diesel	01/80	12/90	<b>NKBO0788</b>	Altura do rotor 21,48mm

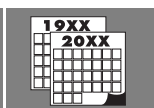
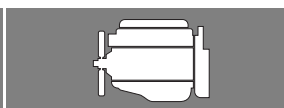

**Caminhões & Ônibus / Camiones y Autobuses / Heavy Trucks & Buses**

**VOLKSWAGEN - MA**

35-300	Cummins 6CTAA 8.3 Dese	01/80	12/90	<b>NKBO0788</b>	Altura do rotor 21,48mm
40-300	Cummins 6CT 8.3 Diesel	01/99	12/02	<b>NKBO0788</b>	Altura do rotor 21,48mm
	Cummins 6CTA 8.3 Diesel	01/99	12/02	<b>NKBO0788</b>	Altura do rotor 21,48mm
	Cummins 6CTAA 8.3 Dese	01/99	12/02	<b>NKBO0788</b>	Altura do rotor 21,48mm
4800	MWM D229 6 Cil Diesel	01/92	12/97	<b>NKBO0600</b>	
5-140	4.07T 4 CIL.	01/00	12/12	<b>NKBO0773</b>	
	4.07T 6 CIL.	01/00	12/12	<b>NKBO0773</b>	
	6.07T 4 CIL.	01/00	12/12	<b>NKBO0773</b>	
	6.07T 6 CIL.	01/00	12/12	<b>NKBO0773</b>	
6-80	Perkins 4236 4 Cil Diesel	01/82	12/93	<b>NKBO0400</b>	
6-90	MWM D229 4 Cil Diesel	01/83	12/93	<b>NKBO0600</b>	
	Perkins 4236 4 Cil Diesel	01/82	12/92	<b>NKBO0400</b>	
7-100	MWM 4.10TCA	01/02	12/07	<b>NKBO0771</b>	Engrenagem 15°
7-110	TD 229 6 Cil Diesel	01/87	12/94	<b>NKBO0772</b>	
7-90	MWM D229 4 Cil Diesel	01/83	12/93	<b>NKBO0600</b>	
	Perkins 4236 4 Cil Diesel	01/82	12/92	<b>NKBO0400</b>	
	TD 229 4 Cil Diesel	01/86	12/94	<b>NKBO0772</b>	
8-120	MWM 4.10TCA	01/05	12/09	<b>NKBO0771</b>	Engrenagem 15°
8-150	4.07TCA 4 CIL.	01/00	12/12	<b>NKBO0773</b>	
	4.07TCA 6 CIL.	01/00	12/12	<b>NKBO0773</b>	
	6.07TCA 4 CIL.	01/00	12/12	<b>NKBO0773</b>	
	6.07TCA 6 CIL.	01/00	12/12	<b>NKBO0773</b>	
	3.9L 4 Cil Diesel	01/03	12/12	<b>NKBO0250</b>	Altura do rotor 13,64mm
	MWM 4.10TCA	01/00	12/09	<b>NKBO0771</b>	Engrenagem 15°
9-150	3.9L 4 Cil Diesel	01/03	12/12	<b>NKBO0250</b>	Altura do rotor 13,64mm
	MWM 4.10TCA	01/00	12/09	<b>NKBO0771</b>	Engrenagem 15°

**VOLVO**

VM 17	MWM 6.10TCA	01/50	12/11	<b>NKBO0771</b>	Engrenagem 15°
VM 23	MWM 6.10TCA	01/50	12/11	<b>NKBO0771</b>	Engrenagem 15°

**NKBO0100**



**NKBO0105**



**NKBO0110**



**NKBO0115**

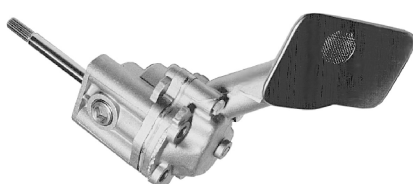

**NKBO0120**

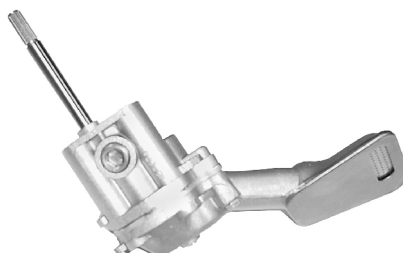

**NKBO0130**

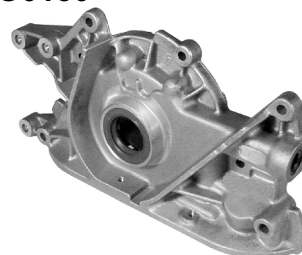

**NKBO0135**

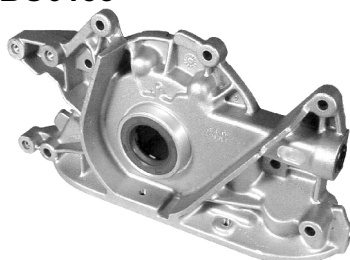

**NKBO0136**

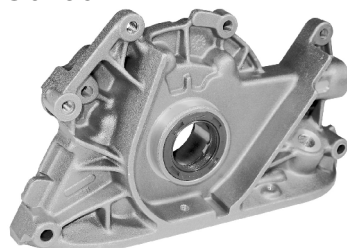

**NKBO0140**

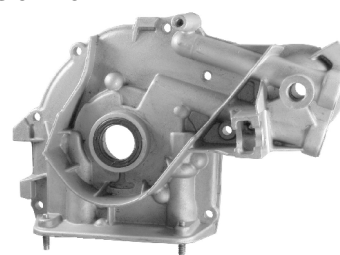

**NKBO0145**



**NKBO0150**



**NKBO0155**

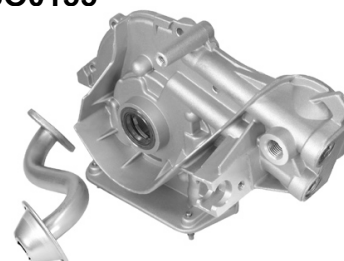

**NKBO0160**



**NKBO0200**

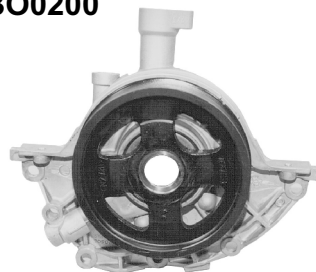

**NKBO0201**



**NKBO0202**



**NKBO0203**

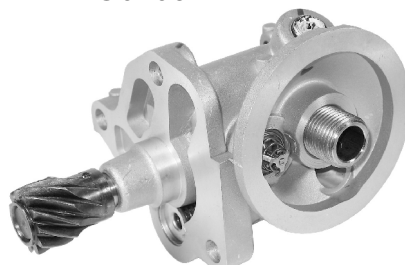

**NKBO0205**

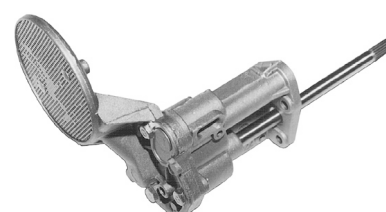

**NKBO0210**

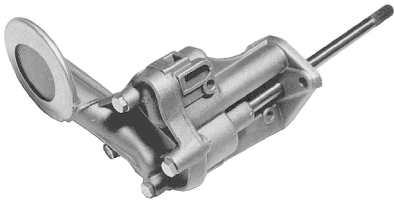

**NKBO0215**

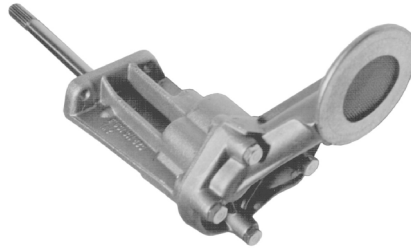

**NKBO0220**



**NKBO0225**



**NKBO229**



**NKBO0230**



**NKBO0235**



**NKBO0245**

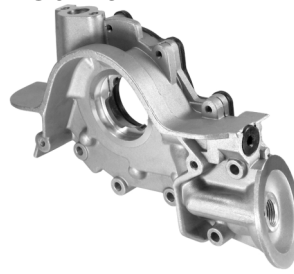

**NKBO0250**



**NKBO0255**



**NKBO0300**

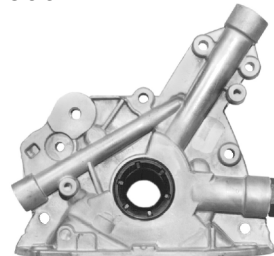

**NKBO0305**

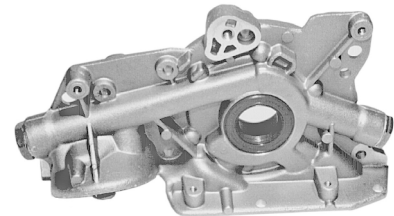

**NKBO0310**

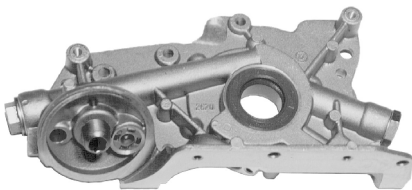

**NKBO0315**

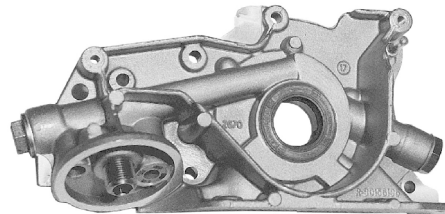

**NKBO0320**

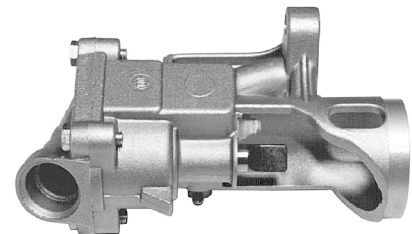

**NKBO0325**



**NKBO0330**

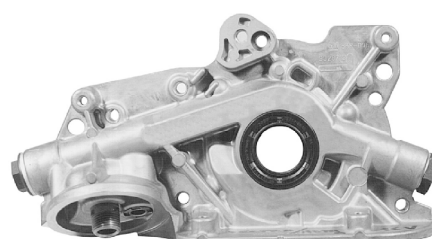

**NKBO0331**





**NKBO0333**



**NKBO0335**



**NKBO0340**

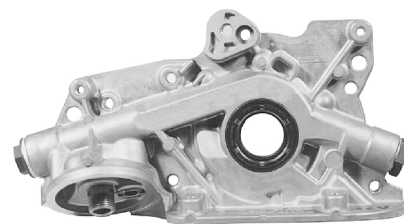

**NKBO0343**



**NKBO0350**



**NKBO0400**

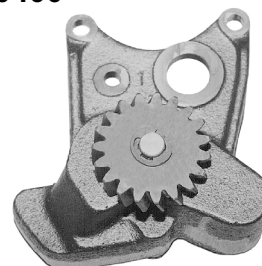

**NKBO0405**

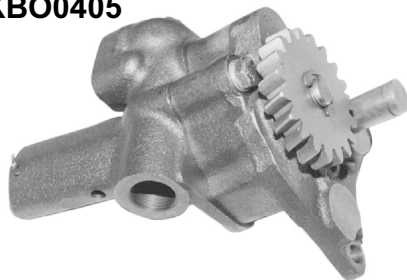

**NKBO0410**



**NKBO0415**



**NKBO0425**

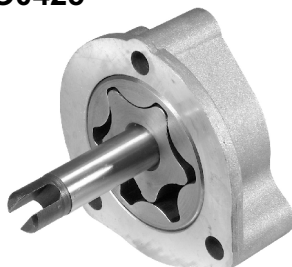

**NKBO0435**



**NKBO0500**

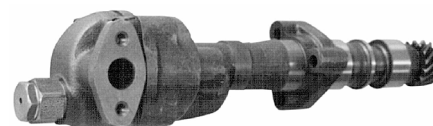

**NKBO0505**

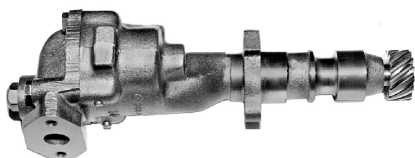

**NKBO0510**

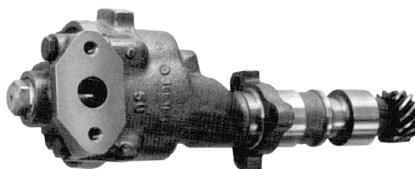

**NKBO0515**



**NKBO0520**

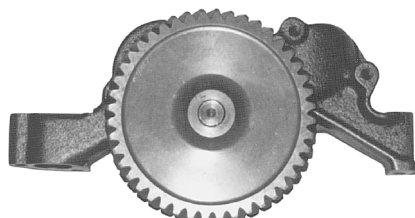

**NKBO0525**

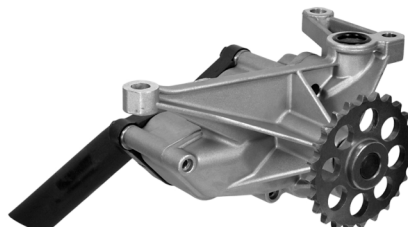

**NKBO0530**

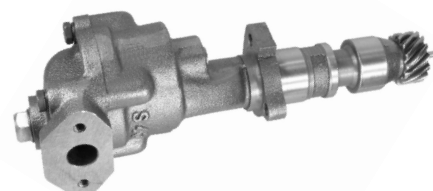

**NKBO0535**



**NKBO0540**

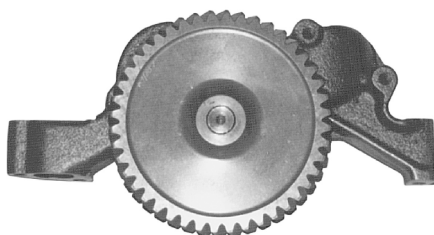

**NKBO0550**

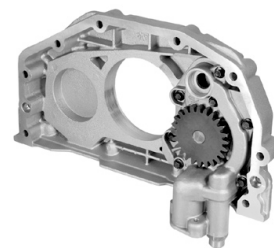

**NKBO0600**

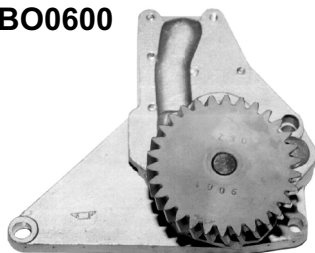

**NKBO0700**



**NKBO0704**



**NKBO0705**

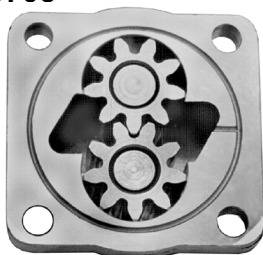

**NKBO0710**



**NKBO0715**

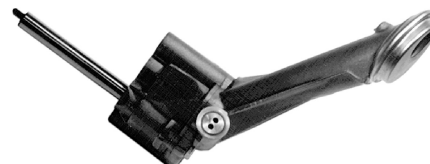

**NKBO0720**

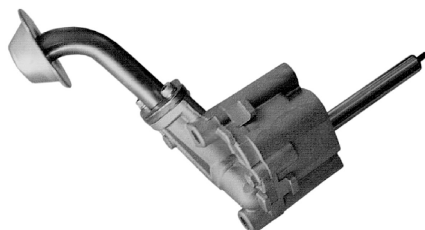

**NKBO0725**



**NKBO0730**

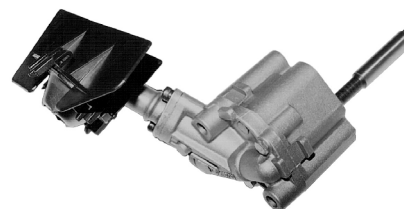

**NKBO0735**

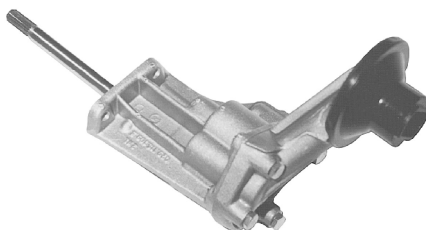

**NKBO0740**



**NKBO0745**

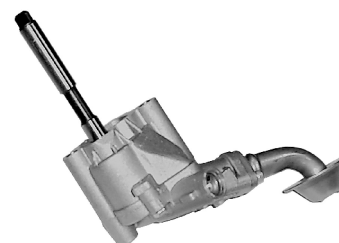

**NKBO0755**

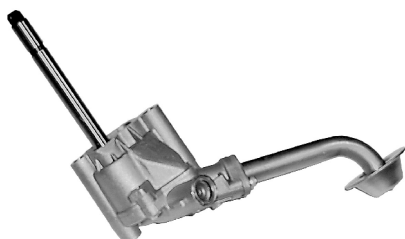

**NKBO0760**

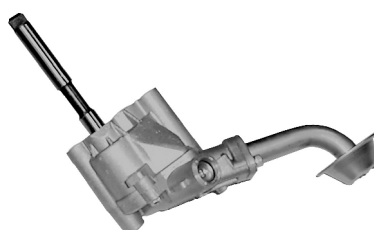

**NKBO0765**

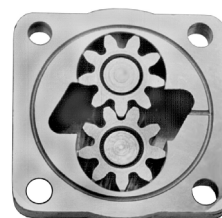

NKBO0770

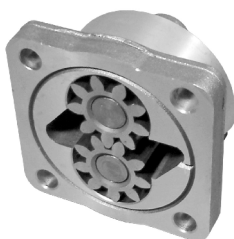

NKBO0771



NKBO0772



NKBO0773

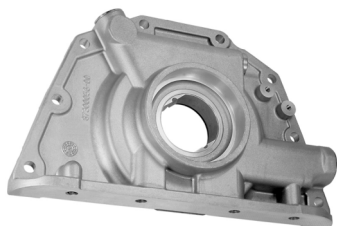

NKBO0775

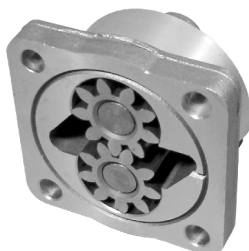

NKBO0776



NKBO0785



NKBO0787



NKBO0788



NKBO0789



NKBO0790

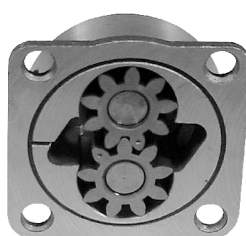

NKBO0792

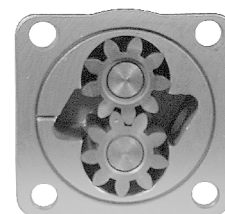

NKBO0793

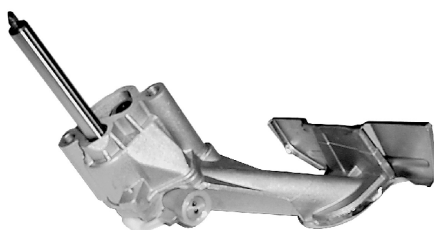

NKBO0794

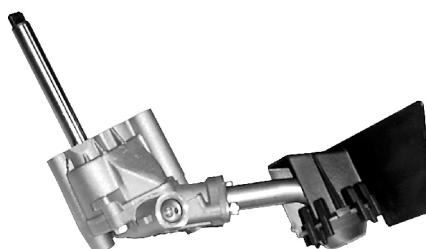

NKBO0795

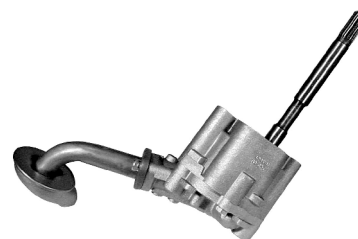

NKBO0796

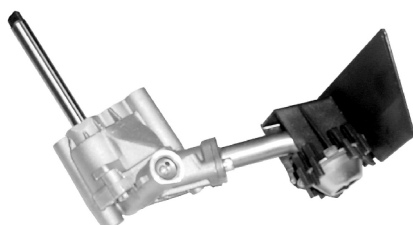

NKBO0797

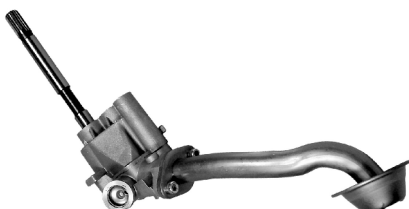

NKBO0798

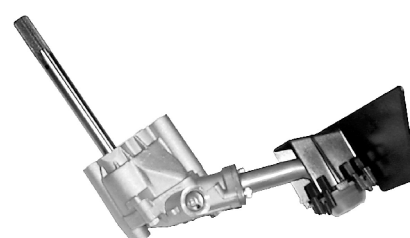

NKBO0799

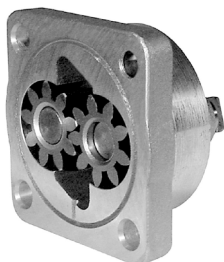

NKBO0800

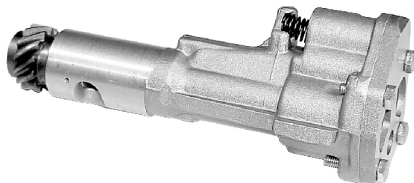

NKBO0801

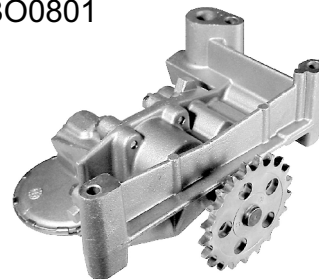

NKBO0802

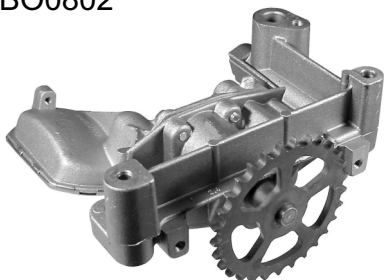

NKBO0803

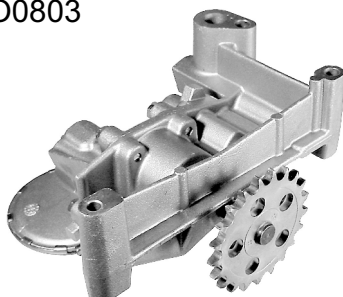

NKBO0804

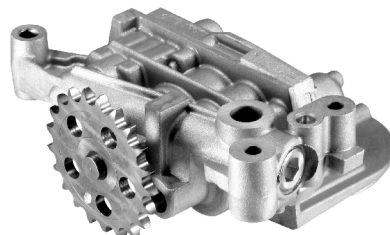

NKBO0805

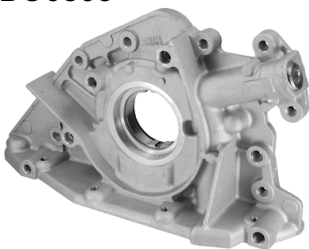

NKBO0900

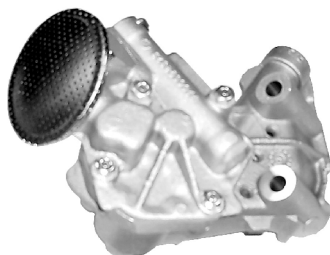

NKBO0902

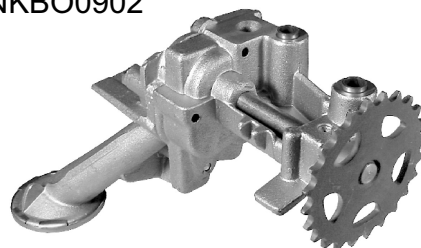

NKBO0903



NKBO0904

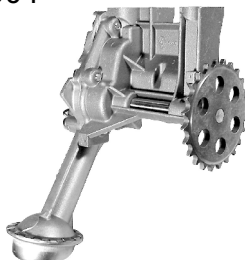

NKBO0905

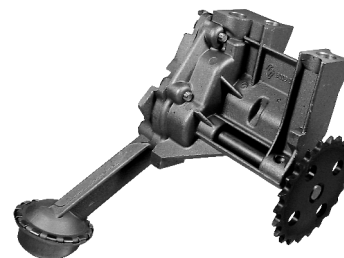

NKBO0906

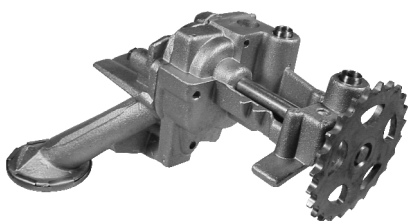

NKBO0908



NKBO0909



NKBO10000



NKBO10001

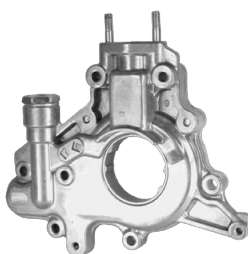

NKBO11000



**Tabela de Equivalência / Bomba de Óleo AM**

**Cruce de Referencias / Bomba de Aceite AM**

**Cross Reference List / Oil Pumps AM**



ANROI		ANROI		SCHADEK	
# ANROI	# NAKATA	# ANROI	# NAKATA	# SCHADEK	# NAKATA
AR1000	NKBO0715	AT7070	NKBO0130	10133	NKBO0788
AR1065	NKBO0710	AT7075	NKBO0135	10136	NKBO0773
AR1100	NKBO0720	AT7080	NKBO0145	10138	NKBO0203
AR3020	NKBO0205	AT7085	NKBO0140	10143	NKBO0900
AR3060	NKBO0229	AT7087	NKBO0155	10146	NKBO0120
AR3070	NKBO0230	AT8010	NKBO0788	10149	NKBO0340
AR4030	NKBO0405	AT8020	NKBO0235	10150	NKBO0135
AR4040	NKBO0400	AT8021	NKBO0789	10154	NKBO0755*
AR5010	NKBO0500	AT8520	NKBO10000	10167	NKBO0235
AR5020	NKBO0530	AT8521	NKBO10001	10168	NKBO0700
AR5030	NKBO0515	AT9021	NKBO0415	10169	NKBO0789
AR6010	NKBO0600	AT9022	NKBO0425	10172	NKBO0415
AR7010	NKBO0100			10173	NKBO0330
AR7030	NKBO0105			10175	NKBO0797
AT1035	NKBO0705			10179	NKBO0771
AT1200	NKBO0725			10182	NKBO0787
AT1250	NKBO0735			10188	NKBO0145
AT1251	NKBO0735			10189	NKBO0140
AT1255	NKBO0745			10192	NKBO0904
AT1265	NKBO0776			10193	NKBO0903
AT1305	NKBO0704			10194	NKBO0902
AT1310	NKBO0700			10195	NKBO0740
AT2025	NKBO0325			10197	NKBO0704
AT2035	NKBO0320			10199	NKBO0343
AT2045	NKBO0310			10208	NKBO0331
AT2055	NKBO0310			10210	NKBO0202
AT2060	NKBO0305			10210A	NKBO0200
AT2066	NKBO0340			10215	NKBO0525
AT2070	NKBO0300			10216	NKBO0540
AT2071	NKBO0335			10217	NKBO0410
AT2072	NKBO0333			10218	NKBO0802
AT2110	NKBO0797			10219	NKBO0801
AT3035	NKBO0210			10227	NKBO0550
AT3036	NKBO0215			10231	NKBO0225
AT3090	NKBO0203			10234	NKBO0906
AT3095	NKBO0202			10235	NKBO0905
AT3096	NKBO0200			10242	NKBO0333
AT3096	NKBO0225			10246	NKBO0250
AT3098	NKBO0245			10247	NKBO0255
AT3130	NKBO0900			10250	NKBO0776
AT3151	NKBO0903			10254	NKBO0335
AT3154	NKBO0905			10255	NKBO0150
AT3160	NKBO0902			10262	NKBO0350
AT3500	NKBO0802			10267	NKBO0425
AT3501	NKBO0801			10268	NKBO0435
AT5050	NKBO0505			10269	NKBO0804
AT5060	NKBO0510			10272	NKBO0909
AT5060	NKBO0535			10273	NKBO0908
AT5080	NKBO0520			10276	NKBO0805
AT6030	NKBO0772			10278	NKBO0155
AT6040	NKBO0771			10280	NKBO11000
AT6050	NKBO0773			10285	NKBO0803
AT7035	NKBO0110			10296	NKBO0160
AT7050	NKBO0115				
AT7060	NKBO0120				

**SCHADEK**

# SCHADEK # NAKATA

# Tabela de Equivalência / Bomba de Óleo OE

Cruce de Referências / Bomba de Aceite OE

Cross Reference List / Oil Pumps OE

# NAKATA®

FIAT		GENERAL MOTORS		RENAULT	
# FIAT	# NAKATA	# GENERAL MOTORS	# NAKATA	# RENAULT	# NAKATA
4391376	NKBO0115	90541505	NKBO0300	8200227686	NKBO0905
4423006	NKBO0100	90541506	NKBO0305	8200279956	NKBO0906
46467340	NKBO0120	90570919	NKBO0300	8200591428	NKBO0909
50004346	NKBO0135	90570921	NKBO0305	8200698014	NKBO0908
55205437	NKBO0145	90570925	NKBO0340		
55205942	NKBO0140	90570980	NKBO0330		
55205943	NKBO0150	9129092	NKBO0330		
55223582	NKBO0160	93244703	NKBO0300		
7085035	NKBO0335	93287137	NKBO0330		
7533576	NKBO0110	93293030	NKBO0300		
7555208	NKBO0105	93294869	NKBO0331		
7717404	NKBO0136	93330219	NKBO0333		
7758296	NKBO0130	93342353	NKBO0773		
93294869	NKBO0331	93377141	NKBO0335		
93330219	NKBO0333	94610563	NKBO0320		
		94657310	NKBO0310		
		MSB73001	NKBO0773		
FORD		MAXION		VOLKSWAGEN	
# FORD	# NAKATA	# MAXION	# NAKATA	# VOLKSWAGEN	# NAKATA
1S7Z6600AA	NKBO0225	41314054	NKBO0400	026115105A	NKBO0725
291151055	NKBO0215	41314087	NKBO0405	027115105A	NKBO0798*
2SG6600AC	NKBO0201	41314182	NKBO0400	027115105B	NKBO0760*
59909	NKBO0205	70998060	NKBO0405	027115105C	NKBO0798*
77BM6600AB	NKBO0229	709990419	NKBO0405	030115105P	NKBO0700
77BM6600BB	NKBO0203			032115105G	NKBO0704
85NU6600A	NKBO0210			036115105B	NKBO0700
928M6600A2B1	NKBO0245			049115105A	NKBO0793*
BF0T6600AA	NKBO0773			049115105H	NKBO0720
BF5T6600AA	NKBO0235			051115105A	NKBO0795*
BF5T6A019AA	NKBO0343			053115105C	NKBO0740
BF5X6600BA	NKBO0789			055115105D	NKBO0796*
BG1X6600AA	NKBO0788			055155105D	NKBO0796*
BG3T6600BA	NKBO0773			056115105A	NKBO0715
BG3X6600AA	NKBO0788			058115105C	NKBO0797
BG5X6600AA	NKBO0250			068115105AG	NKBO0798*
BG5X6600BA	NKBO0255			068115105BN	NKBO0798*
D4FZ6600A	NKBO0220			06A115105B	NKBO0787
E1NN6600DD	NKBO0230			111115107AK	NKBO0790*
XS6E6600AD	NKBO0200			111115107BK	NKBO0792*
XS6E6600AG	NKBO0202			26115105	NKBO0720
GENERAL MOTORS		MWM		PEUGEOT	
# GENERAL MOTORS	# NAKATA	# MWM	# NAKATA	# PEUGEOT	# NAKATA
3832449	NKBO0325	632507300076	NKBO0600	100137	NKBO0800
646023	NKBO0315	940707300016	NKBO0773	100169	NKBO0803
646026	NKBO0315	940707300056	NKBO0773	100177	NKBO0802
646041	NKBO0300	960707300026	NKBO0773	100187	NKBO0801
646042	NKBO0305	960787300026	NKBO0773	1001C7	NKBO0805
646067	NKBO0330	9610873000	NKBO0771	1001C9	NKBO0804
70832261	NKBO0333			1001G0	NKBO0805
70992867	NKBO0343				
90411568	NKBO0305				
90412744	NKBO0300				
90442362	NKBO0305				
90499157	NKBO0340				
		RENAULT			
# GENERAL MOTORS	# NAKATA	# RENAULT	# NAKATA	# RENAULT	# NAKATA
		7701465119	NKBO0900	41115105	NKBO0776
		7701465761	NKBO0900	41314054	NKBO0400
		7701585084	NKBO0900	531151051	NKBO0725
		7701693575	NKBO0904	6811510512	NKBO0755*
		7701693576	NKBO0903	TF3115105	NKBO0788
		7701693577	NKBO0902		
		770692922	NKBO0900		

Código/ Codigo/ PIN	Página/ Pagina/ Page
------------------------	----------------------------

**Veiculos de Passeio & Pick-ups / Vehiculos de Paseo y Camionetas / Passenger Cars & Light Pick-ups**

NKBO0100	Pag 66, 67
NKBO0105	Pag 66, 67, 68
NKBO0110	Pag 66, 67, 68
NKBO0115	Pag 66, 67, 68
NKBO0120	Pag 66, 67, 68
NKBO0130	Pag 68
NKBO0135	Pag 68
NKBO0136	Pag 68
NKBO0140	Pag 66, 67, 68, 69
NKBO0145	Pag 67, 68, 69
NKBO0150	Pag 66, 67, 68
NKBO0155	Pag 66, 67, 68
NKBO0160	Pag 66, 67, 68
NKBO0200	Pag 69, 70
NKBO0201	Pag 69
NKBO0202	Pag 69, 70
NKBO0203	Pag 69, 70
NKBO0205	Pag 69
NKBO0210	Pag 69, 70
NKBO0215	Pag 69, 70
NKBO0220	Pag 70
NKBO0225	Pag 69, 70
NKBO0245	Pag 69
NKBO0300	Pag 70, 71, 72, 73
NKBO0305	Pag 70, 71, 72, 73
NKBO0310	Pag 72, 73
NKBO0315	Pag 72
NKBO0320	Pag 71, 72
NKBO0325	Pag 70, 71, 72, 73
NKBO0330	Pag 70, 73
NKBO0331	Pag 71, 72
NKBO0333	Pag 66, 68, 72
NKBO0335	Pag 66, 67, 68, 71, 72
NKBO0340	Pag 70, 71, 72, 73, 74
NKBO0343	Pag 69, 70, 71, 73, 74
NKBO0345	Pag 72, 73
NKBO0350	Pag 71, 73, 74
NKBO0525	Pag 74
NKBO0700	Pag 66, 76, 77, 78, 79, 80

Código/ Codigo/ PIN	Página/ Pagina/ Page
------------------------	----------------------------

**Veiculos de Passeio & Pick-ups / Vehiculos de Paseo y Camionetas / Passenger Cars & Light Pick-ups**

NKBO0704	Pag 76, 78
NKBO0705	Pag 76, 77, 78
NKBO0710	Pag 76, 77, 78
NKBO0715	Pag 77, 78, 80
NKBO0720	Pag 77, 78, 79, 80
NKBO0725	Pag 66, 69, 70, 77, 78, 79, 80, 81
NKBO0730	Pag 69, 75, 76, 78, 79, 80
NKBO0735	Pag 76, 77, 78, 79, 80
NKBO0740	Pag 77, 78
NKBO0745	Pag 76, 78, 79
NKBO0760*	Pag 75, 77, 78, 80
NKBO0765*	Pag 80
NKBO0770*	Pag 80
NKBO0775*	Pag 80
NKBO0776	Pag 77, 78, 79
NKBO0785*	Pag 66, 78, 79, 80
NKBO0787	Pag 66, 75, 76, 77, 78, 79, 80
NKBO0790*	Pag 80
NKBO0792*	Pag 80
NKBO0793*	Pag 77, 79
NKBO0794*	Pag 77, 79, 80
NKBO0795*	Pag 75, 77, 78, 80
NKBO0796*	Pag 77, 79, 80
NKBO0797	Pag 78, 80
NKBO0798*	Pag 77, 79
NKBO0800	Pag 74
NKBO0801	Pag 66, 74
NKBO0802	Pag 66, 74
NKBO0803	Pag 74
NKBO0804	Pag 66, 74
NKBO0805	Pag 66, 74
NKBO0900	Pag 74, 75
NKBO0902	Pag 75
NKBO0903	Pag 74, 75
NKBO0904	Pag 74, 75
NKBO0905	Pag 74, 75
NKBO0906	Pag 75
NKBO0908	Pag 75
NKBO0909	Pag 74, 75

Código/ Código/ PIN	Página/ Página/ Page
------------------------	----------------------------

**Veículos de Passeio & Pick-ups / Vehículos de Paseo y Camionetas / Passenger Cars & Light Pick-ups**

NKBO10000 Pag 74

NKBO10001 Pag 74

NKBO11000 Pag 75

**Motor / Motor / Engine**

NKBO0425 Pag 81

NKBO0435 Pag 81

**Máquinas Agrícolas & Fora de Estrada / Vehículos Fuera de Carretera / Off Highway**

NKBO0229 Pag 82

NKBO0405 Pag 81, 82, 83

**Caminhões & Ônibus / Camiones y Autobuses / Heavy Trucks & Buses**

NKBO0230 Pag 82, 86

NKBO0235 Pag 69, 85, 86

NKBO0250 Pag 84, 85, 91, 92, 94

NKBO0255 Pag 85, 92, 93

NKBO0400 Pag 70, 72, 73, 81, 82, 83, 84, 86, 94

NKBO0410 Pag 90

NKBO0415 Pag 90

NKBO0500 Pag 75, 81, 82, 86, 87, 88, 89, 90

NKBO0505 Pag 81, 83, 86, 87, 88, 89, 90

NKBO0510 Pag 81, 83, 86, 87, 88, 89, 90

NKBO0515 Pag 87, 88

NKBO0520 Pag 81, 87, 88, 89, 90

NKBO0530 Pag 89, 90

NKBO0535 Pag 89, 90

NKBO0540 Pag 88, 89

NKBO0550 Pag 87, 88, 89

NKBO0600 Pag 66, 81, 82, 83, 84, 85, 86, 90, 91, 92, 93, 94

NKBO0771 Pag 83, 84, 85, 86, 91, 92, 93, 94

NKBO0772 Pag 94

NKBO0773 Pag 71, 72, 73, 74, 83, 86, 91, 94

NKBO0788 Pag 84, 85, 92, 93, 94

NKBO0789 Pag 84, 85, 86, 91, 92, 93



A black and white photograph showing several fuel pumps of different designs and sizes arranged on a highly reflective, curved surface. In the foreground, several gaskets of various shapes are scattered. The background is a plain, light-colored wall. The pumps are metallic and have various ports and fittings. The lighting creates sharp reflections on the surface.

# BOMBAS DE COMBUSTÍVEL

Bombas de Combustible / Fuel Pumps

***Veículos: Leve e Pesado***  
***Vehículos: Liviano y Pesado***  
***Vehicles: Light and Heavy Duty***

**Página/  
Pagina/  
Page****Página/  
Pagina/  
Page****Veiculos de Passeio & Pick-ups / Vehiculos de Paseo y Camionetas /  
Passenger Cars & Light Pick-ups**

FIAT 109

FORD 109

GENERAL MOTORS 110

LADA 111

VOLKSWAGEN 111

**Motor / Motor / Engine**

M.W.M. 112

MAXION 112

PERKINS 112

**Caminhões & Ônibus / Camiones y Autobuses / Heavy Trucks & Buses**

AGRALE 113

FORD 113

Neste catálogo você encontrará todas as aplicações da linha de **Bombas de Combustível NAKATA**. O catálogo está dividido em três tabelas e um índice por código.

**Aplicação por montadora e veículo:** localizada a partir da página 109 apresenta todas as aplicações de Bombas de Combustível, divididas de acordo com a montadora do veículo.

**Tabela de equivalência:** localizada a partir da página 114, mostra os códigos dos produtos que devem ser aplicados no lugar de modelos fabricados por outras marcas.

**Tabela de ilustrações:** Localizada na página 115, facilita a identificação do produto desejado.

En este catálogo usted encontrará todas las aplicaciones de la línea de **Bomba de Combustible NAKATA**. El catálogo está dividido en tres tablas y un índice por código.

**Aplicación por marca y modelo:** esta tabla presenta todas las aplicaciones de homocinéticas, dividida de acuerdo con la ensambladora del vehículo.

**Cruce de referencias:** esta tabla indica los códigos de intercambio con otras marcas de la competencia.

**Tabla de ilustraciones:** esta tabla presenta el dibujo de cada producto para mejor identificación.

In this catalog, you will find all information about NAKATA Fuel pumps. This catalog is divided in three charts and one index code.

**Application by maker and model:** this section presents all applications about Fuel pumps, divided according to the car maker.

**Cross reference list:** this section presents all carmaker cross reference part numbers.

**Illustration chart:** this section presents the image of each product.

<b>Aplicação por Montadora e veículo / Bomba de Combustível</b>		<b>Aplicación por marca y modelo / Bomba de Combustible</b>		<b>Application by maker and model / Fuel Pumps</b>		<b>NAKATA®</b>
1	2	3	4	5	6	
<b>Veiculos de Passeio &amp; Pick-ups / Vehiculos de Paseo y Camionetas / Passenger Cars &amp; Light Pick-ups</b>						
<b>FIAT</b>						
147	1.050 4 Cil	●		01/77	12/81	NKBC01300
	1.3 8V 4 Cil	●		01/82	12/85	NKBC01300
Elba	1.3 8V 4 Cil	●		01/82	12/90	NKBC01300
	1.5 Sevel 4 Cil	●		01/89	12/93	NKBC01400
	1.6 8V 4 Cil	●		01/89	12/94	NKBC01500
Fiorino	1.3 8V 4 Cil	●		01/82	12/94	NKBC01300
	1.5 FIASA 4 Cil	●		01/89	12/94	NKBC01300
Panorama	1.3 8V 4 Cil	●		01/82	12/84	NKBC01300
Pick-up LX	1.5 FIASA 4 Cil	●		01/89	12/94	NKBC01300
	1.6 8V 4 Cil	●		01/89	12/94	NKBC01500
Premio	1.3 8V 4 Cil	●		01/82	12/90	NKBC01300
	1.5 Sevel 4 Cil	●		01/89	12/93	NKBC01400
	1.6 8V 4 Cil	●		01/89	12/93	NKBC01500
Spazio	1.3 8V 4 Cil	●		01/82	12/85	NKBC01300
Uno	1.0 8V 4 Cil	●		01/92	12/95	NKBC01300
	1.3 8V 4 Cil	●		01/82	12/94	NKBC01300
	1.5R Sevel 4 Cil	●		01/89	12/93	NKBC01400

A estrutura das tabelas é similar, apresentando as seguintes informações:  
 La estructura de las tablas es similar, presentando las siguientes informaciones:  
 The structure from the tables is similar, presenting the following information:

- ❶ Veículo / Vehículo / Vehicle
- ❷ Motor / Motor / Engine
- ❸ Combustível / Combustible / Fuel  
Ano (Ano Inicial / Ano Final)
- ❹ Año (Año Inicial / Año Final)  
Year (Start Year / End Year)
- ❺ Código Nakata / Código Nakata / Code Nakata
- ❻ Observação / Observación / Remark

Tabela de Equivalência / Bomba de Combustível				<b>NAKATA®</b>			
Cruce de Referencias / Bomba de Combustible							
Cross Reference List / Fuel Pumps							
<b>BROSOL</b>		<b>CARTER</b>		<b>GENERAL MOTORS</b>		<b>VOLKSWAGEN</b>	
BROSOL	Nakata	CARTER	Nakata	GENERAL MOT	Nakata	VOLKSWAGEN	Nakata
214131	NKBC07131	60457	NKBC04900	94642703	NKBC03122	401270258	NKBC07131
218510	NKBC07510	60459	NKBC06100	94644682	NKBC03711	411270251	NKBC07131
218910	NKBC07910	60460	NKBC06200	94658977	NKBC03141	561270252	NKBC07510
243122	NKBC03122	60461	NKBC07910			561270254	NKBC07510
243141	NKBC03141	6732	NKBC02300	<b>MAXION</b>			
245400	NKBC03400	6734	NKBC02200	MAXION	Nakata		
245711	NKBC03711	6783	NKBC03122	2841326	NKBC04400		
251091	NKBC02091	<b>FIAT</b>		2841327	NKBC04400		
251510	NKBC02510	FIAT	Nakata	2841371	NKBC04700		
251700	NKBC02700	7552503	NKBC01400	2841406	NKBC04500		
252200	NKBC02200	7552526	NKBC01400	2641719	NKBC04600		
252300	NKBC02300	7656013	NKBC01500	72013	NKBC04100		
280100	NKBC04100	7662758	NKBC01500	72023	NKBC04500		
280200	NKBC04200	7703714	NKBC01300	72024	NKBC04400		
280400	NKBC04400	7718702	NKBC01300	72025	NKBC04700		
280500	NKBC04500	<b>FORD</b>		72027	NKBC04800		
280600	NKBC04600	FORD	Nakata	72028	NKBC04600		
280700	NKBC04700	10690	NKBC02200	72042	NKBC04200		
280800	NKBC04800	2612702510	NKBC07910	72061	NKBC04800		
280900	NKBC04900	2612702511	NKBC07910	72062	NKBC04600		
270100	NKBC06100	281270252	NKBC02700	72064	NKBC04100		
270200	NKBC06200	561270252	NKBC07510	72068	NKBC04200		
280400	NKBC01400	561270254	NKBC07510	72069	NKBC04500		
281300	NKBC01300	758U9350B	NKBC02300	72070	NKBC04700		
281500	NKBC01500	78TL9350A	NKBC02300	72081	NKBC04900		
<b>CARTER</b>		820U9350A	NKBC02510	72083	NKBC04200		
CARTER	Nakata	820U9350A	NKBC02300	72084	NKBC04500		
60208	NKBC04100	84AU9350D	NKBC02700	72085	NKBC04400		
60211	NKBC02510	84AU9350E	NKBC02700	72086	NKBC04600		
60228	NKBC04200	016900	NKBC02200	72087	NKBC04800		
60249	NKBC04400	BD4T8350A	NKBC02200	<b>MWM</b>			
60250	NKBC04500	D42E9350AC	NKBC02300	MWM	Nakata		
60251	NKBC04600			9052002000040	NKBC06100		
60252	NKBC04700						

Tabela de Ilustrações / Bombas de Combustível					<b>NAKATA®</b>				
Tablas de Ilustraciones / Bombas de Combustible									
Illustrations Chart / Fuel Pumps									
NKBC01300	NKBC01400	NKBC01500	NKBC02091	NKBC02200					
NKBC02300	NKBC02510	NKBC02700	NKBC03122	NKBC03141					
NKBC03400	NKBC03711	NKBC04100	NKBC04200	NKBC04400					
NKBC04500	NKBC04600	NKBC04700	NKBC04800	NKBC04900					

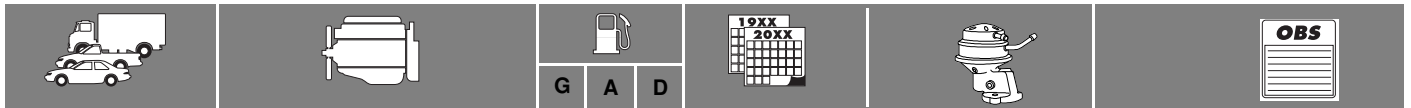

**Veiculos de Passeio & Pick-ups / Vehiculos de Paseo y Camionetas / Passenger Cars & Light Pick-ups**

**FIAT**

147	1.050 4 Cil	●		01/77	12/81	NKBC01300	
	1.3 8V 4 Cil	●		01/82	12/85	NKBC01300	
Elba	1.3 8V 4 Cil	●		01/82	12/90	NKBC01300	
	1.5 Sevel 4 Cil	●		01/89	12/93	NKBC01400	
	1.6 8V 4 Cil	●		01/89	12/94	NKBC01500	
Fiorino	1.3 8V 4 Cil	●		01/82	12/94	NKBC01300	
	1.5 FIASA 4 Cil	●		01/89	12/94	NKBC01300	
Panorama	1.3 8V 4 Cil	●		01/82	12/84	NKBC01300	
Pick-up LX	1.5 FIASA 4 Cil	●		01/89	12/94	NKBC01300	
	1.6 8V 4 Cil	●		01/89	12/94	NKBC01500	
Premio	1.3 8V 4 Cil	●		01/82	12/90	NKBC01300	
	1.5 Sevel 4 Cil	●		01/89	12/93	NKBC01400	
	1.6 8V 4 Cil	●		01/89	12/93	NKBC01500	
Spazio	1.3 8V 4 Cil	●		01/82	12/85	NKBC01300	
Uno	1.0 8V 4 Cil	●		01/92	12/95	NKBC01300	
	1.3 8V 4 Cil	●		01/82	12/94	NKBC01300	
	1.5R Sevel 4 Cil	●		01/89	12/93	NKBC01400	
	1.6R 4 Cil	●		01/89	12/93	NKBC01500	

**FORD**

Aero Willys	3.0 8V 4 Cil	●		01/60	12/76	NKBC02200		
Belina	1.3 8V 4 Cil	●		01/75	12/83	NKBC02510		
	1.4 8V 4 Cil	●		01/75	12/83	NKBC02510		
	1.6 8V 4 Cil	●		01/78	12/83	NKBC02510		
	1.6 CHT 4 Cil	●		01/84	12/91	NKBC02091		
			●		01/84	12/91	NKBC02700	Crash Whorly
	1.8 AP 8V 4 Cil			01/89	12/91	NKBC07510		
Corcel	1.4 8V 4 Cil	●		01/69	12/83	NKBC02510		
	1.6 8V 4 Cil	●		01/78	12/83	NKBC02510		
	1.6 CHT 4 Cil	●		01/84	12/86	NKBC02091		
			●		01/84	12/86	NKBC02700	Crash Whorly
Del Rey	1.6 8V 4 Cil	●		01/81	12/83	NKBC02510		
	1.6 CHT 4 Cil	●		01/84	12/91	NKBC02091		
			●		01/84	12/91	NKBC02700	Crash Whorly
		1.8 AP 8V 4 Cil	●		01/89	12/91	NKBC07510	
Escort	1.0 AE 4 Cil	●		01/93	12/96	NKBC02700		
	1.6 AE 4 Cil	●		01/91	12/96	NKBC02700		
	1.6 CHT 4 Cil	●		01/83	12/91	NKBC02700	Crash Whorly	
	1.8 AP 8V 4 Cil	●		01/89	12/90	NKBC07510		
					01/89	12/94	NKBC07510	
			●		01/91	12/94	NKBC07910	
		2.0 AP 8V 4 Cil			02/91	12/94	NKBC07510	
		●		02/91	12/92	NKBC07910		
F 100	2.3 8V 4 Cil	●		06/76	12/84	NKBC02300		
	3.0 8V 4 Cil	●		01/60	12/76	NKBC02200		
Itamaraty	3.0 8V 4 Cil	●		01/60	12/76	NKBC02200		
Maverick	2.3 8V 4 Cil	●		01/75	12/79	NKBC02300		

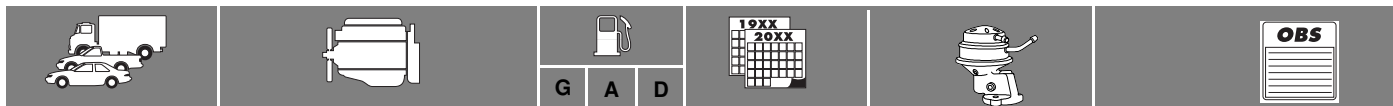

**Veiculos de Passeio & Pick-ups / Vehiculos de Paseo y Camionetas / Passenger Cars & Light Pick-ups**

**FORD**

Maverick	3.0 8V 4 Cil	●		01/73	12/76	NKBC02200	
Pampa	1.6 8V 4 Cil	●		01/78	12/83	NKBC02510	
	1.6 AP 8V 4 Cil	●		01/93	12/96	NKBC07910	
	1.6 CHT 4 Cil	●		01/84	12/90	NKBC02091	
		●		01/84	12/91	NKBC02700	Crash Whorthy
	1.8 AP 8V 4 Cil	●		01/89	12/91	NKBC07510	
Royale				01/89	12/96	NKBC07510	
		●		02/91	12/96	NKBC07910	
	1.8 AP 8V 4 Cil			01/91	12/94	NKBC07510	
		●		01/91	12/94	NKBC07910	
Rural	2.0 AP 8V 4 Cil			01/91	12/94	NKBC07510	
		●		01/91	12/94	NKBC07910	
Verona	2.3 8V 4 Cil	●		01/75	12/80	NKBC02300	
	3.0 8V 4 Cil	●		01/70	12/76	NKBC02200	
Verona	1.6 AE 4 Cil	●		01/90	12/94	NKBC02700	Crash Whorthy
	1.8 AP 8V 4 Cil	●		01/89	12/90	NKBC07510	
				01/89	12/94	NKBC07510	
		●		02/91	12/94	NKBC07910	
	2.0 AP 8V 4 Cil			01/91	12/94	NKBC07510	
Versailles		●		02/91	12/94	NKBC07910	
	1.8 AP 8V 4 Cil			01/91	12/94	NKBC07510	
		●		01/91	12/94	NKBC07910	
	2.0 AP 8V 4 Cil			01/91	12/94	NKBC07510	
		●		01/91	12/94	NKBC07910	

**GENERAL MOTORS**

A/C/D 10	3900 Perkins 4236 4 Cil		●	01/76	12/91	NKBC04100	
	4100 Perkins 4248 4 Cil		●	01/76	12/91	NKBC04100	
A/C/D 20	3900 Perkins Q20B 4236 4 Cil		●	03/89	08/91	NKBC04800	
	4100 Perkins S4 4 Cil		●	09/91	12/01	NKBC04900	
Bonanza	4.1 8V 6 Cil			01/90	12/93	NKBC03711	
Caravan GM	2.5 8V 4 Cil	●		01/76	12/84	NKBC03400	
		●		01/85	12/92	NKBC03711	
	4.1 8V 6 Cil	●		01/76	12/84	NKBC03400	
				01/85	12/92	NKBC03711	
		●		01/85	12/88	NKBC03711	
Chevette	1.0 8V 4 Cil	●		01/92	12/93	NKBC03122	
	1.4 8V 4 Cil	●		01/73	12/82	NKBC03122	
	1.6 8V 4 Cil	●		01/82	12/93	NKBC03122	
Chevy 500	1.4 8V 4 Cil	●		01/73	12/82	NKBC03122	
	1.6 8V 4 Cil	●		01/82	12/93	NKBC03122	
Ipanema	1.8 8V 4 Cil	●		01/89	12/91	NKBC03141	
Kadett	1.8 8V 4 Cil	●		01/89	12/91	NKBC03141	
	2.0 8V 4 Cil	●		01/89	12/91	NKBC03141	
Marajó	1.4 8V 4 Cil	●		01/73	12/91	NKBC03122	
	1.6 8V 4 Cil	●		01/73	12/91	NKBC03122	
Monza	1.6 8V 4 Cil	●		01/82	12/83	NKBC03141	

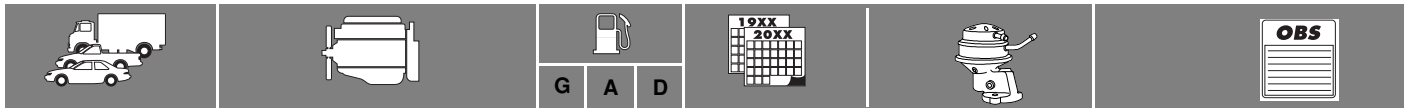

**Veiculos de Passeio & Pick-ups / Vehiculos de Paseo y Camionetas / Passenger Cars & Light Pick-ups**

**GENERAL MOTORS**

Monza	1.8 8V 4 Cil	●		01/82	12/91	NKBC03141	
	2.0 8V 4 Cil	●		09/86	12/91	NKBC03141	
Opala	2.5 8V 4 Cil	●		01/69	12/85	NKBC03400	
		●		01/85	12/92	NKBC03711	
	4.1 8V 6 Cil	●		01/70	12/84	NKBC03400	
		●		01/85	12/88	NKBC03711	
				01/85	12/92	NKBC03711	
Veraneio	4.1 8V 6 Cil	●		01/76	12/84	NKBC03400	
		●		01/85	12/88	NKBC03711	
				01/85	12/93	NKBC03711	

**LADA**

Laika	1.6 8V 4 Cil	●		01/90	12/93	NKBC01300	
Niva	1.6 8V 4 Cil	●		01/92	12/93	NKBC01300	
Samara	1.3 8V 4 Cil	●		01/90	12/93	NKBC01300	
	1.5 8V 4 Cil	●		01/90	12/93	NKBC01300	

**VOLKSWAGEN**

Apollo	1.8 AP 8V 4 Cil	●		01/89	02/91	NKBC07510	
				01/89	12/92	NKBC07510	
		●		02/91	12/92	NKBC07910	
Brasilia	1.6 8V 4 Cil	●		05/75	12/82	NKBC07131	
Fusca	1.3 8V 4 Cil	●		01/68	12/83	NKBC07131	
				01/79	12/83	NKBC07131	
		●		01/75	12/79	NKBC07131	
		●		01/75	12/86	NKBC07131	
				01/84	12/86	NKBC07131	
Gol	1.0 AE 4 Cil	●		01/93	12/96	NKBC02091	Crash Whorthy
		●		01/93	12/96	NKBC02700	
				01/80	12/83	NKBC07131	
		●		01/80	12/86	NKBC07131	
		●		01/89	12/94	NKBC02091	
				01/84	12/94	NKBC07510	
		●		01/84	12/89	NKBC07510	
		●		01/91	12/94	NKBC07910	
		●		01/84	12/89	NKBC07510	
		●		01/84	12/94	NKBC07510	
Karmann Ghia	1.5 8V 4 Cil	●		01/68	12/75	NKBC07131	
Kombi	1.6 8V 4 Cil	●		01/75	12/97	NKBC07131	
Logus	1.8 AP 8V 4 Cil			01/93	12/94	NKBC07510	
		●		01/93	12/94	NKBC07910	
				01/93	12/94	NKBC07510	
		●		01/93	12/94	NKBC07910	
Parati	1.6 AE 4 Cil	●		01/89	12/94	NKBC02091	
		●		01/89	12/94	NKBC02700	Crash Whorthy
		●		01/83	12/89	NKBC07510	
				01/83	12/96	NKBC07510	
		●		01/91	12/96	NKBC07910	

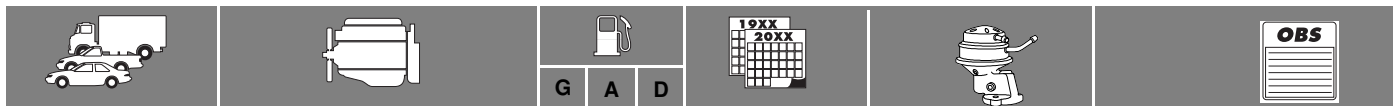

**Veiculos de Passeio & Pick-ups / Vehiculos de Paseo y Camionetas / Passenger Cars & Light Pick-ups**

**VOLKSWAGEN**

Parati	1.8 AP 8V 4 Cil	●		01/83	12/90	NKBC07510	
				01/83	12/96	NKBC07510	
				01/91	12/96	NKBC07910	
Passat	1.5 8V 4 Cil	●		01/74	12/76	NKBC07510	
	1.6 8V 4 Cil	●		01/76	12/89	NKBC07510	
	1.8 8V 4 Cil	●		01/84	12/87	NKBC07510	
Quantum	1.8 AP 8V 4 Cil	●		01/86	12/90	NKBC07510	
				01/86	12/94	NKBC07510	
				01/91	12/96	NKBC07910	
	2.0 AP 8V 4 Cil	●		01/86	12/90	NKBC07510	
				01/91	12/94	NKBC07510	
		●		01/91	12/96	NKBC07910	
Santana	1.8 AP 8V 4 Cil	●		01/86	12/90	NKBC07510	
				01/86	12/94	NKBC07510	
				01/91	12/96	NKBC07910	
	2.0 AP 8V 4 Cil	●		01/86	12/90	NKBC07510	
				01/91	12/94	NKBC07510	
		●		01/91	12/96	NKBC07910	
Saveiro	1.6 AE 4 Cil	●		01/89	12/94	NKBC02091	
				01/89	12/94	NKBC02700	Crash Whorty
	1.6 AP 8V 4 Cil	●		01/84	12/96	NKBC07510	
				01/91	12/96	NKBC07910	
				01/84	12/96	NKBC07510	
		●		01/91	12/96	NKBC07910	
SP-2	1.7 8V 4 Cil	●		01/75	12/76	NKBC07131	
Variant I	1.6 8V 4 Cil	●		01/69	12/77	NKBC07131	
Variant II	1.6 8V 4 Cil	●		01/77	12/82	NKBC07131	
Voyage	1.5 8V 4 Cil	●		01/82	12/84	NKBC07510	
	1.6 AE 4 Cil	●		01/89	12/93	NKBC02091	
				01/89	12/93	NKBC02700	Crash Whorty
	1.6 AP 8V 4 Cil	●		01/84	12/95	NKBC07510	
				01/91	12/95	NKBC07910	
				01/84	12/95	NKBC07510	
1.8 8V 4 Cil	●		01/84	12/90	NKBC07510		
			01/91	12/95	NKBC07910		

**Motor / Motor / Engine**

**M.W.M.**

MWM	4.10 Turbo 4 Cil	●		01/94	12/99	NKBC06200	
	D229 4 Cil	●		01/50	12/06	NKBC06100	
	TD229 4 Cil	●		01/50	12/06	NKBC06100	

**MAXION**

MAXION	S4 4 Cil	●		09/91	12/96	NKBC04800	
--------	----------	---	--	-------	-------	-----------	--

**PERKINS**

Perkins	3152 3 Cil	●		01/62	12/72	NKBC04500	
	4203 4 Cil	●		01/66	12/83	NKBC04400	
	4236 4 Cil	●		01/76	12/91	NKBC04100	
				01/86	12/96	NKBC04200	



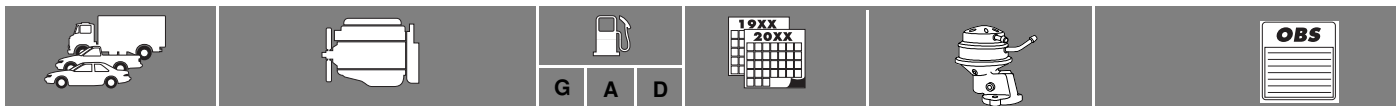

**Motor / Motor / Engine**

**PERKINS**

Perkins	4248 4 Cil		●	01/76	12/91	NKBC04100
			●	01/86	12/96	NKBC04200
	6354 6 Cil		●	01/86	12/96	NKBC04600
	6357 6 Cil		●	01/79	12/86	NKBC04700
	6358 6 Cil		●	01/79	12/86	NKBC04700
	Q20B4236 4 Cil		●	01/81	12/91	NKBC04800
	S4 4 Cil		●	09/91	12/96	NKBC04800
	T4236A 4 Cil		●	01/80	12/90	NKBC04200

**Caminhões & Ônibus / Camiones y Autobuses / Heavy Trucks & Buses**

**AGRALE**

Ultra Van	4100 Perkins S4 4 Cil		●	01/89	12/94	NKBC04100
-----------	-----------------------	--	---	-------	-------	-----------

**FORD**

F 75	2.3 8V 4 Cil	●		06/76	12/84	NKBC02300
	3.0 8V 4 Cil	●		01/60	12/76	NKBC02200

**BROSOL**

BROSOL	Nakata
214131	
216510	
216910	
243122	
243141	
245400	
245711	
251091	
251510	
251700	
252200	
252300	
260100	
260200	
260400	
260500	
260600	
260700	
260800	
260900	
270100	
270200	
280400	
281300	
281500	

**CARTER**

CARTER	Nakata
60208	
60211	
60228	
60249	
60250	
60251	
60252	
60262	
60276	
60278	
60337	
60339	
60340	
60369	
60370	
60376	
60442	
60455	

**CARTER**

CARTER	Nakata
60457	
60459	
60460	
60461	
6732	
6734	
6783	

**FIAT**

FIAT	Nakata
7552503	
7552526	
7656013	
7662758	
7703714	
7718702	

**FORD**

FORD	Nakata
10690	
2612702510	
2612702511	
291270252	
561270252	
561270254	
75BU9350B	
78TU9350A	
80NU9350A	
82BU9350A	
84AU9350D	
84AU9350E	
B10690	
BD4T9350A	
D42E9350AC	

**GENERAL MOTORS**

GENERAL MOT	Nakata
52257318	
52269924	
52272639	
52288625	
52288626	
52288627	
9305729	
93209828	
94621112	
94636436	

**GENERAL MOTORS**

GENERAL MOT	Nakata
94642703	
94644682	
94658977	

**MAXION**

MAXION	Nakata
264109	
2641326	
2641327	
2641371	
2641406	
2641719	
72013	
72023	
72024	
72025	
72027	
72028	
72042	
72061	
72062	
72064	
72068	
72069	
72070	
72081	
72083	
72084	
72085	
72086	
72087	

**MWM**

MWM	Nakata
9052002000040	
9052002000041	

**VOLKSWAGEN**

VOLKSWAGEN	Nakata
2612702510	
2612702511	
311127025A	
4012702516	
4012702517	
4012702518	
4012702522	
4012702524	

**VOLKSWAGEN**

VOLKSWAGEN	Nakata
401270258	
4112702511	
561270252	
561270254	

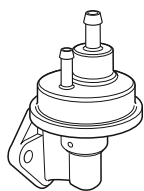

**NKBC01300**

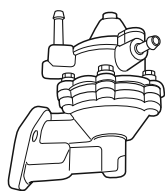

**NKBC01400**

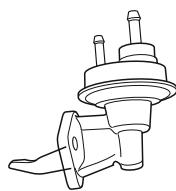

**NKBC01500**

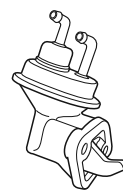

**NKBC02091**

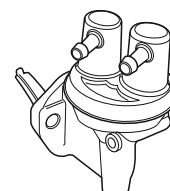

**NKBC02200**

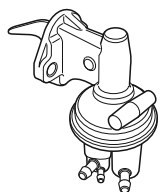

**NKBC02300**

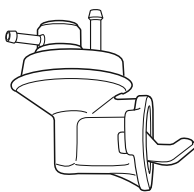

**NKBC02510**

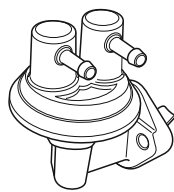

**NKBC02700**



**NKBC03122**



**NKBC03141**

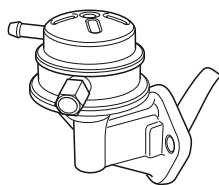

**NKBC03400**

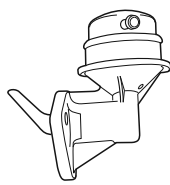

**NKBC03711**

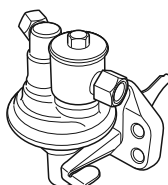

**NKBC04100**

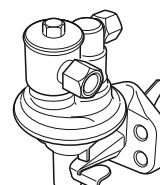

**NKBC04200**

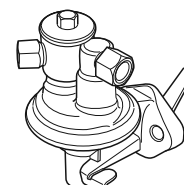

**NKBC04400**

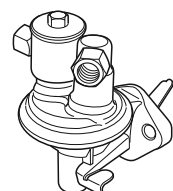

**NKBC04500**

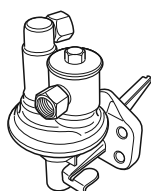

**NKBC04600**

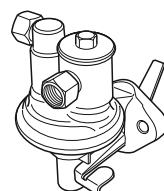

**NKBC04700**

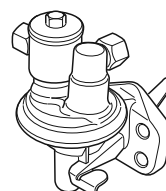

**NKBC04800**

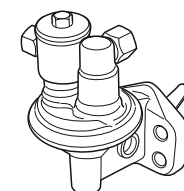

**NKBC04900**

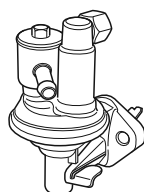

**NKBC06100**

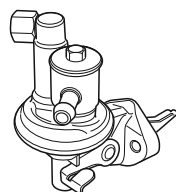

**NKBC06200**

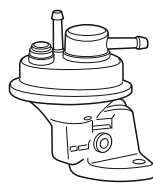

**NKBC07131**

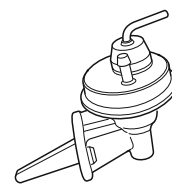

**NKBC07510**

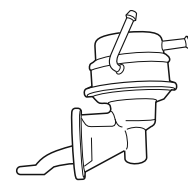

**NKBC07910**

**BROSOL**

BROSOL	Nakata
214131	NKBC07131
216510	NKBC07510
216910	NKBC07910
243122	NKBC03122
243141	NKBC03141
245400	NKBC03400
245711	NKBC03711
251091	NKBC02091
251510	NKBC02510
251700	NKBC02700
252200	NKBC02200
252300	NKBC02300
260100	NKBC04100
260200	NKBC04200
260400	NKBC04400
260500	NKBC04500
260600	NKBC04600
260700	NKBC04700
260800	NKBC04800
260900	NKBC04900
270100	NKBC06100
270200	NKBC06200
280400	NKBC01400
281300	NKBC01300
281500	NKBC01500

**CARTER**

CARTER	Nakata
60208	NKBC04100
60211	NKBC02510
60228	NKBC04200
60249	NKBC04400
60250	NKBC04500
60251	NKBC04600
60252	NKBC04700
60262	NKBC07131
60276	NKBC02091
60278	NKBC02700
60337	NKBC01400
60339	NKBC01300
60340	NKBC01500
60369	NKBC03141
60370	NKBC03400
60376	NKBC03711
60442	NKBC07510
60455	NKBC04800

**CARTER**

CARTER	Nakata
60457	NKBC04900
60459	NKBC06100
60460	NKBC06200
60461	NKBC07910
6732	NKBC02300
6734	NKBC02200
6783	NKBC03122

**FIAT**

FIAT	Nakata
7552503	NKBC01400
7552526	NKBC01400
7656013	NKBC01500
7662758	NKBC01500
7703714	NKBC01300
7718702	NKBC01300

**FORD**

FORD	Nakata
10690	NKBC02200
2612702510	NKBC07910
2612702511	NKBC07910
291270252	NKBC02700
561270252	NKBC07510
561270254	NKBC07510
75BU9350B	NKBC02300
78TU9350A	NKBC02300
80NU9350A	NKBC02510
82BU9350A	NKBC02300
84AU9350D	NKBC02700
84AU9350E	NKBC02700
B10690	NKBC02200
BD4T9350A	NKBC02200
D42E9350AC	NKBC02300

**GENERAL MOTORS**

GENERAL MOT	Nakata
52257318	NKBC03141
52269924	NKBC03711
52272639	NKBC03711
52288625	NKBC03141
52288626	NKBC03122
52288627	NKBC03711
9305729	NKBC03400
93209828	NKBC03711
94621112	NKBC03400
94636436	NKBC03711

**GENERAL MOTORS**

GENERAL MOT	Nakata
94642703	NKBC03122
94644682	NKBC03711
94658977	NKBC03141

**MAXION**

MAXION	Nakata
264109	NKBC04100
2641326	NKBC04400
2641327	NKBC04400
2641371	NKBC04700
2641406	NKBC04500
2641719	NKBC04600
72013	NKBC04100
72023	NKBC04500
72024	NKBC04400
72025	NKBC04700
72027	NKBC04800
72028	NKBC04600
72042	NKBC04200
72061	NKBC04800
72062	NKBC04600
72064	NKBC04100
72068	NKBC04200
72069	NKBC04500
72070	NKBC04700
72081	NKBC04900
72083	NKBC04200
72084	NKBC04500
72085	NKBC04400
72086	NKBC04600
72087	NKBC04800

**MWM**

MWM	Nakata
9052002000040	NKBC06100
9052002000041	NKBC06200

**VOLKSWAGEN**

VOLKSWAGEN	Nakata
2612702510	NKBC07910
2612702511	NKBC07910
311127025A	NKBC07131
4012702516	NKBC07131
4012702517	NKBC07131
4012702518	NKBC07131
4012702522	NKBC07131
4012702524	NKBC07131

**VOLKSWAGEN**

VOLKSWAGEN	Nakata
401270258	NKBC07131
4112702511	NKBC07131
561270252	NKBC07510
561270254	NKBC07510





# NAKATA.COM.BR.

## ACESSE E FAÇA UM TEST DRIVE.



### **Tudo azul na Internet para facilitar e impulsionar os negócios.**

Moderno, completo e interativo, o site da Nakata foi desenvolvido para facilitar a navegação e oferecer mais agilidade na busca por informações de produtos e serviços, até do tablet ou smartphone.

*Catálogo online:  
a peça certa no lugar certo.*

Você encontra tudo organizado, com informação atualizada, consulta por aplicação, referência cruzada e código da montadora.

*E mais!*

- Últimos lançamentos.
- Onde encontrar: rede de oficinas PAC, distribuidores e lojas de autopeças.
- Catálogos em PDF para download.
- TV Nakata com Dicas de Gestão de Negócios, Aulas Técnicas e Manutenção Preventiva.

Para mais aplicações, consulte nosso catálogo eletrônico  
[catalogonakata.com.br](http://catalogonakata.com.br)



**TUDO AZUL. TUDO NAKATA.**



0800 707 80 22 • [nakata.com.br](http://nakata.com.br)

## COM NAKATA É TUDO AZUL PELA FRENTE.

É ALTA PERFORMANCE  
PRA VALER.

flag

### DIREÇÃO E SUSPENSÃO

Amortecedores  
Componentes de Suspensão e Direção



### FREIOS

Pastilhas  
Discos  
Sapatas  
Tambores  
Cubos de Roda



### TRANSMISSÃO

Juntas Homocinéticas  
Cruzetas  
Kits de Reparo



### MOTOR

Bombas d'Água  
Bombas de Óleo  
Bombas de Combustível

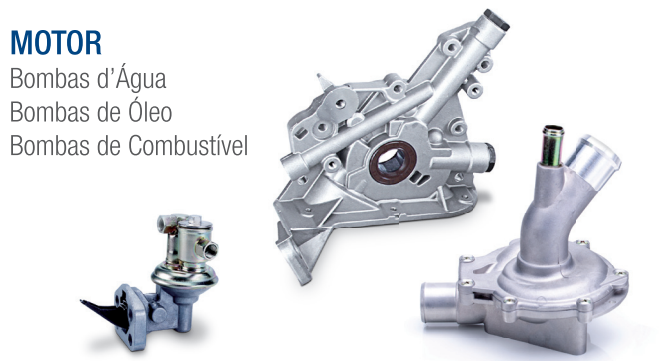

### Garantia de qualidade e segurança na linha leve.

Reconhecida pela sua liderança em sistemas de suspensão, a Nakata aplica a mesma qualidade, tecnologia e confiança em todo seu portfólio de produtos. Quem quer alta performance, pede Nakata.



TUDO AZUL. TUDO NAKATA.



0800 707 80 22 • nakata.com.br