



ROMETAL Soluções & Alumínio

MANUAL DE MONTAGEM
MANUAL DE INSTALACIÓN

RO 62 | RO 65

Cód.: 10319 | Rev.: 01



Portas de até
Puertas hasta
60kg



Portas de
Puertas de
15 - 25mm

COMPONENTES DO KIT PARA 01 PORTA
COMPONENTES DEL KIT PARA 01 PUERTA

02 Carros deslizadores - 02 Freios - 02 Guias
02 Carros corredizos - 02 Frenos - 02 Guias
Parafusos indicados/Tornillos indicados:
Carros Inferiores/Carros Inferiores: 3,5 x 14 CC
Guias e Freios/Guias y Frenos: 3,5 x 22 CC

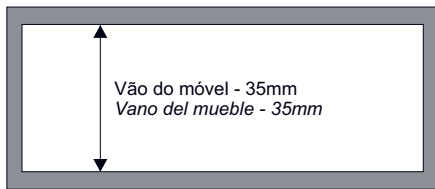

O transpasse indicado entre portas é de 20 a 30mm
El transpaso indicado entre puertas es de 20 hasta 30mm



MONTADOR, SIGA ESTAS INSTRUÇÕES COM ATENÇÃO.
MONTADOR, SIGA LAS INSTRUCCIONES CON ATENCIÓN.

**TABELA DE
ESPAÇAMENTOS
ENTRE PORTAS**

**TABLA DE
ESPACIOS
ENTRE PUERTAS**

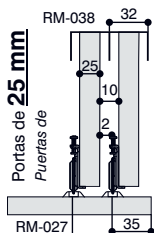
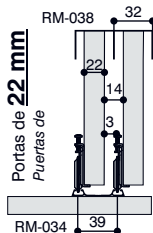
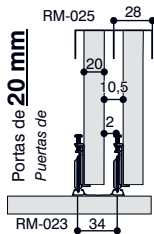
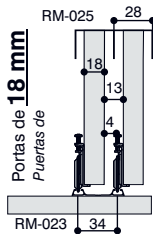
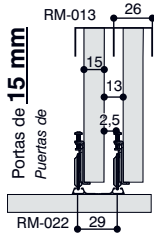

Espessuras de portas e guias
Espesor de puertas y guías

Guia/Guia	Imagem/Imagen	Espes.
RO 624002 RO 65 Plus Ø 25,8mm		15mm
4011 Ø 27,8mm		18 - 20mm
4012 Ø 31,8mm		22mm
4013 Ø 27,3mm		18 - 20mm
4025		15 - 25mm
4026		15 - 25mm
Universal 4030 4031		15 - 25mm

1

Faça as furações e instale os carros.
(medidas em mm)
Hacer los agujeros y fijar los carros. (medidas en mm)

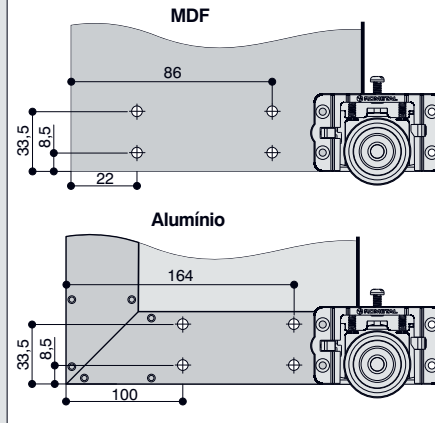

2

Instale os guias/*Fijar los guías*

Guias/Guias
4002/4011/4012/4013

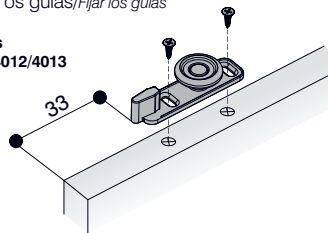

Guia Universal/Guía Universal

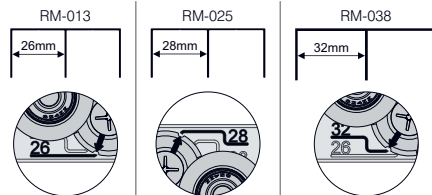

Fixe a parte móvel/Fije la parte móvil

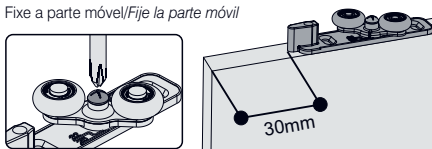

Se utilizado com o amortecedor Comfort 240, consulte o manual do amortecedor.

Si utilizado con amortiguador Comfort 240, consulte el manual del amortiguador.

O guia deve ficar centralizado na porta.
El guía debe quedarse centralizado en la puerta.

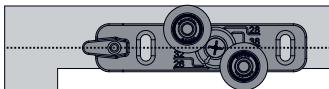
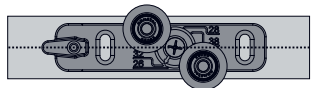

Guia 4025/4026 / Guía 4025/4026

Permite a regulagem de acordo com a espessura da porta.
Permite la regulaje de acuerdo con el espesor de la puerta.

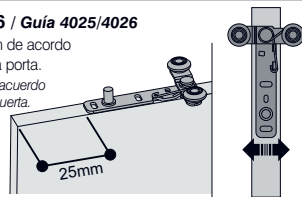

Gire a parte móvel até o limite e levante sua parte superior para travar.
Gire la parte móvil hasta el límite y levante la parte superior para trabar.

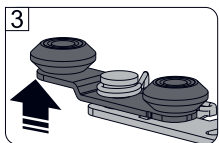
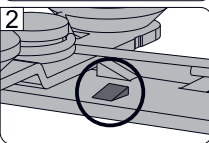
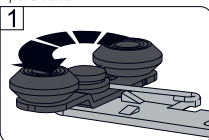

3 Instale os trilhos/Instale los rieles

Fazer a furação no centro do trilho
Hacer la perforación en el centro del riel

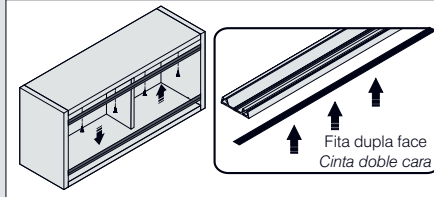
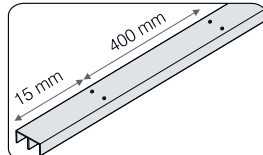

4 Fixar o freio junto ao trilho superior Fijar el freno junto con el riel superior.

Regule a distância do freio conforme o fechamento desejado.

Ajuste la distancia del freno de acuerdo con el cierre deseado.

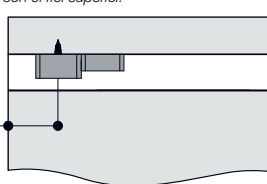

5 Encaixar as portas/Encaje las puertas

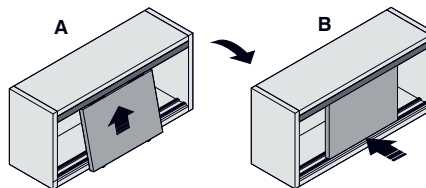

Para o guia 4025/4026, erga a porta até a mesma encostar no topo do trilho para destravar o guia.
Para el guía 4025/4026, levante hasta que el guía sea forzado contra la parte superior del riel, para destrabar el guía.

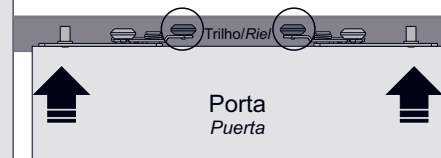

6 Sistema de travamento e regulagem de altura da porta./Sistema de traba y regulación de altura de la puerta.

Para destravar as molas, solte o parafuso superior.
Para desbloquear los muelles, alaje el tornillo superior.

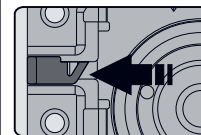

Destravar as molas.
Desbloquear los muelles.

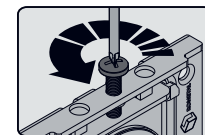

Regular a altura da porta no deslizador inferior.
Regular la altura de la puerta en el deslizador inferior.



Rodovia BR 470 | Km 174,5 | Nº 4075
Bairro Universal | CEP 95330-000
Veranópolis | RS | Brasil
Fone +55 54 3441 3100
atendimento@rometal.com.br

www.rometal.com.br